

REPAIR MANUAL



SELF PROPELLED LIFT HA20 PX - HA26PX

242 031 9530 - E 02.03 GB



ISO 9001
GROUPE
PINGUELY
HAULOTTE



ARTICULEES



MATS



TELESCOPIQUES



CISEAUX



TRACTEES

Haulotte 

L'ACCES A L'ESPACE

PINGUELY HAULOTTE • LA PERONNIERE - BP 9 - 42152 L'HORME • Tél. +33 (0) 4 77 29 24 24 • Fax SAV +33 (0) 4 77 31 28 11
email haulotte@haulotte.com • Web www.haulotte.com

GENERAL

This manual gives the information required for you to perform servicing and repair operations on certain pieces of equipment yourself.

However, we would like to bring your attention to the importance of:

- respecting the safety instructions concerning the machine itself, its use and its environment,
- use within the limits of its performance,
- correct servicing to ensure long service life.

During and after the guarantee period, our After-Sales service is available to perform any servicing operations you may require.

In this case, contact our local agency or our Plant After-Sales service, specifying the exact type of machine and its serial number.

To order consumables or spare parts, use the "Instructions for use and maintenance" manual and the "Spare parts" catalogue to order original parts, the only guarantee of interchangeability and perfect operation.

REMINDER: We would like to remind you that our machines comply with the clauses of the "Machines Directive", 89/392/CEE, dated June 14th 1989, modified by directives 91/368/CEE, dated June 21st 1991, 93/44/CEE, dated June 14th 1993, 93/68/CEE (98/37/CE) dated July 22nd 1993 and 89/336 CEE, dated May 3rd 1989; to directive 2000/14/CE and directive EMC/89/336/CE.



Caution!

The technical data in this manual is not binding and we reserve the right to make improvements or modifications without altering this manual.

SUMMARY

GENERAL	1
1 - GENERAL RECOMMENDATIONS - SAFETY	5
1.1 - GENERAL WARNING	5
1.1.1 - Manual	5
1.1.2 - Labels	5
1.1.3 - Safety.....	5
1.2 - GENERAL SAFETY RECOMMENDATIONS	6
1.2.1 - Operators	6
1.2.2 - Environment.....	6
1.2.3 - Using the machine	6
1.3 - RESIDUAL RISKS	8
1.3.1 - Risks of jerky movements and tipping over	8
1.3.2 - Electrical risk.....	8
1.3.3 - Risk of explosion or burning.....	8
1.3.4 - Risks of collision	8
1.4 - INSPECTIONS	9
1.4.1 - Periodic inspections	9
1.4.2 - Examination of machine suitability.....	9
1.4.3 - State of conservation	9
1.5 - REPAIRS AND ADJUSTMENTS.....	10
1.6 - VERIFICATIONS WHEN RETURNING TO SERVICE	10
1.7 - BEAUFORT SCALE	10
2 - SPECIFICATIONS	11
2.1 - TECHNICAL CHARACTERISTICS	11
2.1.1 - HA 20PX technical characteristics	11
2.1.2 - HA 26PX technical characteristics	12
2.2 - OVERALL DIMENSIONS	14

2.2.1 - HA 20PX overall dimensions.....	14
2.2.2 - HA 26PX overall dimensions.....	15
2.3 - TIGHTENING TORQUE.....	16
2.3.1 - Tightening torque for large thread.....	16
2.3.2 - Tightening torque for fine thread.....	16
2.3.3 - Tightening torque for hydraulic hoses.....	17
2.3.4 - Pressure values (in bar).....	18
2.3.5 - Adjustment time.....	19
3 - SAFETY SYSTEM.....	21
3.1 - FUNCTIONS OF THE TURRET CABINET FUSES AND RELAYS.....	21
3.2 - FUNCTION OF THE SAFETY SWITCHES.....	21
4 - WIRING DIAGRAM.....	23
4.1 - WIRING DIAGRAM E 448 - FOLIO 01/05.....	23
4.2 - WIRING DIAGRAM E 448 - FOLIO 02/05.....	24
4.3 - WIRING DIAGRAM E 448 - FOLIO 03/05.....	25
4.4 - WIRING DIAGRAM E 448 - FOLIO 04/05.....	26
4.5 - WIRING DIAGRAM E 448 - FOLIO 05/05.....	27
4.6 - PART LIST.....	28
5 - MACHINES ELEMENTS.....	31
5.1 - MOTOR.....	31
5.2 - FUSES.....	31
5.3 - INPUT.....	31
5.3.1 - Control inputs :.....	31
5.3.2 - Safety inputs :.....	33
5.4 - OUTPUT.....	33
5.4.1 - Relay.....	33
5.4.2 - "On/Off" electrovalves.....	33
5.4.3 - Proportional electrovalves.....	34

5.4.4 - Buzzer and light indicators	34
6 - OPERATING EQUATIONS	35
6.1 - START	35
6.2 - STOP MOTEUR	35
6.3 - ACCELERATOR.....	35
6.4 - COMPENSATION.....	35
6.5 - ROTATION	35
6.6 - JIB.....	36
6.7 - ROTATION	36
6.8 - ARM LIFTING	36
6.9 - BOOM LIFTING	37
6.10 - TELESCOPING	37
6.11 - TRAVEL.....	37
6.12 - STEERING	37
6.13 - DIFFERENTIAL BLOCKING.....	38
6.14 - HORN - BUZZER.....	38
6.15 - INDICATORS.....	38
6.16 - OTHER FUNCTIONS : OVERLOAD, DEAD MAN, SLOPE	39
6.16.1 - Overload	39
6.16.2 - Dead man	39
6.16.3 - Slope.....	39
6.17 - HA26P REACH LIMIT.....	39
7 - SAFETY LOCATION.....	41
8 - POSITIONS OF ELECTRIC COMPONENTS	43
8.1 - MOTHER BOARD	43
8.1.1 - Description.....	43

8.1.2 - Positions of screws, connectors and relays	44
8.1.3 - Positions of fuses	45
8.1.4 - Positions of diagnosis help LEDs	46
9 - HYDRAULIC DIAGRAMS	47
9.1 - HYDRAULIC DIAGRAM FOR HA20/26PX AND HA61/80JRT MODELS (B1539)0 ..	47
10 - HYDRAULICS COMPONENTS DESCRIPTION	49
10.1 - TRAVEL BLOCK	49
10.1.1 - Location	49
10.1.2 - Input and output	51
10.2 - PVG 32 DANFOSS BLOCK	52
10.2.1 - Location	52
10.2.2 - Input and output	53
10.3 - CETOP 3 AUXILIARY BLOCK	54
10.3.1 - Location	54
10.4 - EMERGENCY PUMP UNIT	55
10.4.1 - Location	55
10.5 - TELESCOPING BLOCK	56
10.5.1 - Location	56
10.6 - STEERING BLOCK CONTROL	57
10.6.1 - Location	57
10.6.2 - Input and output	57
11 - HYDRAULIC EQUATIONS	59
11.1 - TRAVEL	59
11.2 - TURNTABLE ROTATION	59
11.3 - ARM LIFTING	59
11.4 - BOOM LIFTING	59
11.5 - TELESCOPING	59
11.6 - OTHER MOVEMENT	59

12 - MAINTENANCE	61
12.1 - GENERAL RECOMMENDATIONS	61
12.2 - PARTICULAR RECOMMENDATIONS.....	61
12.2.1 - Specific tools.....	61
12.2.2 - Replacing an element	62
12.2.3 - Locating the breakdown.....	62
12.3 - MAINTENANCE SYSTEM.....	62
12.4 - ELECTRIC POWER SUPPLY	63
12.5 - MAINTENANCE PLAN	64
12.6 - OPERATIONS.....	66
12.6.1 - Summary table.....	66
12.7 - PRESENCE OF LABELS	67
12.7.1 - Common "yellow" label	67
12.7.2 - Common "orange" label	68
12.7.3 - Common "red" label	69
12.7.4 - Other common label.....	70
12.7.5 - Model-specific labels.....	71
12.7.6 - Description	72
12.7.7 - Label positioning	73
12.8 - PRESENCE OF MANUALS.....	74
13 - PREVENTIVE MAINTENANCE SHEET	75
14 - OPERATING INCIDENTS.....	83
14.1 - INCIDENT TABLE	83
14.1.1 - General operation	84
14.1.2 - Lifting system.....	86
14.1.3 - Travel system.....	87
14.1.4 - Steering system	88
14.1.5 - Turntable rotation system	88
14.2 - BREAKDOWN DETECTION FLOW CHART.....	88

15 - CORRECTIVE MAINTENANCE PROCEDURES..... 177

1 - GENERAL RECOMMENDATIONS - SAFETY

1.1 - GENERAL WARNING

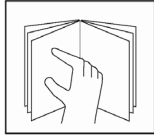

1.1.1 - Manual

This manual aims to help maintenance personnel service and repair the machine. It cannot, however, replace the basic training required by any person working on the site equipment.

The site manager must inform operators of the recommendations in the instruction manual. He is also responsible for application of current "user regulations" in the country of use.

Before operating on the machine, it is essential to be familiar with all the recommendations in this manual and the user manual to ensure personnel and equipment safety.

1.1.2 - Labels

Potential dangers and recommendations for the machine are indicated on labels and plates. Read the instructions on them.

All labels conform to the following colour code:

- Red indicates a potentially fatal danger.
- Orange indicates a danger that may cause serious injury.
- Yellow indicates a danger that may cause material damage or slight injury.

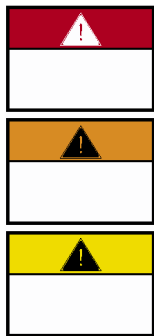

Maintenance personnel must ensure that these labels and plates are in good conditions and keep them legible. Spare labels and plates can be supplied by the manufacturer on request.

1.1.3 - Safety

Ensure that any person entrusted with the machine is take the safety measures implied by its use.

Avoid any working mode that may affect safety. Any use that does not comply with the recommendations may generate risks and damage to people and equipment.

After intervention, maintenance personnel must check that the operator manual is present. This must be kept by the user throughout the machine's service life, even if it is loaned, rented or sold.

Ensure that all the plates or labels related to safety and danger are complete and legible.



Caution!

To attract the reader's attention, instructions are indicated by this standardised sign.

1.2 - GENERAL SAFETY RECOMMENDATIONS

1.2.1 - Operators

Operators must be aged 18 or over and hold an operating permit issued by the employer after verification of medical aptitude and the practical platform operation test.

 **Caution!**
Only trained operators may use Haulotte self-propelled platforms.

There must be at least two operators present, so that one of them can:

- intervene rapidly if necessary,
- take over the controls in the case of accident or breakdown,
- monitor and prevent machines or people from circulating around the platform,
- guide the platform operator if necessary.

1.2.2 - Environment

Never use the machine:

- On soft, unstable or cluttered floors.
- On a floor with a tilt greater than the allowed limit.
- With a windspeed above the permitted level. In case of outdoor use, check that windspeed is lower or equal to the permitted level using an anemometer.
- Near electric lines (find out about minimum distances according to current). In temperatures of less than -15°C (in particular, in cold rooms); consult our service department if work is required in conditions below -15°C .
- In an explosive atmosphere.
- In an incorrectly ventilated area, as exhaust fumes are toxic.
- During storms (risk of being struck by lightning).
- At night if the machine is not equipped with an optional light.
- In the presence of intense electromagnetic fields (radar, mobile and high current).

DO NOT DRIVE ON THE PUBLIC HIGHWAY.

1.2.3 - Using the machine

It is important to ensure that in normal use, i.e. platform operation, the platform station selection key remains in the the platform position to enable control of the machine from the platform. If a problem occurs on the platform, a person present and trained in emergency/standby manoeuvres can help by putting the key in the ground control position.

Never use the machine with:

- a load greater than the nominal load,
- more people than the authorised number,
- lateral force in the platform greater than the level permitted,
- wind speed higher than the permitted level.



To avoid all risk of serious fall, operators must respect the following instructions:

- Hold the hand rails firmly when climbing onto or operating the platform.
- Wipe any traces of oil or grease off the steps, floor and hand rails.
- Wear protective clothing suited to working conditions and current local legislation, in particular when working in hazardous areas.
- Do not disable the safety system end of stroke contactors.
- Avoid contact with fixed or mobile obstacles.
- Do not increase working height by using ladders or other accessories.
- Never use the hand rails as a means of access for getting onto and off the platform (use the steps provided on the machine).
- Never climb on the hand rails when the platform is raised.
- Never drive the platform at high speed in narrow or cluttered areas.
- Never use the machine without installing the platform protective bar or closing the safety barrier.
- Never climb on the covers.



Caution!

Never use the platform as a crane, goods lift or elevator. Never use the platform or tow or haul.



To avoid risks of tipping over, operators must respect the following instructions:

- Do not disable the safety system end of stroke contactors.
- Avoid moving the steering control levers in the opposite direction, without stopping in the "O" position (to stop during a travel manoeuvre, move the manipulator lever gradually).
- Respect maximum load and maximum number of people authorised on the platform.
- Distribute the load evenly and place in the centre of the platform if possible.
- Check that the floor resists the pressure and load per wheel.
- Avoid contact with fixed or mobile obstacles.
- Do not drive the platform at high speed in narrow or cluttered areas.
- Do not drive the platform in reverse (inadequate visibility).
- Do not use the machine if the platform is cluttered.
- Do not use the machine with equipment or objects hanging from the hand rails.
- Do not use the machine with elements that may increase the wind load (e.g. panels).
- Do not perform machine maintenance operations when the machine is raised without setting up the required safety means (gantry crane, crane).
- Make daily checks and monitor proper operation during periods of use.
- Preserve the machine from any uncontrolled operation when it is not in service.

NB: Do not tow the platform (it is not designed to be towed and must be transported on a trailer).

1.3 - RESIDUAL RISKS



Caution!

The direction of travel can be reversed after a 180° turntable rotation. Take account of the colour of the arrows on the chassis compared with the direction of travel (green = forward, red = reverse)

Thus, moving the manipulator in the direction of the green arrow on the control panel will move the machine according to the direction indicated by the green arrow on the chassis. Similarly, moving a manipulator in the direction of the red arrow on the control panel, will move the machine in the direction of the red arrow on the chassis



Caution!

If the machine has a 220 V 16A max. plug, the extension must be connected to a mains socket protected by a 30 mA differential circuit breaker.

1.3.1 - Risks of jerky movements and tipping over

Risks of jerky movement and tipping over are high in the following situations:

- Sudden action on the controls.
- Overloading of the platform.
- Uneven ground (Be careful during thaw periods in winter).
- Gusts of wind.
- Contact with an obstacle on the ground or at a height.
- Working on platforms, pavements, etc.

Allow sufficient stopping distances:

- 3 meters at high speed,
- 1 meter at low speed.

Allow sufficient stopping distances: 3 metres at high speed and 1 metre at low speed.

Do not alter or neutralise any components connected in any way to the machine's safety or stability.

Do not place or fasten a load so that it overhangs the machine's parts.

Do not touch adjacent structures with the elevator arm.

1.3.2 - Electrical risk

Electrical risks are high in the following situations:

- Contact with a live line (check safety distances before operation near electricity lines).
- Use during storms.

1.3.3 - Risk of explosion or burning

The risks of explosion or burning are high in the following situations:

- Working in explosive or inflammable atmosphere.
- Filling the fuel tank near naked flames.
- Contact with the hot parts of the motor.
- Use of a machine generating hydraulic leakage.

1.3.4 - Risks of collision

- Risk of crushing people in the machine operation zone (when travelling or manoeuvring equipment).
- The operator must assess the risks above him before using the machine.
- Pay attention to the position of the arms during turntable rotation.
- Adapt movement speed to conditions related to the ground, traffic, slope and movement of people, or any other factor that may cause a collision.
- When driving down the ramp of a truck, ensure sufficient space is available for safe unloading.
- Check brake pad wear regularly to avoid all risk of collision.

1.4 - INSPECTIONS

Comply with the national regulations in force in the country of machine use.

For FRANCE: Order dated 9 June 1993 + circular DRT 93 dated 22 September 1993 which specify:

1.4.1 - Periodic inspections

The machine must be inspected every 6 months in order to detect any defects liable to cause an accident.

These inspections are performed by an organisation or personnel specially designated by the site manager and under his responsibility (whether or not they belong to the company) Articles R 233-5 and R 233-11 of the French Labour Code.

The results of these inspections are recorded in a safety register kept by the site manager and constantly available to the labour inspector and the site safety committee (if one exists) and the list of specially designated personnel (Article R 233-5 of the French Labour Code).

Moreover, before each use, check the following:

- the operator's manual is in the storage compartment on the platform,
- the stickers are placed according to the section concerning "Labels and their positions",
- oil level and any elements in the maintenance operation table
- look out for any damaged, incorrectly installed, modified or missing parts.

NOTE : *This register can be obtained from trade organisations, and in some cases from the OPPBTP or private prevention agencies.*

The designated persons must be experienced in risk prevention (Articles R 233-11 or order n° 93-41).

No member of personnel is allowed to perform any check whatsoever during machine operation (Article R 233-11 of the French Labour Code).

1.4.2 - Examination of machine suitability

The manager of the site where the machine is operated must ensure the machine is suitable, i.e. capable of performing the work in complete safety, and in compliance with the operating manual. Furthermore, the French order of 9 June 1993 addresses problems relative to leasing, examination of the state of conservation, checking upon operation after repairs, and test conditions (static test coefficient 1.25; dynamic test coefficient 1.1). All users must consult this order's requirements and comply with them.

1.4.3 - State of conservation

Detect any deterioration liable to cause hazardous situations (concerning safety devices, load limiters, tilt sensor, cylinder leaks, deformation, welds, bolt tightness, hoses, electrical connections, tyre state, excessive mechanical gaps).

NOTE : *If the machine is rented/leased, the user responsible for the machine must examine its state of conservation and suitability. He must obtain assurance from the leaser that general periodic inspections and pre-operation inspections have been performed.*

1.5 - REPAIRS AND ADJUSTMENTS

These cover major repairs, and work on or adjustments to safety systems or devices (of a mechanical, hydraulic or electrical nature).

These must be performed by personnel from or working for PINGUELY-HAULOTTE who will use only original parts.

Any modification not controlled by PINGUELY-HAULOTTE is unauthorised.

The manufacturer cannot be held responsible if non-original parts are used or if the work specified above is not performed by PINGUELY-HAULOTTE-approved personnel.

1.6 - VERIFICATIONS WHEN RETURNING TO SERVICE

To be performed after:

- extensive disassembly-reassembly operation,
- repair affecting the essential components of the machine,
- any accident caused by the failure of an essential component.

It is necessary to perform a suitability examination, a state of conservation examination, a static test, a dynamic test (see coefficient in paragraph (see Chap 1.4.2, page 9).



Caution!

These test must be performed by a competent person.

1.7 - BEAUFORT SCALE

The Beaufort Scale of wind force is accepted internationally and is used when communicating weather conditions. It consists of number 0 - 17, each representing a certain strength or velocity of wind at 10m (33 ft) above ground level in the open.

Description of Wind	Specifications for use on land	MPH	m/s
0 Calm	Calm; smoke rises vertically	0-1	0-0.2
1 Light Air	Direction of wind shown by smoke	1-5	0.3-1.5
2 Light Breeze	Wind felt on face; leaves rustle; ordinary vanes moved by wind	6-11	1.6-3.3
3 Gentle Breeze	Leaves and small twigs in constant motion; wind extends light flag	12-19	3.4-5.4
4 Moderate Breeze	Raises dust and loose paper; small Branches are moved	20-28	5.5-7.9
5 Fresh Breeze	Small trees in leaf begin to sway; crested wavelets form on inland waterways	29-38	8.0-10.7
6 Strong Breeze	Large branches in motion; whistling heard in telephone wires; umbrellas used with difficulty	39-49	10.8-13.8
7 Near Gale	Whole trees in motion; inconvenience felt when walking against wind	50-61	13.9-17.1
8 Gale	Breaks twigs off trees; generally impedes progress	62-74	17.2-20.7
9 Strong Gale	Slight structural damage occurs (chimney pots and slates removed)	75-88	20.8-24.4

2 - SPECIFICATIONS

HA 20PX and HA 26PX self-propelled lifts are designed for any high work within the limit of their characteristics and complying with all the safety instructions particular to the machine and to the locations where it is used.

The main operating post is in the «basket».

The turret operating post is an emergency or back-up post.

2.1 - TECHNICAL CHARACTERISTICS

2.1.1 - HA 20PX technical characteristics

DESIGNATIONS	HA 20PX
Load	250 kg, including 2 peoples
Maximum lateral manual force	40 kg
Max. wind speed	60 km/h
Floor height	18,65 m
Working height	20,65 m
Overall length	9,00 m
Overall width	2,35 m
Overall height	2,67 m
Wheelbase	2,60 m
Ground clearance	420 mm
max. reach	13,50 m
Boom range	0° + 75°
Telescoping (stroke)	4200 mm
Turret rotation	Continuous
Max. force on wheel	6194 daN
Reducer (efficiency = 95%)	30
Max. travel slope	40%
Tyre sizes	15 - R22
Outside turning radius	3,9 m
Tilt - Monitor	5° (≈ 9%)
Hydraulic reservoir	150 litres
Diesel tank	150 litres
Total weight	12 260 kg
Number of drive wheels	4
Number of steered wheels	4
Differential lock	YES
Hydraulic brakes	YES
Freewheeling	YES
Wheel nut tightening torque	32 mdaN
Slewing ring nuts tightening torque	27 mdaN
Vibration level at feet	< 0,5/s ²
Vibration level at hands	< 2,5/s ²
DEUTZ diesel engine	F4L 1011 F
Power	51.6 HP / 38 kW at 2400 rpm
Idling power output	20.4 HP / 15 kW at 1250 rpm
Consumption	230 g/kWh
Idling consumption	230 g/kWh
45 cm ³ /rev LOADSENSING hydraulic pump	85 l/min max.

DESIGNATIONS	HA 20PX
Hydraulic pressure:	
General	240 bar
Travel	240 bar
Steering	240 bar
Slewing	100 bar
Equipment	240 bar
Travel speed (proportional)	LS: 1.2 km/h HS: 4.5 km/h
max. ground pressure with 250 kg	
-hard ground (concrete)	14,0 daN/cm ²
-loose ground (mud)	4,3 daN/cm ²
Starting battery	1 X 12 V - 95 Ah
Supply voltage	12 V
Acoustic power	108 dB (A)
Noise level at 10 meters	73.9 dB (A)

2.1.2 - HA 26PX technical characteristics

DESIGNATIONS	HA 26PX
Load	230 kg, including 2 peoples
Maximum lateral manual force	40 kg
Max. wind speed	45 km/k
Floor height	24,00 m
Working height	26,00 m
Overall length	11,90 m
Overall width	2,35 m
Overall height	2,67 m
Wheelbase	2,60 m
Ground clearance	420 mm
max. reach	14,6 m
Boom range	0° + 75°
Telescoping (stroke)	6915 mm
Turret rotation	Continuous
Reducer (efficiency = 95%)	30
Max. travel slope	40%
Tyre sizes	15 - R22
Outside turning radius	3,9 m
Tilt - Monitor	3°
Hydraulic reservoir	150 litres
Diesel tank	150 litres
Total weight	14 150 kg
Number of drive wheels	4
Number of steered wheels	4
Differential lock	YES
Hydraulic brakes	YES
Freewheeling	YES
Wheel nut tightening torque	32 mdaN
Slewing ring nuts tightening torque	27 mdaN
Vibration level at feet	< 0,5/s ²
Vibration level at hands	< 2,5/s ²
DEUTZ diesel engine	F4L 1011 F
Power	51.6 HP / 38 kW at 2400 rpm
Idling power output	20.4 HP / 15 kW at 1250 rpm
Consumption	230 g/kWh
Idling consumption	230 g/kWh
45 cm ³ /rev LOADSENSING hydraulic pump	85 l/min max.

DESIGNATIONS	HA 26PX
Hydraulic pressure:	
General	240 bar
Travel	240 bar
Steering	240 bar
Slewing	100 bar
Equipment	240 bar
Travel speed (proportional)	LS: 1.2 km/h HS: 4.5 km/h
max. ground pressure with 250 kg	
-hard ground (concrete)	16,0 daN/cm ²
-loose ground (mud)	4,6 daN/cm ²
Max. force on wheel	6970 daN
Starting battery	1 X 12 V - 95 Ah
Supply voltage	12 V
Acoustic power	108 dB (A)
Noise level at 10 meters	73.9 dB (A)

2.2 - OVERALL DIMENSIONS

2.2.1 - HA 20PX overall dimensions

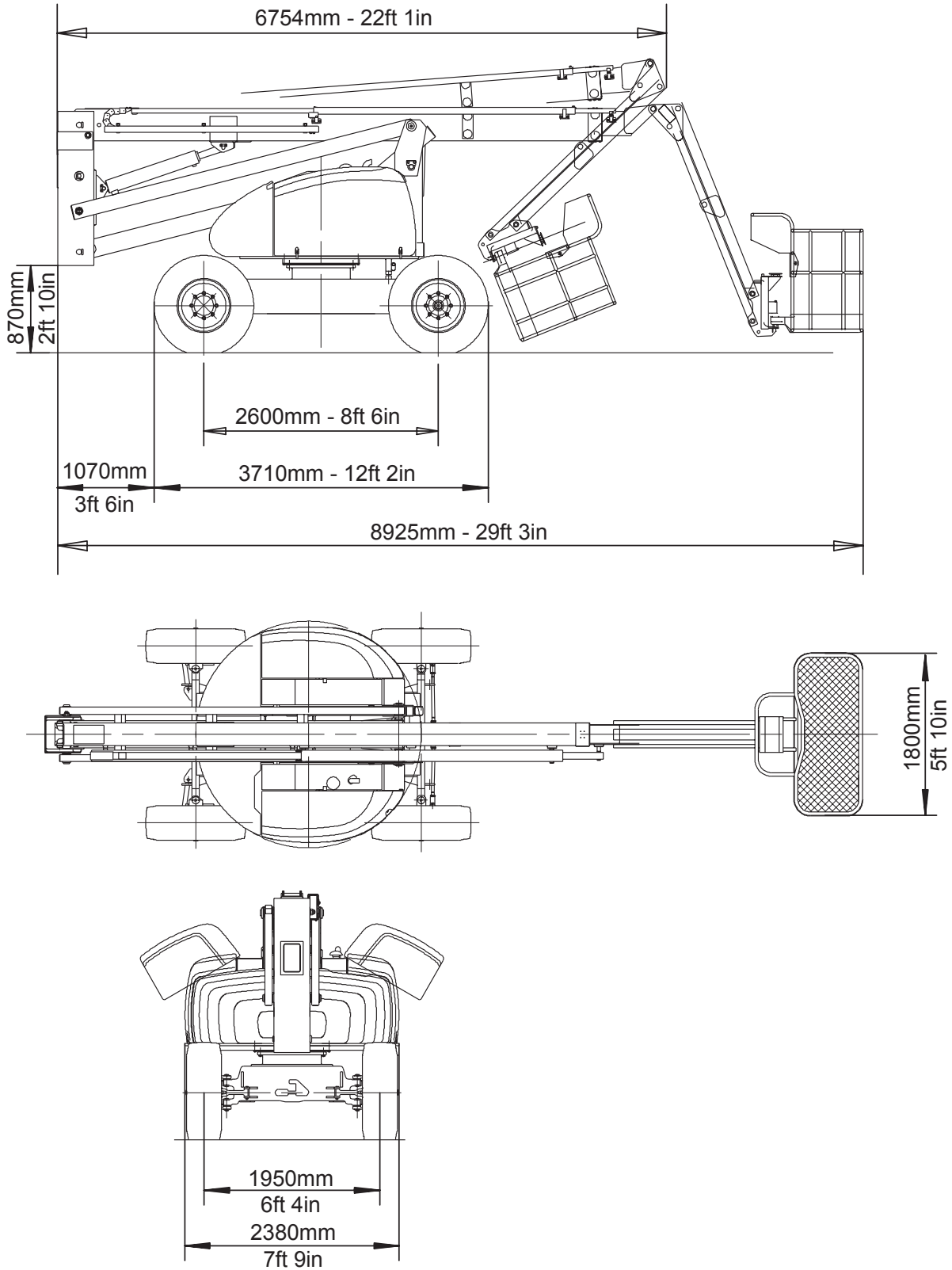

2.2.2 - HA 26PX overall dimensions

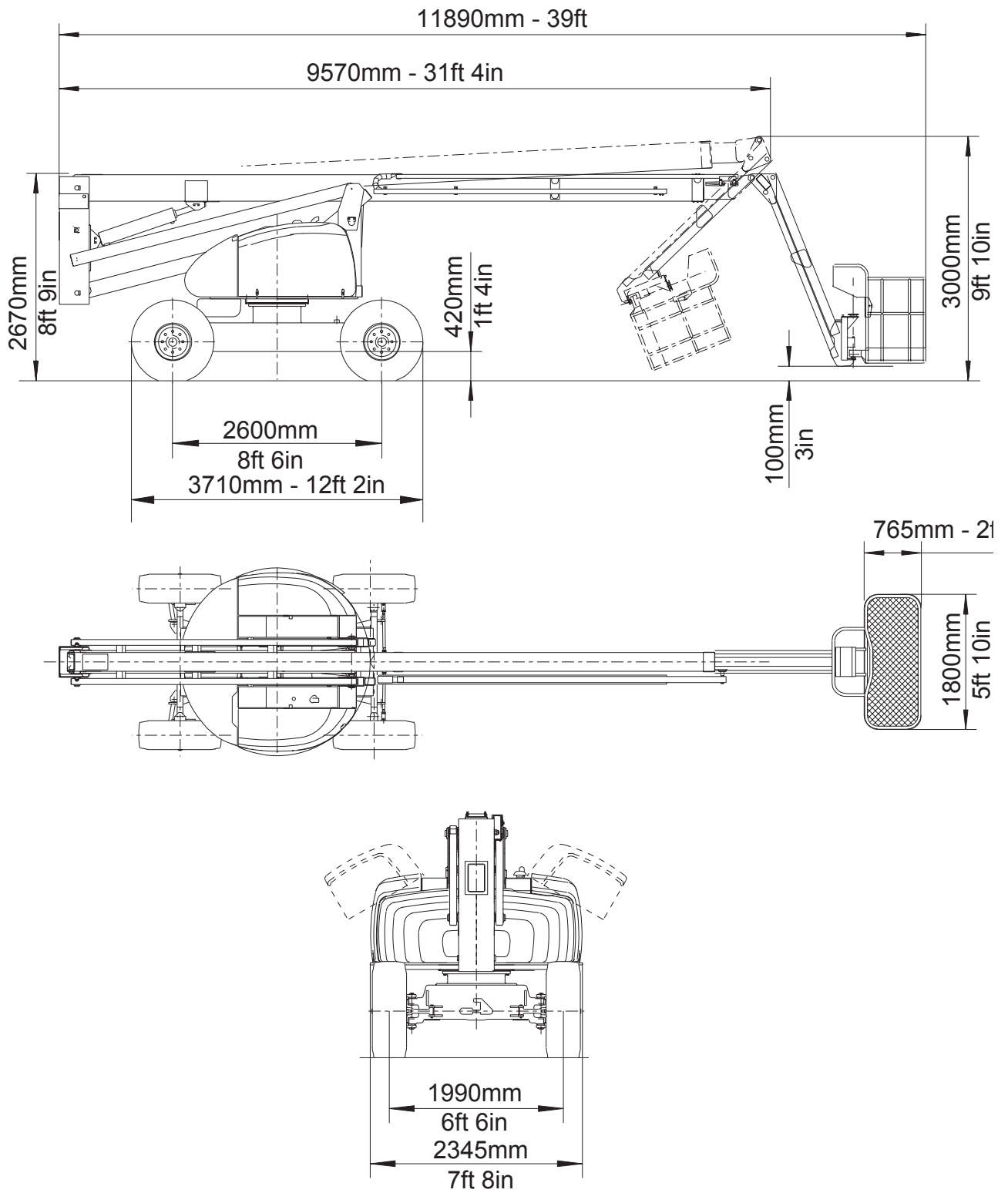

2.3 - TIGHTENING TORQUE

2.3.1 - Tightening torque for large thread

<i>Nominal diameter</i>	<i>Tightening torque in N.M</i>		
	8.8	10.9	12.9
M 6*1	9 à 11	13 à 14	15 à 17
M 7*1	15 à 19	21 à 24	26 à 28
M 8*1.25	22 à 27	31 à 34	37 à 41
M 10*1.5	43 à 45	61 à 67	73 à 81
M 12*1.75	75 à 94	110 à 120	130 à 140
M 14*2	120 à 150	170 à 190	200 à 220
M 16*2	190 à 230	260 à 290	320 à 350
M 18*2.5	260 à 320	360 à 400	440 à 480
M 20*2.5	370 à 450	520 à 570	620 à 680
M 22*2.5	500 à 620	700 à 770	840 à 930
M 24.3*3	630 à 790	890 à 990	1070 à 1180
M 27*3	930 à 1150	1300 à 1400	1560 à 1730
M 30*3.5	1260 à 1570	1770 à 1960	2200 à 2350

2.3.2 - Tightening torque for fine thread

<i>Nominal diameter</i>	<i>Tightening torque in N.M</i>		
	8.8	10.9	12.9
M 8*1	24 à 29	33 à 37	40 à 44
M 10*1.25	46 à 57	64 à 71	77 à 85
M 12*1.25	83 à 100	120 à 130	140 à 150
M 14*1.5	130 à 160	180 à 200	220 à 240
M 16*1.5	200 à 250	280 à 310	340 à 370
M 18*1.5	290 à 360	410 à 450	490 à 540
M 20*1.5	410 à 510	570 à 630	690 à 760
M 22*1.5	550 à 680	780 à 870	920 à 1000
M 24*1.5	690 à 860	970 à 1070	1160 à 1290
M 27*2	1000 à 1300	1400 à 1560	1690 à 1880
M 30*2	1400 à 1700	1960 à 2180	2350 à 2610

2.3.3 - Tightening torque for hydraulic hoses

<i>Description</i>	<i>Torque to apply (in lb.ft) mini - maxi</i>
2369068950 - Hose SP.1756(H)LG 0,620	18.5 - 25.81
2369069070 - Hose SP.1707(H)LG 2,080	7.4 - 11
2369069290 - Hose SP.5043 LG 0,770	44.3 - 7.4
2369069320 - Hose SP.5043 LG 1,510	44.3 - 59
2369069510 - Hose SP.1756 LG 0,420	18.4 - 25.8
2369069640 - Hose SP.1707 LG 1,510	7.5 - 11
2369069650 - Hose SP.1707 LG 1,640	7.5 - 11
2369069660 - Hose SP.1707 LG 2,150	7.5 - 11
2369070120 - Hose SP.5043 LG 2,610	44.3 - 59
2369070160 - Hose SP.5043 LG 1,110	44.3 - 59
2369070190 - Hose SP.5043 LG 0,970	44.3 - 59
2369070310 - Hose SP.1786 2,650m	18.5 - 25.81
2369070330 - Hose SP.1663 LG 2,380	29.5 - 36.8
2369070340 - Hose SP.1707 LG 6,700	7.5 - 11
2369070350 - Hose SP.1707 LG 21,40	7.5 - 11
2369070360 - Hose SP.1707 LG 7,100	7.5 - 11
2369070370 - Hose SP.1707 LG 18,40	7.5 - 11
2369070380 - Hose SP.1707 LG 18,20	7.5 - 11
2369070390 - Hose SP.1756 LG 6,50	18.5 - 25.81
2369070400 - Hose SP.5043 LG 1,010	44.3 - 59
2369070410 - Hose SP.5043 LG 1,170	44.3 - 59
2369070420 - Hose SP.5051 LG 1,570	154.8 - 177
2369070430 - Hose SP.1756 LG 2,620	18.5 - 25.81
2369070480 - Hose SP.1707 LG 0,750	7.5 - 11
2369070490 - Hose SP.1707 LG 1,350	7.5 - 11
2369070490 - Hose SP.1707 LG 1,350	7.5 - 11
2369070500 - Hose SP.1707 LG 2,250	7.5 - 11
2369070510 - Hose SP.1707 LG 2,900	7.5 - 11
2369070520 - Hose SP.1707 LG 2,950	7.5 - 11
2369070540 - Hose SP.1786 LG 2,900	18.5 - 25.81
2369070560 - Hose SP.5043 LG 1,210	44.3 - 59
2369070570 - Hose SP.5043 LG 2,430	44.3 - 59
2369070580 - Hose SP.5043 LG 2,470	44.3 - 59
2369070590 - Hose SP.5043 LG 2,710	44.3 - 59
2369070600 - Hose SP.5043 LG 3,410	44.3 - 59
2369070780 - Hose SP.1223 0,570m	29.5 - 50
2369071030 - Hose SP.1707 11,840m	7.5 - 11
2369071050 - Hose SP.1707 11,140m	7.5 - 11
2369071070 - Hose SP.5043 0,900m	44.3 - 59
2369071080 - Hose SP.1786 1,020m	18.5 - 25.81
2369071090 - Hose SP.5043 1,270m	44.3 - 59

2.3.4 - Pressure values (in bar)

- Pump:
 - Flow cancellation 240 bars
 - Load sensing (standby pressure) 30 bars

- PVG Danfoss distributor :
 - Entry pressure protection 270 bars
 - Rotation pressure limiter 100 bars

- Telescoping :
 - Output pressure 100 bars
 - Input chamber 160 bars
 - Large chamber braking valve 100 bars

- Boom lifting :
 - Lowering pressure 130 bars
 - Valve de freinage grande chambre 210 bars

- Arm lifting :
 - Lowering pressure 100 bars
 - Large chamber braking valve 210 bars

- Compensation :
 - Up/down braking valve 210 bars

- Jib:
 - Large chamber braking valve 210 bars

- Emergency unit: 130 bars

2.3.5 - Adjustment time

<i>Movement</i>	<i>Control</i>	<i>Movement duration</i>
Arm lifting	From the turntable	70 s +/- 4s
Arm lowering	From the turntable	70s +/- 4s
Boom lifting	From the turntable	40s +/- 3s
Boom lowering	From the turntable	30 s +/- 3s
Rotation left	From the turntable	60 s +/- 4s per 1/2 turn
Rotation right	From the turntable	60 s +/- 4s per 1/2 turn

<i>Movement</i>	<i>Control</i>	<i>Movement duration</i>	
		<i>HA20P</i>	<i>HA26P</i>
Arm lifting	From the basket	50s +/- 4s	60s +/- 4s
Arm lowering	From the basket	50s +/- 4s	60s +/- 4s
Boom lifting	From the basket	30s +/- 3s	40s +/- 3s
Boom lowering	From the basket	30s +/- 3s	
Rotation left	From the basket	52s +/- 4s per 1/2 turn	
Rotation right	From the basket	52s +/- 4s per 1/2 turn	
Micro micro speed travel forward	From the basket	80s +/- 2 / 10m	
Micro micro speed travel reverse	From the basket	80s +/- 2s / 10m	
Micro speed travel forward	From the basket	35s +/- 2s / 5m	
Micro speed travel reverse	From the basket	35s +/- 2s / 5m	
HS travel forward	From the basket	40s +/- 3s / 50m	
HS travel reverse	From the basket	40s +/- 3s / 50m	

3 - SAFETY SYSTEM

3.1 - FUNCTIONS OF THE TURRET CABINET FUSES AND RELAYS

(see chap. 4, page 25)

KA2	Heat engine starting
KP1	Heat engine stopping
KT2	Acceleration of movements (electromotor)
KMG	Mains supply
KM4	Electropump contactor
FU1-10 A	Engine stop circuit fuse
FU3-80 A	Accelerator circuit fuse
FU4-30 A	General circuit fuse
FU5-3 A	Fuse for circuit for controlling movements from turret
FU6-3 A	Fuse for circuit for controlling movements from platform
FU7-20 A	Solenoid valve supply circuit fuse
FU8-5 A	Turret/platform control circuit fuse
FU9-20 A	Accessories circuit fuse
FU10-3 A	Circuit fuse
FU11-250 A	Engine circuit fuse

3.2 - FUNCTION OF THE SAFETY SWITCHES

(see chap. 4, page 25)

SB1	Mushroom-headed emergency stop button (turret)
SB2	Mushroom-headed emergency stop button (platform)
SQ1	Tilt unit, prohibits by a cut, the arm lifting, boom raising, telescoping, pendular raising and travel movements
SQ4	Tilt reset, if machine folded (arm)
SQ5	Overload 1st audible alarm. Threshold of 90% of maximum charge reached
SQ6	Overload 2nd alarm - Cut-out. Cuts all the movements on platform except basket rotation
B1	Air filter switch: Engine cut-out if air filter clogged
B2	Engine temperature switch: Engine cut-out if temperature too high
B3	Engine oil pressure switch: Engine cut-out if pressure insufficient
B4	Hydraulic oil temperature switch: audible warning if temperature too high

4 - WIRING DIAGRAM

4.1 - WIRING DIAGRAM E 448 - FOLIO 01/05

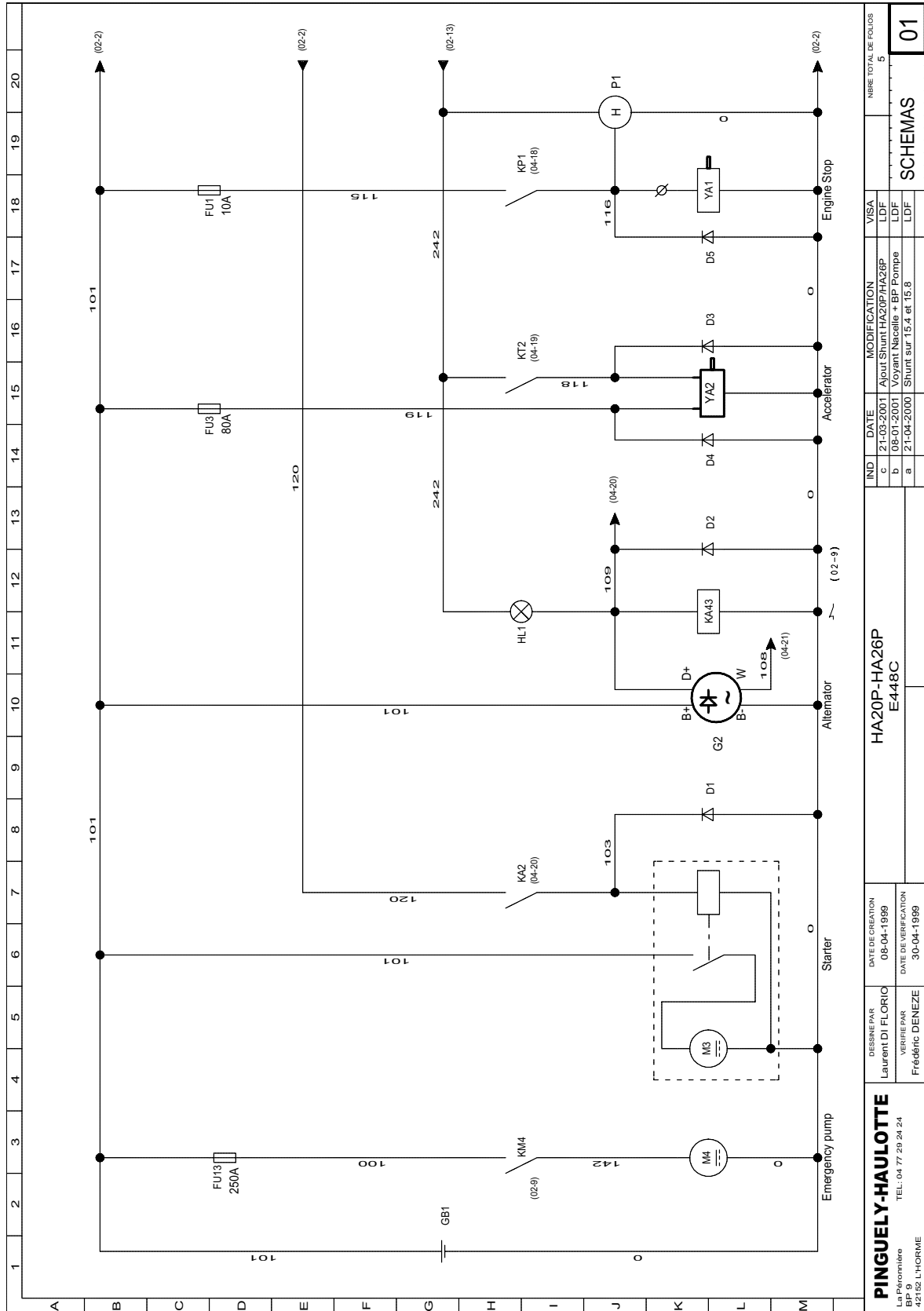

4.2 - WIRING DIAGRAM E 448 - FOLIO 02/05

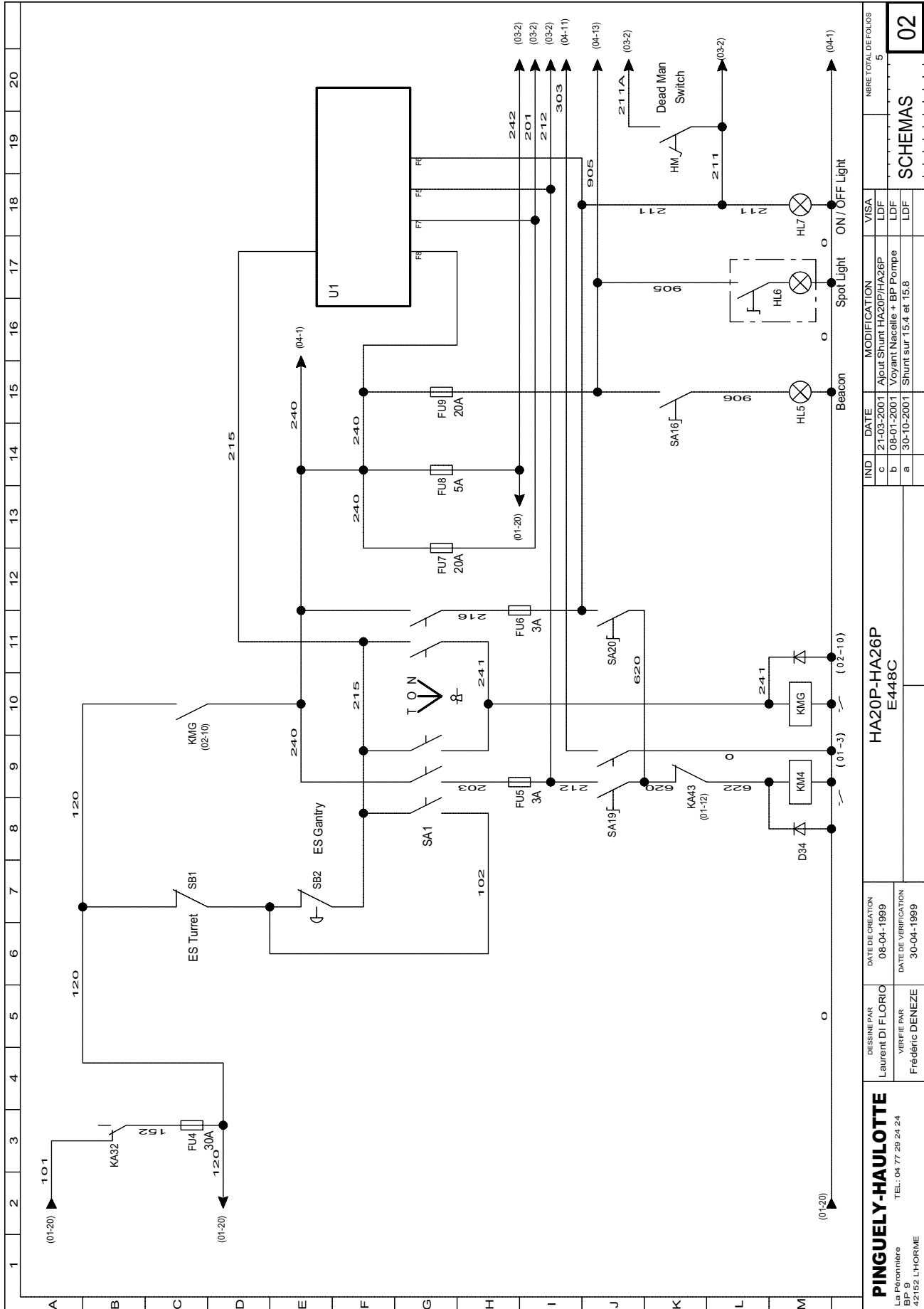

PINGUELY-HAULOTTE La Péronnière BP 9 42152 L'HORME		DATE DE CREATION 08-04-1999		DATE DE VERIFICATION 30-04-1999		HA20P-HA26P E448C		IND		DATE		MODIFICATION		VISA		NRE TOTAL DE FOLIOS	
		Laurent DI FLORIO		Frédéric DENEZE				c		21-03-2001		Ajout Shunt HA20P/HA26P		LDF		5	
								b		05-01-2001		Ajout Nacelle + BP Pompe		LDF			
								a		30-10-2001		Shunt sur 15.4 et 15.8		LDF			
SCHEMAS																02	

4.3 - WIRING DIAGRAM E 448 - FOLIO 03/05

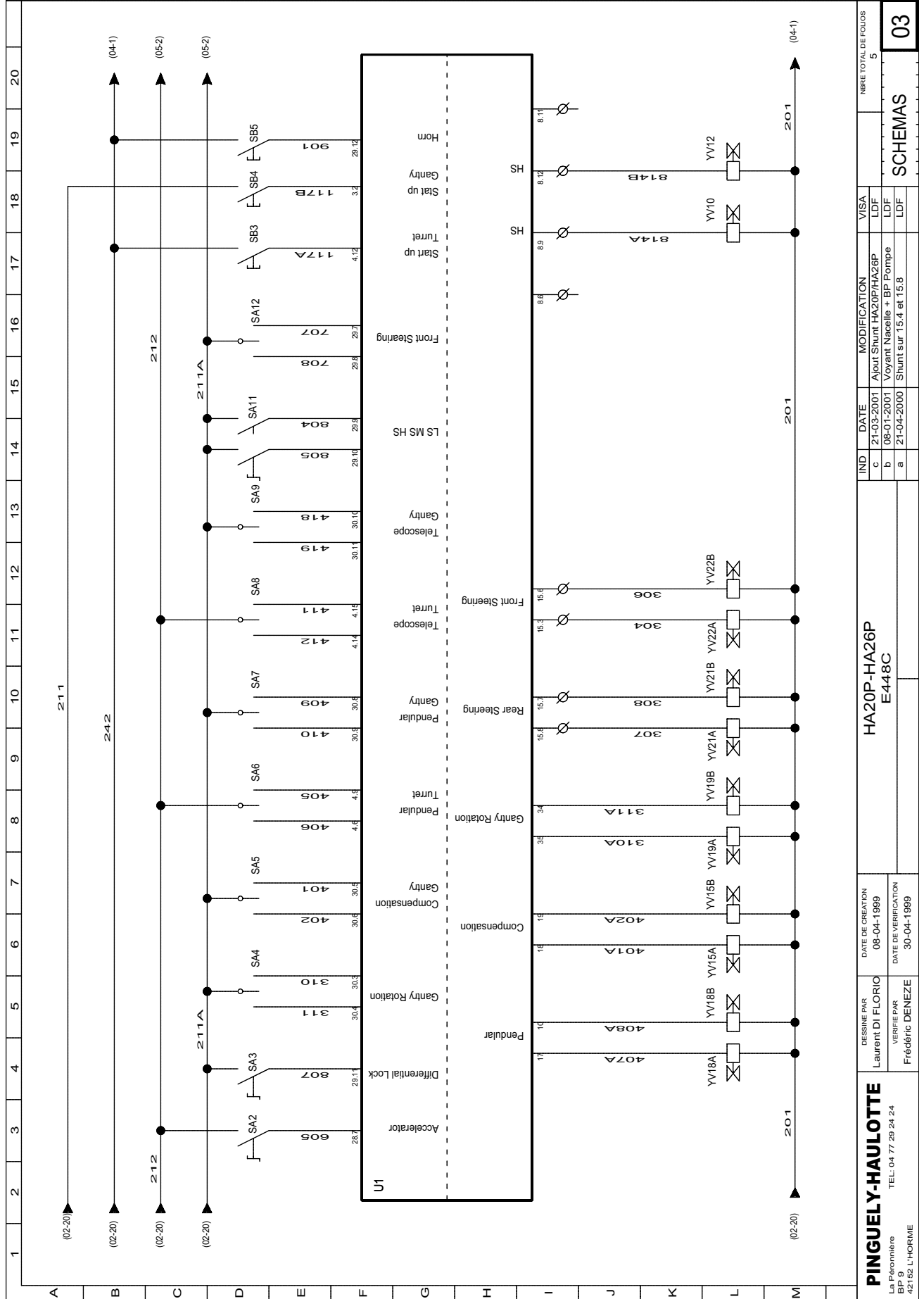

4.4 - WIRING DIAGRAM E 448 - FOLIO 04/05

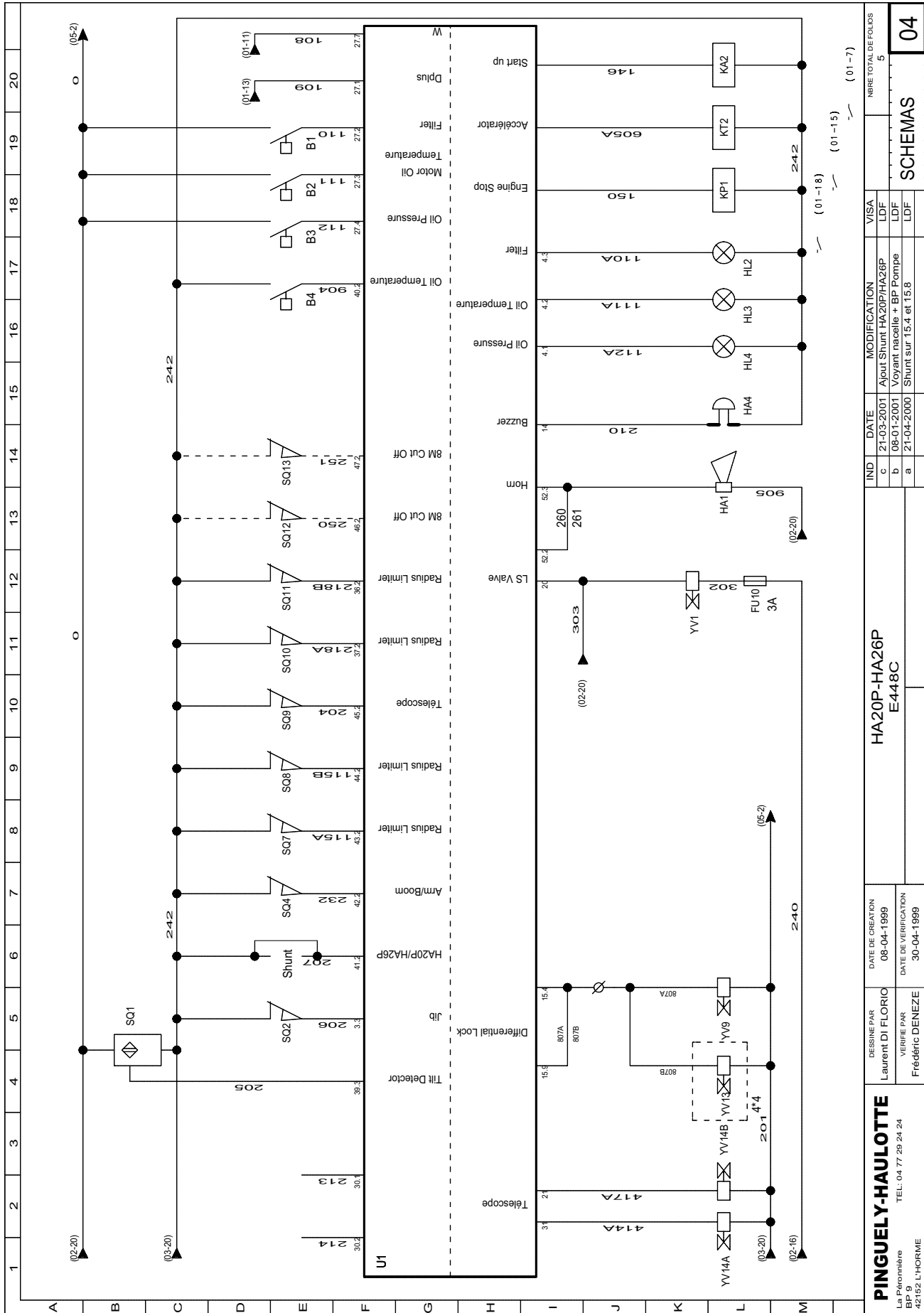

PINGUELY-HAULOTTE La Péronnière BP 9 42152 L'HORME		DRESSINE PAR Laurent DI FLORIO		DATE DE CREATION 08-04-1999		HA20P-HA26P E448C		IND c b a		DATE 21-03-2001 08-01-2001 21-04-2000		MODIFICATION Ajout Shunt HA20P/HA26P Voyant nacelle + BP Pompe Shunt sur 15.4 et 15.8		VISA LDF LDF LDF		INBRE TOTAL DE FOLIOS 5	
SCHEMAS														04			

4.5 - WIRING DIAGRAM E 448 - FOLIO 05/05

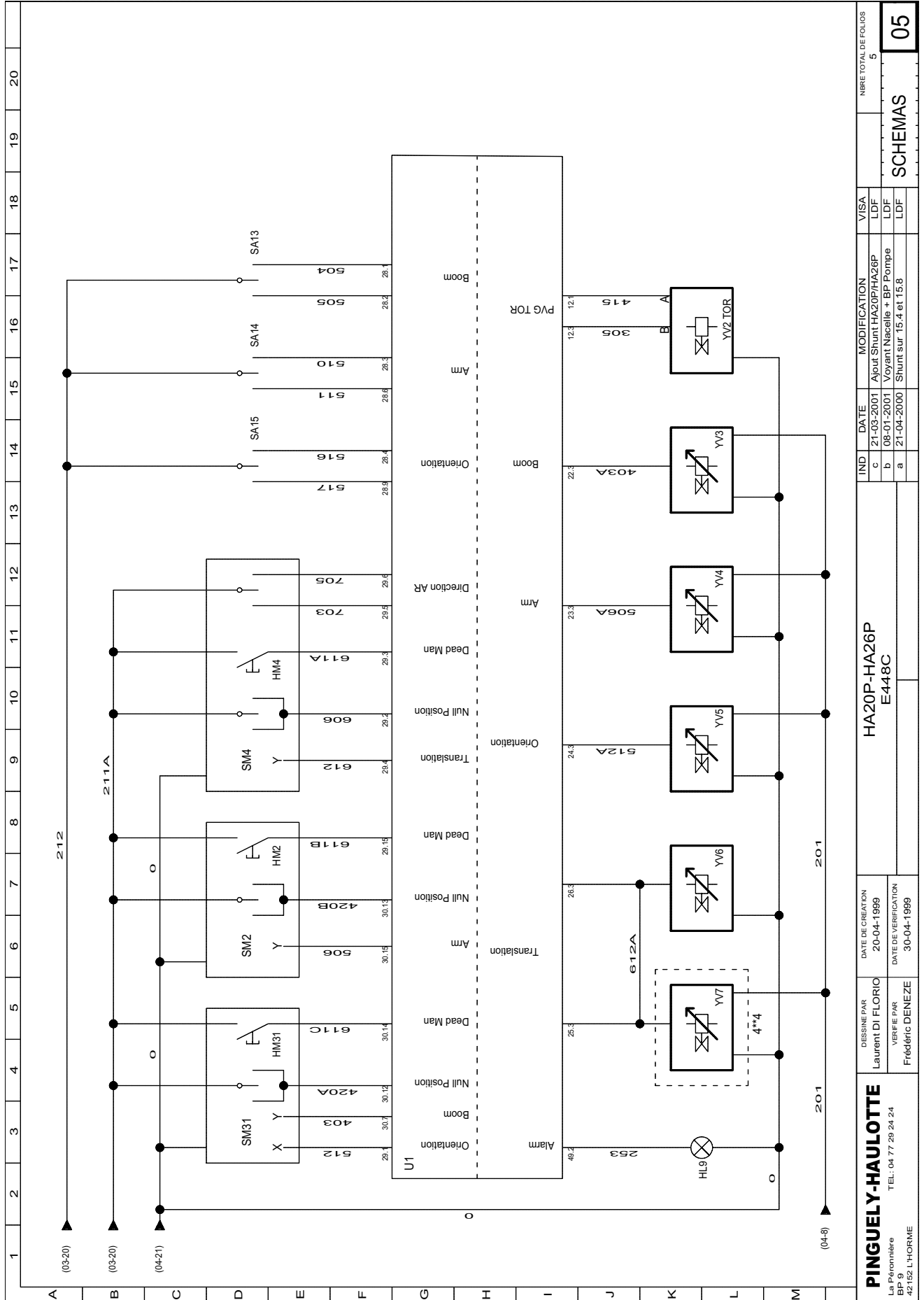

PINGUELY-HAULOTTE La Péronnière BP 9 42152 L'HORME		DISSINÉ PAR Laurent DI FLORIO	DATE DE CREATION 20-04-1999	HA20P-HA26P E448C		IND	DATE	MODIFICATION	VISA	NOMBRE TOTAL DE FOLIOS 5	
		VERIFIÉ PAR Frédéric DENEZE	DATE DE VERIFICATION 30-04-1999			c	21-03-2001	Ajout Shunt HA20P/HA26P	LDf		
						b	08-01-2001	Voyant Nacelle + BP Pompe	LDf		
						a	21-04-2000	Shunt sur 15.4 et 15.8	LDf		
										SCHEMAS	
										05	

4.6 - PART LIST

ITEM	FOLIO-COL	DESIGNATION
SB1	02 -7	Mushroom-headed button
SB2	02 -7	Mushroom-headed button
SB3	03 -17	Turret starting switch
SB4	03 -18	Platform starting switch
SB5	03 -19	Warning switch
SA1	02 -10	Post selection key switch
SA2	03 -2	Accelerator switch
SA3	03 -3	Differential lock switch
SA4	03 -5	Platform rotation switch
SA5	03 -6	Platform compensation switch
SA6	03 -8	Turret pendular switch
SA7	03 -9	Platform pendular switch
SA8	03 -11	Turret telescoping switch
SA9	03 -12	Platform telescoping switch
SA11	03 -14	Low/medium/high speed switch
SA12	03 -15	Forward direction switch
SA13	05 -17	Turret raising switch
SA14	05 -15	Turret lifting switch
SA15	05 -14	Turret slewing switch
HL1	01 -12	Battery charging light
HL2	04 -17	Air filter light
HL3	04 -16	Oil temperature light
HL4	04 -16	Oil pressure light
HL7	02 -18	Power light
SM31	05 -4	Boom raising/slewing control
SM2	05 -6	Arm lifting controller
SM4	05 -10	Travel/direction controller
SQ1	04 -4	Tilt detector
SQ2	04 -5	Pendular position switch
SQ4	04 -7	Arm/boom position switch
SQ5	04 -2	Threshold 1 weighing position switch
SQ6	04 -1	Threshold 2 weighing position switch
SQ9	04 -10	Telescoping position switch
KMG	02 -10	General relay
KP1	04 -18	Engine stop relay
KT2	04 -19	Accelerator relay
KA2	04 -20	Starter relay
FU1	01 -18	Engine stop circuit fuse
FU3	01 -15	Accelerator circuit fuse
FU4	02 -3	General circuit fuse
FU5	02 -9	Turret movements control circuit fuse
FU6	02 -11	Platform movements control circuit fuse
FU7	02 -12	Solenoid valves supply circuit fuse
FU8	02 -14	Turret/platform common circuit fuse
FU9	02 -15	Accessories circuit fuse
FU10	04 -12	YV1 circuit fuse
FU11	01 -3	SOS M4 engine circuit fuse
U1	02/03/04/05	
YV1	04 -12	Load Sensing solenoid valve
YV2	05 -16	On/off control selection solenoid valve
YV3	05 -14	Boom raising control solenoid valve
YV4	05 -11	Arm lifting control solenoid valve
YV5	05 -9	Slewing control solenoid valve

ITEM	FOLIO-COL	DESIGNATION
YV6	05 -7	4x2 travel control solenoid valve
YV9	04 -6	4x2 differential lock control solenoid valve
YV14	04 -2	Telescoping control solenoid valve
YV15	03 -6	Compensation control solenoid valve
YV18	03 -4	Pendular control solenoid valve
YV19	03 -7	Platform rotation control solenoid valve
P1	01 -19	Hour counter
HA1	04 -14	Horn
HA2	04 -3	Weighing buzzer
HA4	04 -14	Tilt warning
YV7	05 -5	Travel control solenoid valve
YV10	03 -17	Travel speeds combination solenoid valve
YV12	03 -18	Travel speeds combination solenoid valve
YV13	04 -4	Differential lock control solenoid valve
YV21	03 -10	FORWARD direction control solenoid valve
YV22	03 -11	REVERSE direction control solenoid valve
KM4	01 -3	M4 electropump contactor
SQ7	04 -8	Engine cut-out position switch
SQ8	04 -9	Engine cut-out position switch
SQ10	04 -11	Movement cut-out position switch
SQ11	04 -12	Movement cut-out position switch
B1	04 -19	Air filter pressure controller
B2	04 -18	Engine oil temperature pressure controller
B3	04 -18	Engine oil pressure controller
B4	04 -17	Hydraulic oil temperature pressure controller
B6	04 -16	Gas pressure controller (option)
		BEACON OPTION
HL5	02 -15	Beacon
SA16	02 -15	Single-pole switch
		8 m CUT-OUT OPTION
SQ12	04 -13	8 m cut-out position switch
SQ13	04 -14	8 m cut-out position switch
SQ3	04 -6	Shunt travel 26 m (tilt 3°)
HL9	05 -2	Fault light indicator

5 - MACHINES ELEMENTS

5.1 - MOTOR

G2	Generator
M3	Motor start
YA2	Accelerator
YA1	Motor stop
U1	Frequency module

5.2 - FUSES

FU1	10A Motor stop
FU3	80A Maintain accelerator
FU4	30A + Main
FU5	3A 212 + turntable
FU6	3A 211 +Platform
FU7	20A 201 + if an electrovlve is supplied permanently, FU7 is destroyed
FU8	5A 242 +Permanent
FU9	20A +Accessories
FU10	3A Load Sensing valve

5.3 - INPUT

5.3.1 - Control inputs :

SB3	Turntable start 117A
SB4	Platform start 117B
SB5	Buzzer 901
SA2	Accelerator 605
SA3	Differential blocking 807
SA4	Platform basket rotation
	SA4a : right 311
	SA4b : left310
SA5	Platform compensation
	SA5a : up 401
	SA5b : down 402
SA6	Turntable jib
	SA6a : down 405
	SA6b : up 406
SA7	Platform jib
	SA7a : down 409
	SA7b : up 410
SA8	Turntable telescope
	SA8a :input 411
	SA8b : output 412
SA9	Platform telescope
	SA9a : input 418
	SA9b : output 419

- SA11 Speed selection
 - LS : 805=1 804=0
 - MS :805=0 804=0
 - HS : 805=0 804=1
- SA12 Front steering
 - SA12a : left708
 - SA12b : right 707
- SA13 Turntable liftig
 - SA13a : up 504
 - SA13b :down 505
- SA14 Turntable lifting
 - SA14a : up 510
 - SA14b : down 511
- SA15 Turntable rotation
 - SA15a :left 516
 - SA15b :right 517
- SA17 Platform electrical/thermal
 - SA17a :thermic 917
 - SA17b :electric 918
- SA18 Turntable electrical/thermal
 - SA18a :thermic 919
 - SA18b :electric 920
- SM31 Steering and lifting
 - Consign X Rotation 512
 - Consign Y Lifting 403
 - Up : from 2,5 to 4,5v
 - Down : from 2,5 to 0,5v
 - HM31 : Fail-safe 611B
 - SM31ab :Except neutral 420B
- SM2 Lifting
 - Consign Y lifting 506
 - Up : from 2,5 to 4,5v
 - Down : from 2,5 to 0,5v
 - HM2 : Fail-safe 611B
 - SM2ab : Except neutral 420B
- SM4 Travel
 - Consign Y Travel 612
 - Forward : from 2,5 to 4,5v
 - Reverse : from 2,5 to 0,5v
 - HM4 : Fail safe 611A
 - SM4ab : Except neutral 606
- Rear steering
 - SM4c : left 703
 - SM4d : right 705

5.3.2 - Safety inputs :

SQ1	Tilt (205=0v if " in slope ")
SQ2	Jib from 0 to 90°(206=0 if with the top of 0°)
SQ4	Separated boom or arm (207=0 if " Separated boom or arm ")
SQ5	1st step loading (213=12v if "overload")
SQ6	2nd step loading (214=0v if "overload")
SQ7	Outreach limitation cut on engine on telescope
SQ8	Outreach limitation cut on engine on boom
SQ9	Telescope out (204=0 if telescope in)
SQ10	Outreach limitation. Telescope extraction cut out
SQ11	Outreach limitation. Boom lowering cut out
SQ12	8M stopped (250=0v if boom > 45°)
SQ12	8M stopped : option (250=0v if boom > 45°)
B1	Filter clogged (110=0v if filter clogged)
B2	Engine oil temperature (111=0v if temperature >80°C)
B3	Engine oil pressure (112=0v if pressure > 0,5b)
B4	Oil tank temperature (904=0v if temperature > 130°C)
D+	Alternator (109=12v If the alternator work)
W	Anti-starter (108=12v When the engine is on)

5.4 - OUTPUT**5.4.1 - Relay**

KP1	Motor stop
KT2	Accelerator
KA2	Starter

5.4.2 - "On/Off" electrovalves

12v =	électro commandée / 0v = électro non commandée
YV1	Load Sensing 303, time delayed for 2 seconds
YV2a	Telescope 305
YV2b	Steerinf, rotation, compensation, jib 415
YV9	Differential blocking 807A
YV10	High speed 814B
YV12	High speed 814A
YV13	Differential blocking 807B
YV14a	Telescope in 414A
YV14b	Telescope out 417A
YV15a	Compensation up 401A
YV15b	Compensation down 402A
YV18a	Jib down 407A
YV18b	Jib up 408A
YV19a	Basket rotation left 310A
YV19b	Basket rotation right 311A
YV21a	Rear left steering in 4*4 307
YV21b	Rear right steering in 4*4 308
YV22a	Front right steering in 4*4 304
YV22b	Front left steering in 4*4 306

5.4.3 - Proportional electrovalves

The supply voltage of proportional electrovalves varies from 6 to 3V in one direction and 6 to 6V in the other.

YV3	Lifting 403A
YV4	Telescoping 506A
YV5	Rotation 512A
YV6	Travel 612A
YV7	Travel 612A

5.4.4 - Buzzer and light indicators

HA1	Horn 260-261
HA2	Overload 1st threshold buzzer 213
HA4	Tilt, overload, temperature buzzer 210
HL1	Battery charge 109
HL2	Air filter 110A
HL3	Motor oil temperature 111A
HL4	Motor oil pressure 112A

6 - OPERATING EQUATIONS

The lights inside the panel show the solenoid valve's conditions :

Light off : solenoid valve present but not activated

Weak light : solenoid valve not connected

Strong light : solenoid valve present and activated

Machine folded: SQ2=1 and SQ4=1 and SQ9=1

Machine unfolded : SQ2=0 ou SQ4=0 ou SQ9=0

6.1 - START

if (SB3=1 or SB4=1) and W=0 and D+=0 and YV1 pas alimentée then KA2=1

6.2 - STOP MOTEUR

if KA2=1 or (No motor fault for more than 6 seconds)* then KP1=1

*No motor fault => D+=1 and B2=1 and B3=1

6.3 - ACCELERATOR

if (HM4=1 or HM31=1 or HM2=1 or SA9a=1 or SA9b=1) and SQ6=1 or SA2=1 then KT2=1

Accelerator is time delayed for 0.5 seconds.

6.4 - COMPENSATION

Up

if SA5a=1 and SQ6=1 and SA9a=0 and SA9b=0 and SM31ab=0 and SM2ab=0 then YV15a=1 and YV2b=1 and YV1=1

Down

if SA5b=1 and SQ6=1 and SA9a=0 and SA9b=0 and SM1ab=0 and SM2ab=0 then YV15b=1 and YV2b=1 and YV1=1

6.5 - ROTATION

Right

if SA4a=1 then YV19b=1 and YV2b=1 and YV1=1

Left

if SA4b=1 then YV19a=1 and YV2b=1 and YV1=1

6.6 - JIB

Up

if (SA6b=1 or SA7b=1) and (SQ1=1 or machine folded) and (SQ6=1 or turntable position)

then YV18b=1 and YV2b=1 and YV1=1

Down

if (SA6a=1 or SA7a=1) and (SQ6=1 or Turntable position)

then YV18a=1 and YV2b=1 and YV1=1

6.7 - ROTATION

Turntable

Left

if SA15a=1 then YV1=1 and YV5=1

Right

if SA15b=1 then YV1=1 and YV5=1

Platform

Left

if HM31=1 and SM31ab=0 puis SM31ab=1 and SQ6=1 and then YV1=1 and YV5=1

Right

if HM31=1 and SM31ab=0 puis SM31ab=1 and SQ6=1 and then YV1=1 and YV5=1

6.8 - ARM LIFTING

Turntable

Up

if SA14a=1 and (SQ1=1 or machine folded) then YV1=1 and YV4=1

Down

if SA14b=1 then YV1=1 and YV4=1 (if SQ4=1 then the end of the lowering movement is slowed down)

Platform

Up

if HM2=1 and SM2ab=0 puis SM2ab=1 and SQ6=1 and (SQ1=1 or machine folded) then YV1=1 and YV4=1

Down

if HM2=1 and SM2ab=0 puis SM2ab=1 and SQ6=1 then YV1=1 and YV4=1

6.9 - BOOM LIFTING**Turntable****Up**

if SA13a=1 and (SQ1=1 or machine folded or SQ9=1) then YV1=1 and YV3=1

Down

if SA13b=1 and (SQ1=1 or machine folded or SQ9=1) then YV1=1 and YV3=1

Turntable**Up**

if HM31=1 and SM1ab=0 then SM1ab=1 and SQ6=1 and (SQ1=1 or machine folded or SQ9=1) then YV1=1 and YV3=1

Down

if HM31=1 and SM1ab=0 puis SM1ab=1 and SQ6=1 and (SQ1=1 or machine folded or SQ9=1) then YV1=1 and YV3=1

6.10 - TELESCOPING**Input**

if (SA8a=1 or SA9a=1) and (SQ6=1 or turntable position) then YV14a=1 and YV2a=1 and YV1=1

Output

if (SA8b=1 or SA9b=1) and (SQ1=1 or machine folded) and (SQ6=1 or turntable position)

then YV14b=1 and YV2a=1 and YV1=1

6.11 - TRAVEL

if unfolded machine then micro speed = 1

if machine folded then micro speed = 0

if SA11a=0 and SA11b=1 and MicroSpeed =0 then LowSpeed=1∩YV1=1

if SA11a=1 and SA11b=0 and MicroSpeed =0 then High Speed=1∩YV1=1 and YV12=1 and YV10=1

if HM4=1 et SM4ab=0 puis SM4ab=1 and (SQ1=1 or machine folded) and SA9a=0 and SA9b=0 and SM31ab=0 and SM2ab=0 then YV6=1 and YV7=1

Low Speed, High Speed: Full setpoint

Micro Speed: Low setpoint

8M cut out

if SQ12=0 or (SQ4=0 and SQ3=0) then cut of travel

6.12 - STEERING

When the machine is off and in slope, both axles can not used at the same time.

When the machine is driving mode and in slope position, both axles can be used at the same time.

Front axle**Left**

if SA12a=1 and SQ6=1 and (SM4ab=1 or SQ1=1 or (SM4c=0 and SM4d=0))

then YV22a=1 and YV2b=1 and YV1=1

Right

if SA12b=1 and SQ6=1 and (SM4ab=1 or SQ1=1 or (SM4c=0 and SM4d=0))
then YV22b=1 and YV2b=1 and YV1=1

Rear axle

Left

if SM4c=1 and SQ6=1 then YV21a=1 and YV2b=1 and YV1=1

Right

if SM4d=1 and SQ6=1 then YV21b=1 and YV2b=1 and YV1=1

6.13 - DIFFERENTIAL BLOCKING

if SA3=1 and SA11a=0 and MicroSpeed=0 then YV9=1 and YV13=1

6.14 - HORN - BUZZER

if SB5=1 then HA1=1

if SQ1=0 and machine unfolded then the buzzer sounds continuously.

if B4=0 then the buzzer sounds with a frequency F1.

if SQ6=0 and turntable position then the buzzer HA4 (platform) sounds with a frequency F1.

if travel_Buzzer_option=1 and HM4=1 then the buzzer sounds with a frequency F2.

if SQ5=1 then the buzzer HA2 (platform) sounds continuously

6.15 - INDICATORS

if B1=0 then HL2=1

if B2=0 then HL3=1

if B3=0 then HL4=1

6.16 - OTHER FUNCTIONS : OVERLOAD, DEAD MAN, SLOPE

6.16.1 -Overload

Overload through SQ6 cuts out all the movements controlled from the basket. When you switch to turntable position, the movements are slower. Moreover, the turntable buzzer sounds.

If SQ6 gets to 0 during a movement controlled from the basket, the latter is not cut out.

If SQ. gest to 0 during a movement controlled from the turntable, the latter is slowed down.

6.16.2 -Dead man

During the movement, dead man pedals can be released for 0.5 seconds.

If the dead man is actuated for x seconds (joystick neutral), the movement can not be actuated.

Travel : x = 6s

Movements : x = 4s

6.16.3 -Slope

When the machine is unfold ans in slope position, boom lifting, jib lifting and travel cut out. The buzzer sounds continuously.

6.17 - HA26P REACH LIMIT

Refer to working area diagram

A area : no cut out

B area : slower movements

C area : telescope extraction cut out

D area : boom lowering cut out

E area : telescope extraction cut out

F area : engine cut out

7 - SAFETY LOCATION

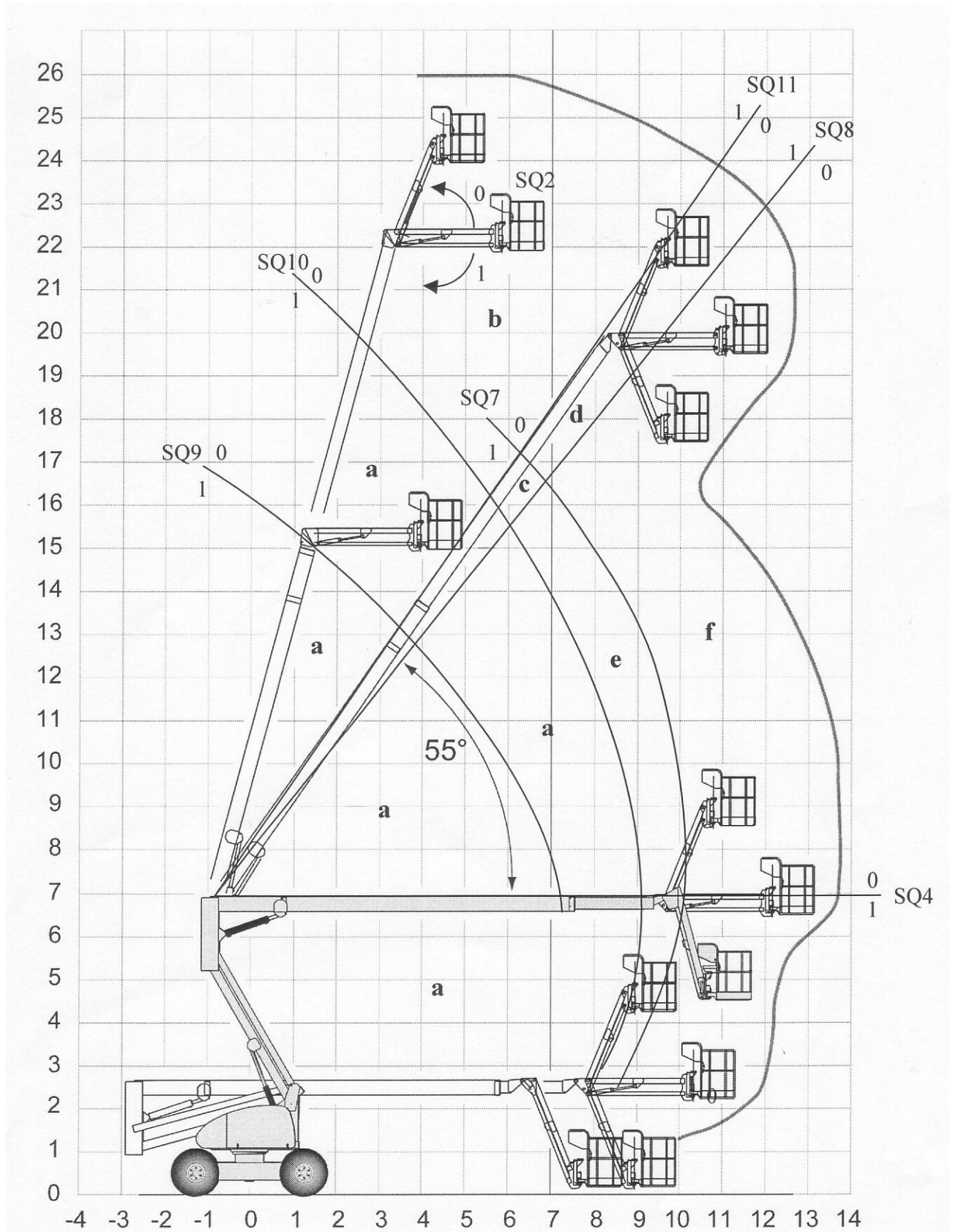

8 - POSITIONS OF ELECTRIC COMPONENTS

8.1 - MOTHER BOARD

8.1.1 - Description

Ref	SCREW		Ref	Connector	
1	101	+ Battery	28	1	Flashing light
2	105	+ Bi-energy machine - option	29	2	Bottom box door
3	120	+ Main	30	3	Top control panel
4	103	Starter	31	4	Bottom box door
5	118	Accelerator control	32	55	KMG main relay
6	240	Main supply after switch	33	5	KM4 standby pump switch
7	102	Emergency stop circuit	34	6	Console connector
8	215	Emergency stop circuit	35	52	HA1 horn
9	0	- Battery	36	7	Gas electrovalves option
10	226	Petrol gas machine - option	37	54	Proportional valve output
11	224	Petrol gas machine - option	38	14	Buzzer
		RELAYS	39	47	SQ13
12	KA2	Start	40	22	Boom lifting PVG
13	KP1	Motor stop	41	23	Telescoping or arm lifting PVG
14	KA32	Electric power / thermal power switch	42	24	Rotation PVG
15	KT2	Accelerator	43	25	Travel PVG
16	KA43	Standby pump safety system	44	26	Travel PVG
17	KA37	Converter for bi-energy machine	45	27	Motor wiring harness
18	KA46	Petrol / gas switch	46	28	Top control panel
		FUSES	47	29	Top control panel
19	F1	Motor stop	48	30	Top control panel
20	F3	Maintain accelerator	49	36	SQ11
21	F4	Main	50	37	SQ10
22	F5	+ Bottom position	51	39	SQ6 Tilt
23	F6	+ Top position	52	40	Hydraulic tank temperature probe B4
24	F7	+ Electrovalve	53	41	SQ3
25	F8	+ Permanent (sensor supply)	54	42	SQ4 or SQ14
26	F9	+ Accessories	55	43	SQ7
27	F10	+ Load Sensing valve for machine with PVG	56	44	SQ8
			57	45	SQ9

8.1.2 - Positions of screws, connectors and relays

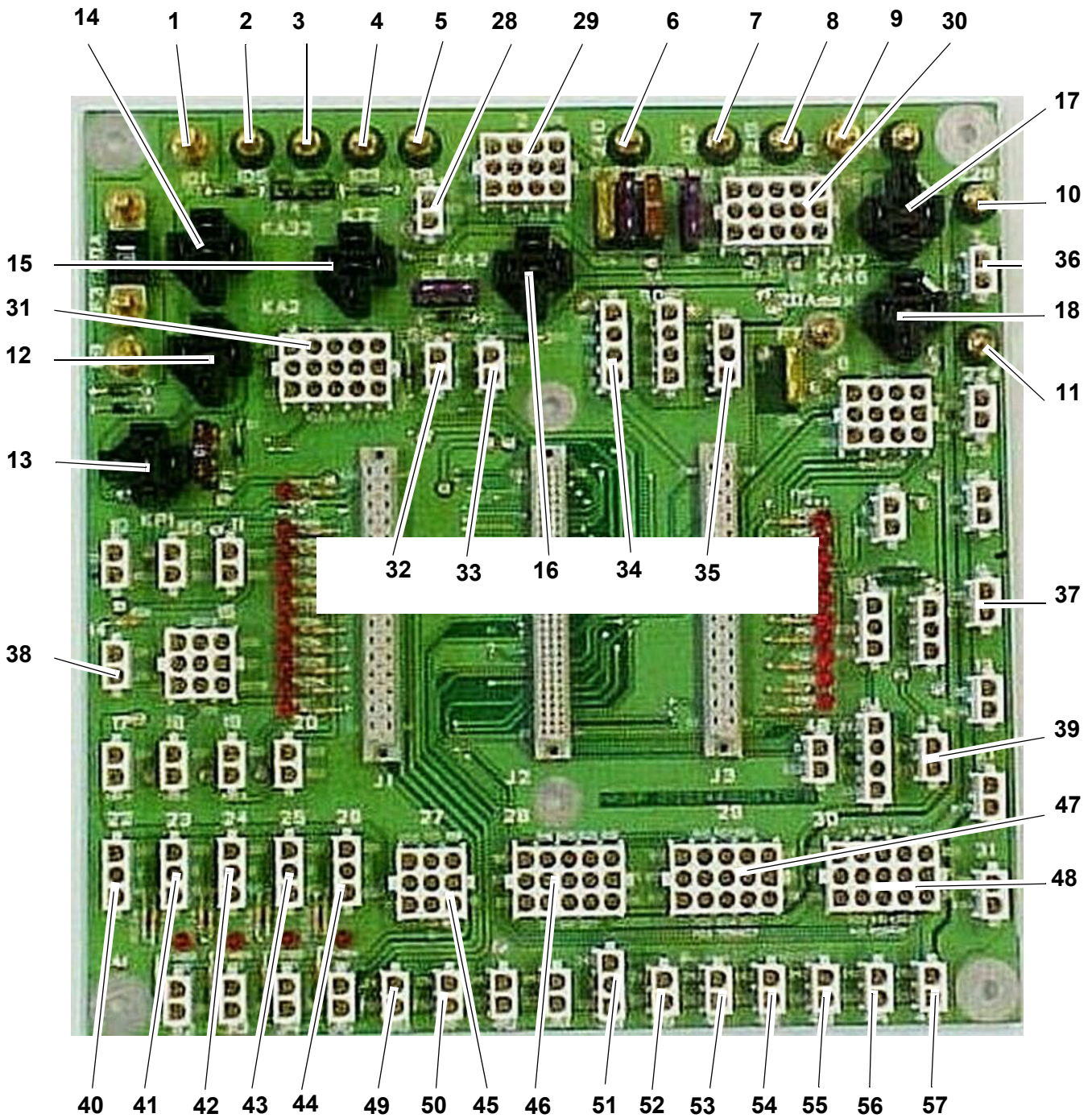

8.1.3 - Positions of fuses

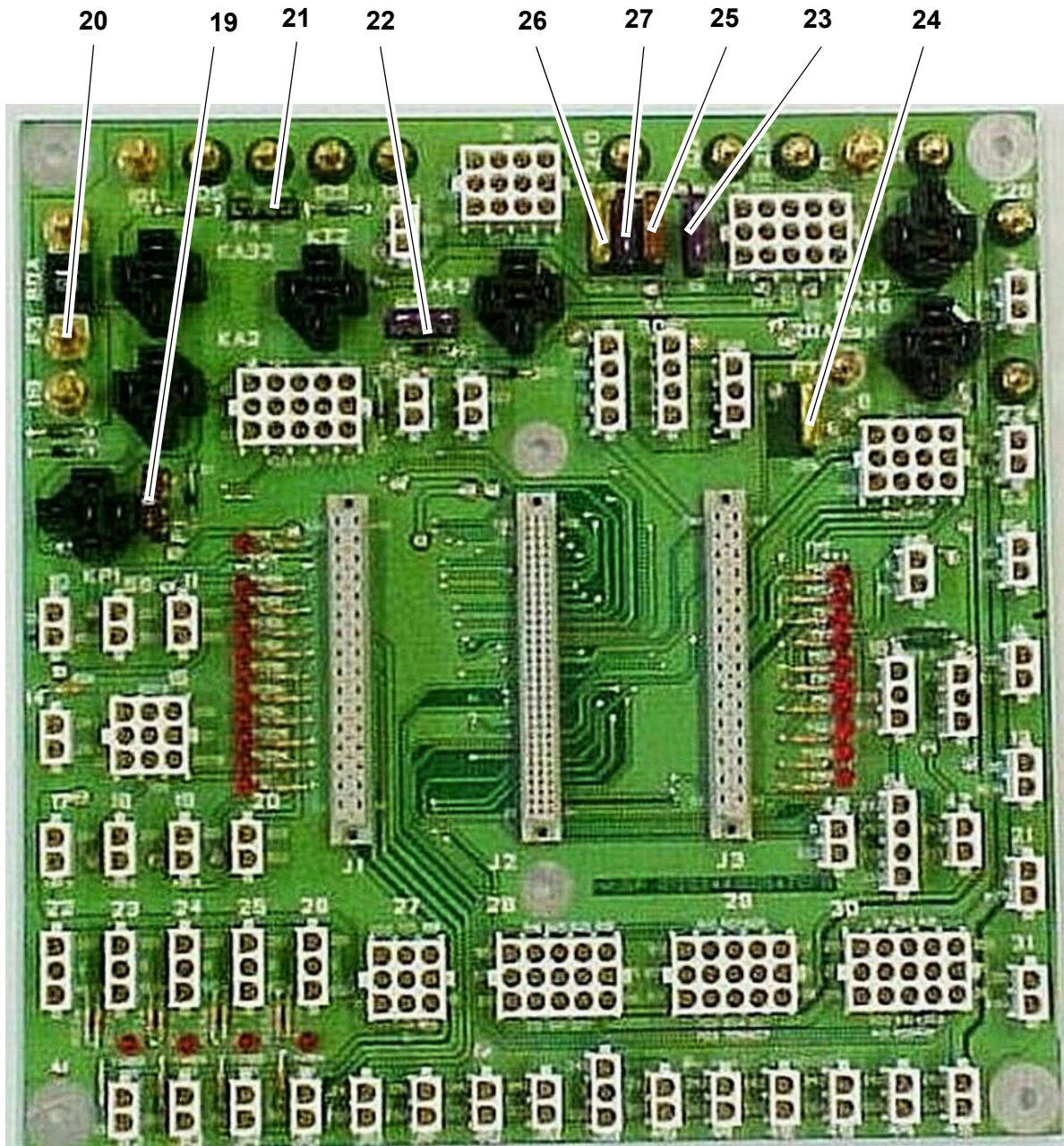

8.1.4 - Positions of diagnosis help LEDs

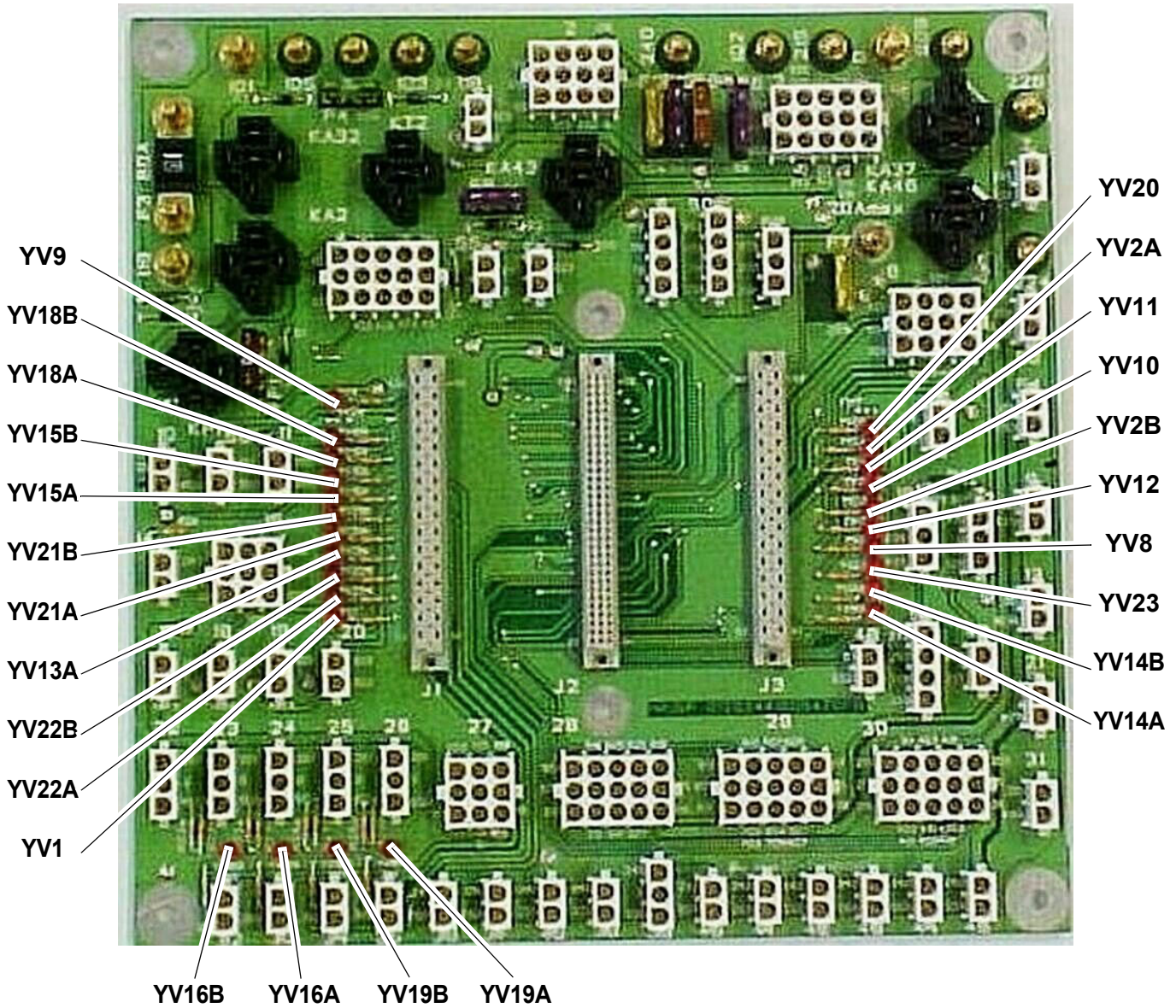

9 - HYDRAULIC DIAGRAMS

9.1 - HYDRAULIC DIAGRAM FOR HA20/26PX AND HA61/80JRT MODELS (B1539)0

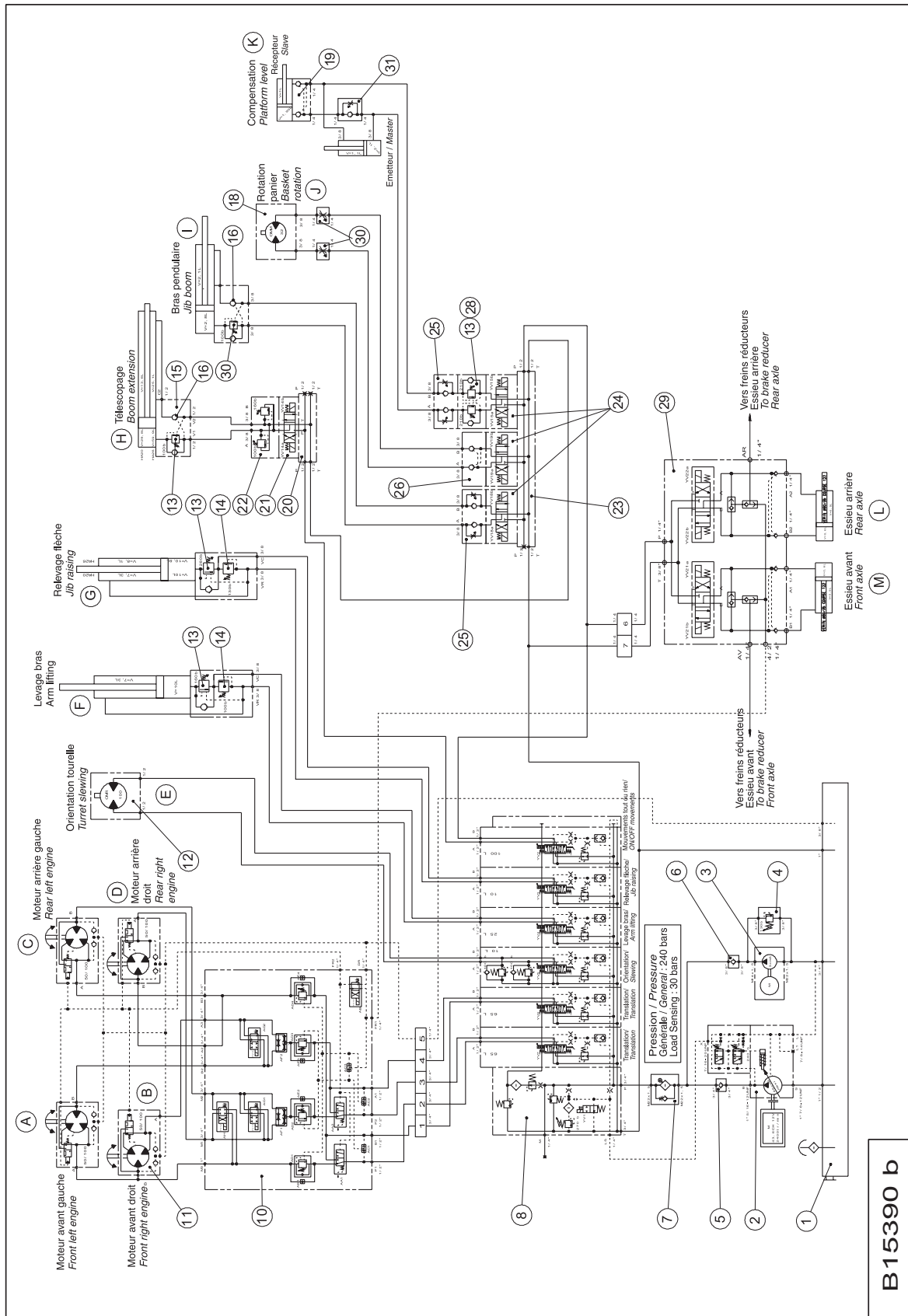

DESCRIPTION B15390

REF	DESCRIPTION
A	Left front engine
B	Right front engine
C	Left rear engine
D	Right rear engine
E	Turret slewing
F	Arm lifting
G	Boom raising
H	Telescoping
I	Pendular arm
J	Platform rotation
K	Compensation
L	Front axle
M	Rear axle
N	Travel
O	On/off movement
1	Hydraulic reservoir unit
2	LS piston pump, max. 45cm ³ /rev.
3	1500W, 3cm ³ , 12V electric pump unit
4	3/8 " BSPP in line pressure limiter
5	3/4 " BSPP non-return valve, 0.5 bar
6	3/8 " BSPP non-return valve, 0.5 bar
7	Pressure filter + clogging indicator
8	PVG32 12V S5086 distribution block
10	4x4 12V S5095 travel block
11	Double-displacement hydraulic motor
12	Hydraulic motor
13	Cartridge balancing valve, r=3:1
14	Cartridge pressure limiter
15	S5136 telescoping block
16	Cartridge non-return valve
18	Hydraulic motor
19	Flanged piloted double non-return valve
20	CETOP5 base plate, 1 section
21	12V NG10 4/3 AB towards T solenoid valve
22	CETOP5 double pressure limiter
23	CETOP3 base plate, 3 sections
24	12V NG6 4/3 AB towards T solenoid valve
25	CETOP3 double (pressure) flow limiter
26	CETOP3 piloted double non-return valve
28	CETOP3 body, 2 T11 housings
29	12V S5054 steering/brake release block

10 - HYDRAULICS COMPONENTS DESCRIPTION

10.1 - TRAVEL BLOCK

10.1.1 -Location

Ref	Description
2	YV12 - high speed solenoid valve
3	AF1 - flow divider
4	YV13 - differential lock solenoid valve
5	AF2 - flow divider
6	YV9
7	YV10 - High speed solenoid valve, supply and control of 2 control valves AA1 and AA2

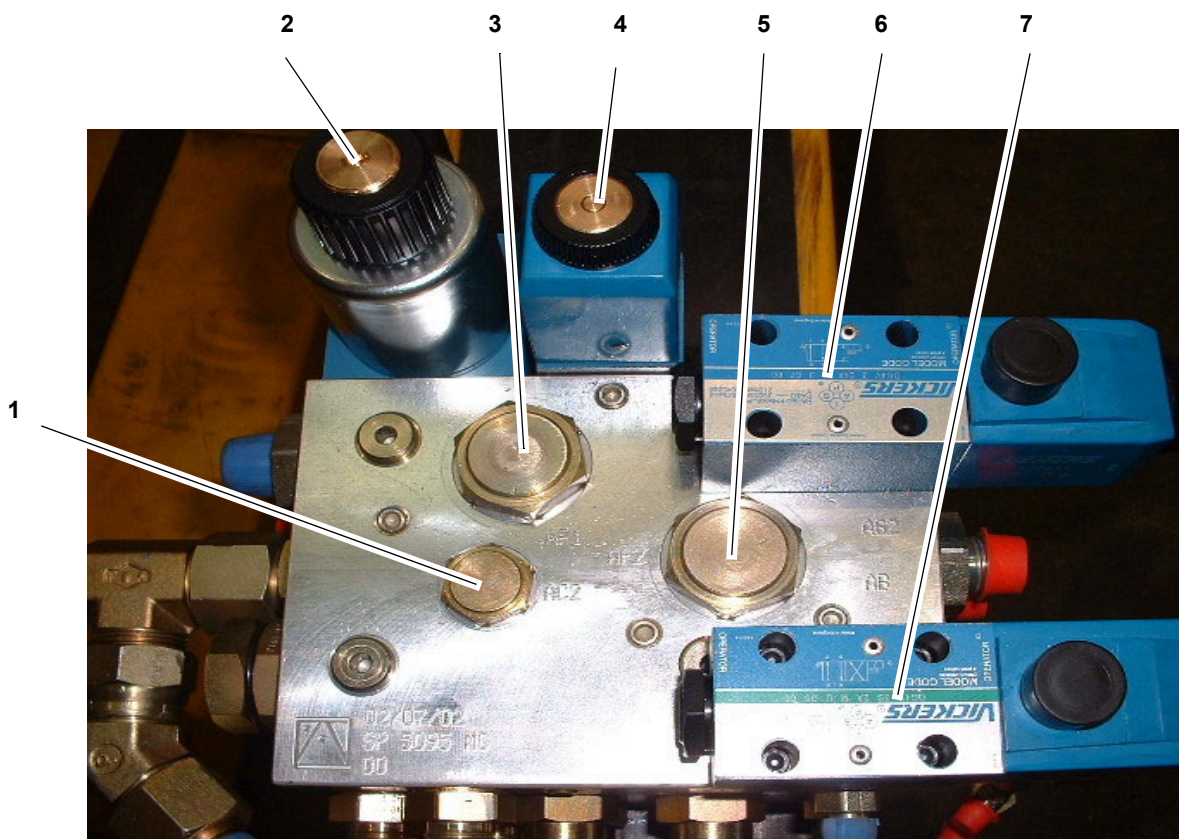

Ref	Description
8	AD1 - Equilibrating valve of front motor, only using in low speed
9	AD2 - Equilibrating valve of front motors, only using in low speed
10	AD3 - Equilibrating valve of rear motor, only using in low and high speed

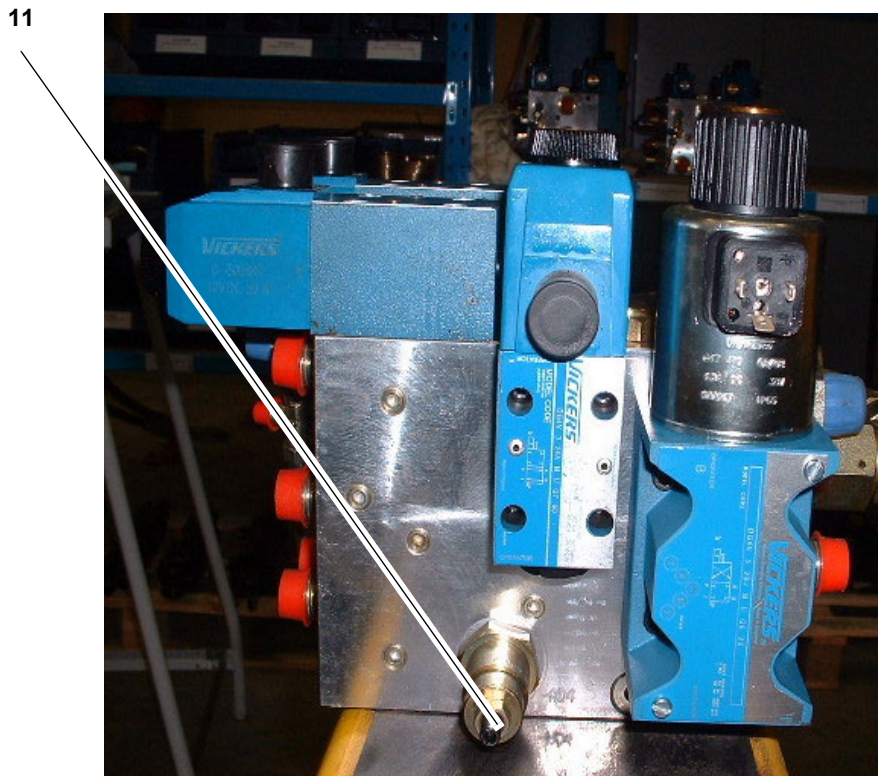
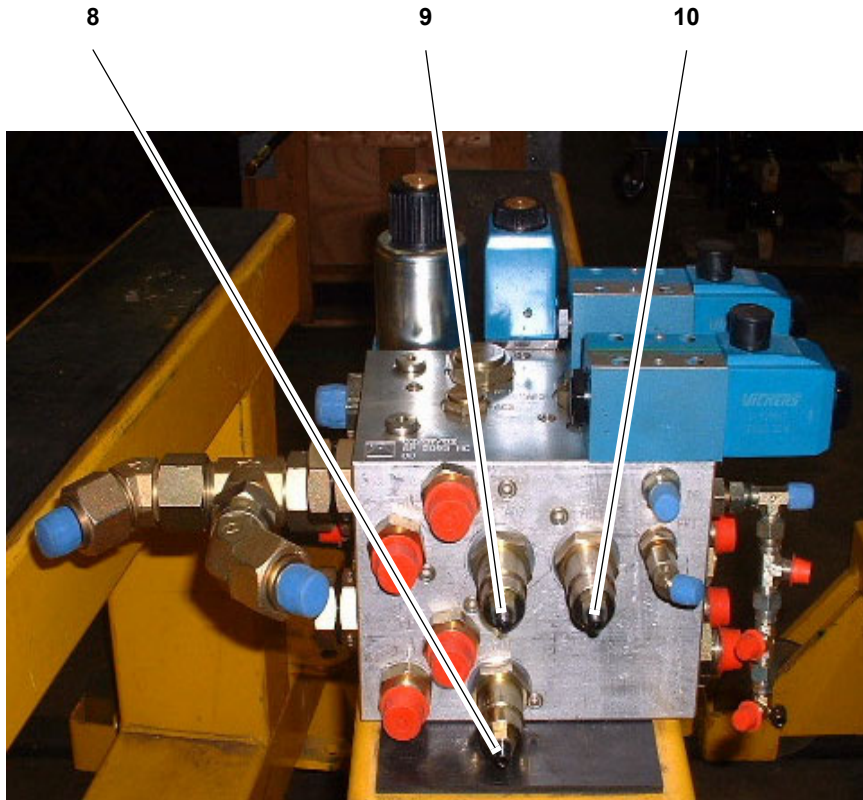

10.1.2 -Input and output

M1	Rear right engine feeding outlet
M2	Rear left engine feeding outlet
M3	Common outlet for both front driving engines
B2	Front left engine feeding outlet
B3	Rear left engine feeding outlet
A2	Rear right engine feeding outlet
A3	Rear left engine feeding outlet
FR2	Stroke volume change driving engines feeding outlet
DR	Engines drain return
P1	Pressure input coming from proportional Danfoss valve, outlet A from YV7, passage n° 2 from slewing collector
B1	Pressure input coming from proportional Danfoss valve, outlet A from YV6, passage n° 1 from slewing collector
P2	Pressure input coming from proportional Danfoss valve, outlet B from YV7, passage n° 3 from slewing collector
FR1	Unbreaking supply from steering in stop mode
A1	Pressure input coming from proportional Danfoss valve, outlet B from YV6, passage n° 4 from slewing collector

10.2 - PVG 32 DANFOSS BLOCK

10.2.1 -Location

Ref	Description
1	YV2 - Non proportional valve from PVG32, supply of non proportional functions
2	YV9 - Proportional valve boom lift from boom - B = output, A = input
3	YV10 - Proportional valve arm lift from boom - B = output, A = input
4	YV11 - Proportional valve for rotation command
5	YV14 - Proportional valve for driving command, output A towards input 1 towards slewing ring, output B towards input 4 from slewing ring
6	YV15 - Proportional valve for driving command, output A towards input 2 towards slewing ring, output B towards input 3 from slewing ring
7	YV1 - LS valve for pressure and flow control with proportional pump command

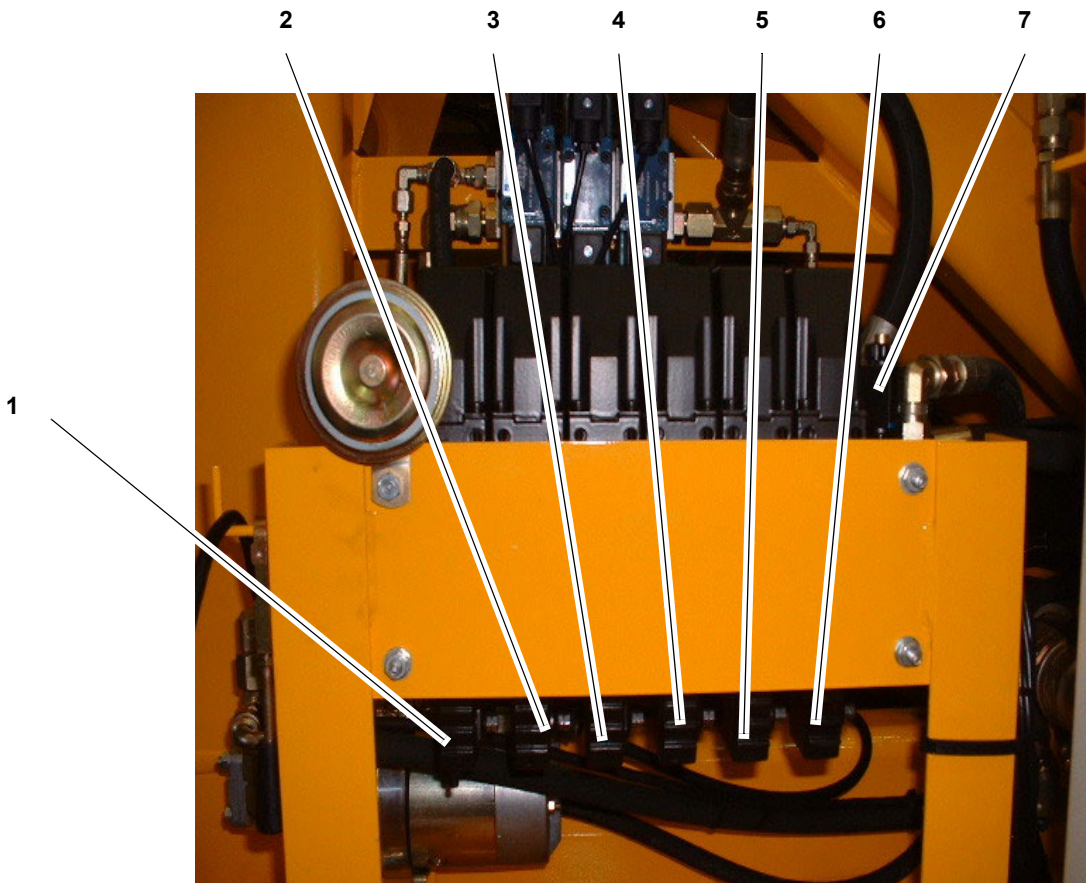

10.2.2 -Input and output

M	Minimess plug, for measuring the working pressure inside the circuit
LS	Output towards pump, plate angle supply control inside the proportional pump (pump flowrate control)
P	Pressure output inside proportional PVG block
YV7 A & B	Supply feeding for driving towards driving block, output A towards outlet 2 from slewing ring and input P1 from driving block. output B towards outlet 3 from slewing ring going in P2 from driving block
YV6 A & B	Supply feeding for driving towards driving block, output A towards outlet 1 from slewing ring and input B1 from driving block. output B towards outlet 4 from slewing ring going in A1 from driving block
YV5 A & B	Supply output for slewing turntable engine, equipped with 2 pressure adjustment set at 100 bars (1450 PSI)
YV4 A & B	Supply output for 1st boom lift, output A 1st boom raising, output B 1st lifting
YV3 A & B	Supply output for 2nd boom lift, output A 2nd boom raising, output B 2nd lifting
YV2 A & B	Supply output for non proportional movements. Output A, Cetop supply YV14 A and B, output B auxiliary block supply with YV15 A and B, YV19 A and B, YV18 A and B pressure sent towards outlet 6 from slewing ring towards steering block command. Valves supply YV21 A and B and YV22 A and B

10.3 - CETOP 3 AUXILIARY BLOCK

10.3.1 -Location

Ref	Description
1	YV2 - Non proportional valve from PVG32, supply of the non proportional functions
2	YV9 - Proportional valve for boom lifting supply - B = output, A = input
3	YV10 - Proportional valve for arm lifting supply B = output, A = input
4	YV11 - Proportional valve for rotation command
5	YV14 - Proportional valve for driving command, output A towards input 1 of slewing ring, output B towards input 4 of slewing ring
6	YV15 - Proportional valve for driving command, output A towards input 2 of slewing ring, output B towards input 3 of slewing ring

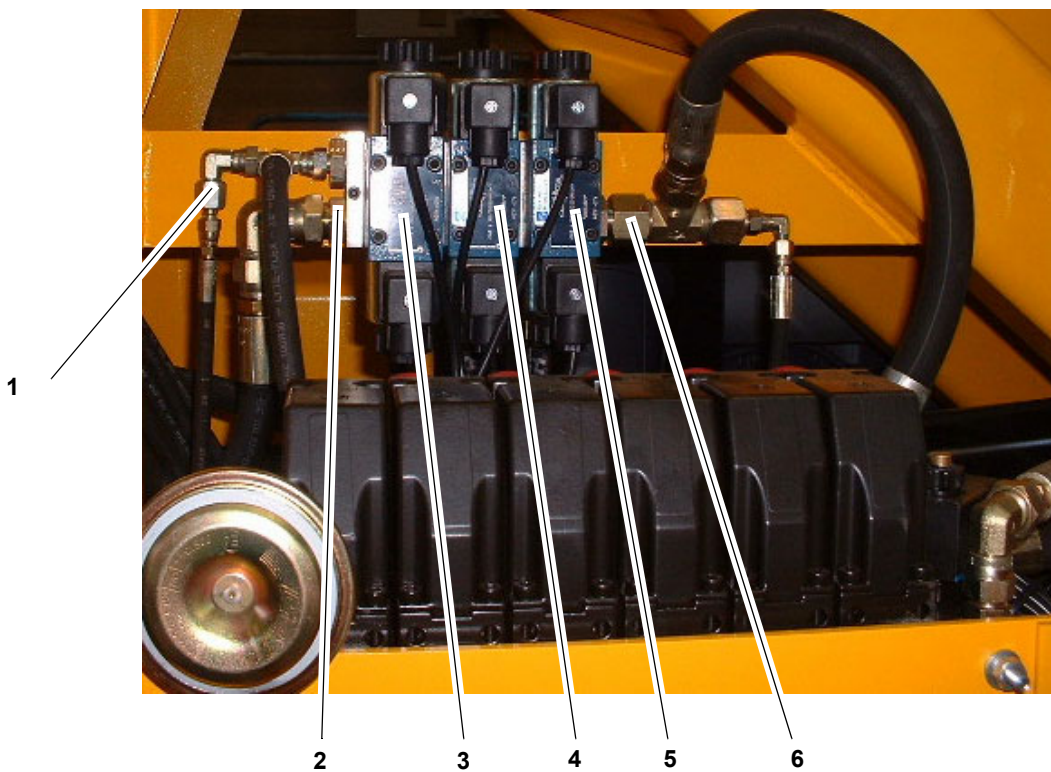

10.4 - EMERGENCY PUMP UNIT

10.4.1 -Location

Ref	Description
1	Emergency pump pressure regulator
2	Emergency electric pump

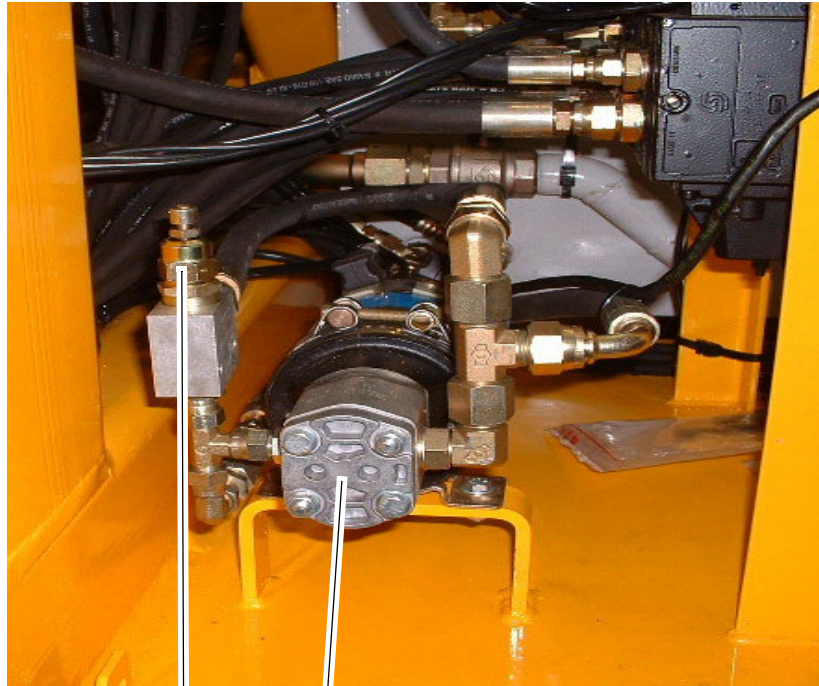

1

2

10.5 - TELESCOPING BLOCK

10.5.1 -Location

Ref	Description
1	Telescop supply output, way to telescop output
2	Telescop supply output, way to telescop input
3	Telescope input entry pressure regulator set at 200 Bars (2900 PSI)
4	Telescope outlet pressure regulator set at 150 Bars (2175 PSI)
5	Telescope output valve
6	Telescopue input valve

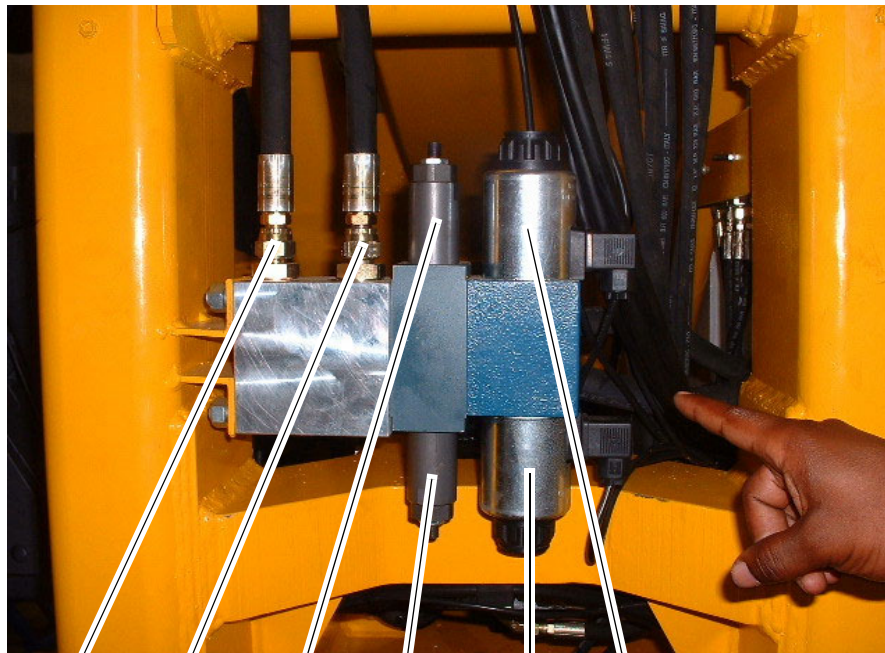

1 2 3 4 6 5

10.6 - STEERING BLOCK CONTROL

10.6.1 -Location

Ref	Description
1	YV22 A - Front right steering
2	YV21 A - Rear left steering
3	YV22 B - Front left steering
4	YV21 B - Rear right steering

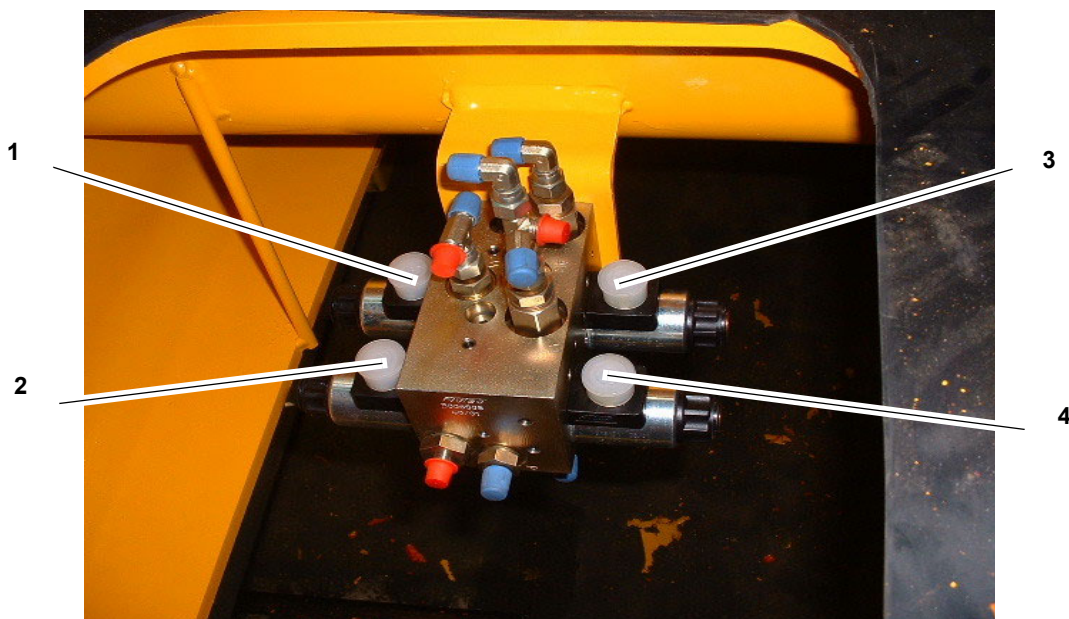

10.6.2 -Input and output

P	Input of block feeding
T	Output, return to tank
4/2	Output, unbreaking supply when steering is stopped when no drive
A1 & B1	Front steering cylinder supply A1 = big chamber, B1 = small chamber
A2 1 B2	Rear steering cylinder supply A2 = small chamber, B1 = big chamber

11 - HYDRAULIC EQUATIONS

11.1 - TRAVEL

PV: YV1 + YV6 & YV7

GV: YV1 + YV6 & YV7 + YV10 + YV 12

Differential blocking : YV13

11.2 - TURNTABLE ROTATION

YV1 + YV5 A or B

11.3 - ARM LIFTING

YV1 + YV4 (B = up, A = down)

11.4 - BOOM LIFTING

YV1 + YV 3 (B = up, A = down)

11.5 - TELESCOPING

YV1 + YV 2A + YV 14 (A = out, B = in)

11.6 - OTHER MOVEMENT

YV1 + YV2B +

Jib =YV 18 (A = up, B = down)

or

Platform rotation =YV 19 A or B

or

Manual compensation =YV15 A or B

or

Steering front axle =YV 21 A or B

or

Steering rear axle = YV22 A or B

12 - MAINTENANCE

12.1 - GENERAL RECOMMENDATIONS

The maintenance operations indicated in this manual are given for normal conditions of use.

In difficult conditions: extreme temperatures, high humidity, polluting atmosphere, high altitude, etc., some operations must be carried out more frequently and special precautions must be taken. Refer to the engine manual and your local PINGUELY-HAULOTTE agent.

Only qualified and competent personnel can carry out any work on the machine and they must comply with the safety instructions relating to the protection of personnel and environmental protection.

Regularly check the operation of the safety devices:

- * Tilt : buzzer + stop (travel cut as well as boom raising, arm raising and telescope extension).
 - * Platform overload - load > permitted load (see tables, corresponding paragraph, Chapter 2.6, page 15), buzzer + complete stopping of all movements, except basket rotation.
- 1° High speed impossible (or intermediate speed for 4x4 model) if boom raised, arm raised, telescope extended.



Attention !

Do not use the machine as a welding earth.

Do not weld without disconnecting the battery's(+) and(-) terminals.

Do not start other vehicles with the batteries connected.

12.2 - PARTICULAR RECOMMENDATIONS

Before any maintenance intervention on the elevating platform, indicate on the turntable and platform control stations that the machine is being serviced. If possible, restrict access to the elevating platform to intervention personnel only.

12.2.1 -Specific tools

Personnel should therefore be familiar with the use of the specific tools used (measurement device, torque tightening device, lifting apparatus, etc.) and respect the operating limits specified in the documentation that is supplied with the tools.

Incorrect use of a tool (incorrect adjustment after a reading error) may lead to premature deterioration of the elevating platform (or more seriously, an accident), for which PINGUELY-HAULOTTE cannot be held responsible.

12.2.2 -Replacing an element

Before replacing an element, the machine must be put in the maintenance configuration (see corresponding paragraph) and the electric power supply cut off (see corresponding paragraph).

All distributing valves are "with open centre": breaking the electric circuit therefore decreases pressure in the hydraulic circuits, up to the non-return valves flanged on the cylinders. An element can be replaced safely, if the procedures described in the maintenance sheets are respected (unscrew hydraulic connectors slowly to release residual pressure).

To preserve the integrity of the safety systems and the technical characteristics of the elevating platform, it is essential to use original parts and to respect the initial setting and tightening torque values (see corresponding paragraph).

12.2.3 -Locating the breakdown

Certain checks require the elevating platform to be switched on. In this case, personnel must ensure:

- that the measurement devices used are properly insulated,
- that they do not touch the live parts,
- that they are not wearing or carrying metal objects that may deteriorate the live components (e.g.: dropping a spanner during an intervention on the batteries).

12.3 - MAINTENANCE SYSTEM

:Photo 1

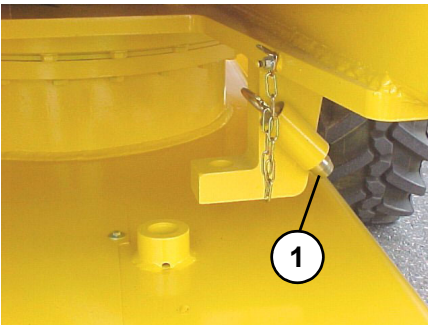

Instructions

Maintenance configuration:

- Position the elevating platform on a firm, horizontal surface.
- If possible, fold the machine completely. Otherwise, for specific operations, put the various components into slings.
- Put the turntable rotation blocking pin into place (ref Photo. 1, page 62).

Restoring operational configuration:

- Remove the blocking pin (ref. 1 Photo. 1, page 62).

12.4 - ELECTRIC POWER SUPPLY

Instructions

Cutting off the electric power supply:

- Press the turntable emergency stop (ref 1 Photo. 2, page 63).

Restoring the electric power supply:

- Reset the emergency stop (ref 1 Photo. 2, page 63).

:Photo 2 .

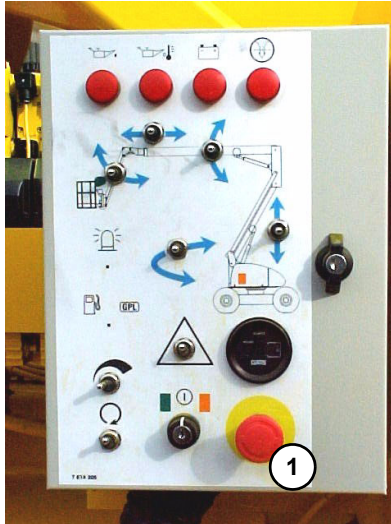









12.5 - MAINTENANCE PLAN

The plan shows the frequency, area of maintenance (device) and the consumables to be used.

The reference shown in the symbol shows the area maintained based on the frequency.

- The symbol represents the consumable to use (or the operation to be carried out).

CONSUMABLE	SPECIFICATION	SYMBOL	Lubricants used by PINGUELY-HAULOTTE	ELF	TOTAL
Engine oil	SAE 15W40		SHELL RIMULAX		
Gearbox oil	SAE 90		SHELL SPIRAXA EP80W90	TRANSELF	TM 80 W/90
Hydraulic oil	AFNOR 48602 ISO VG 46		SHELL TELLUS T46	HYDRELF DS 46	EQUIVIS ZS 46
Organic hydraulic oil (option)	HF - E 46		SHELL Naturelle HF-E46		
Lithium extreme pressure grease	ISO - XM - 2				
Lead-free grease	Grade 2 ou 3		ESSO GP GREASE	MULTIMOTIVE 2	MULTIS EP 2
Replacement or special operation					
Grease			Ceplattyn KG 10 HMF		FUCHS
Grease			Energrease LS - EP2		BP

HOURS

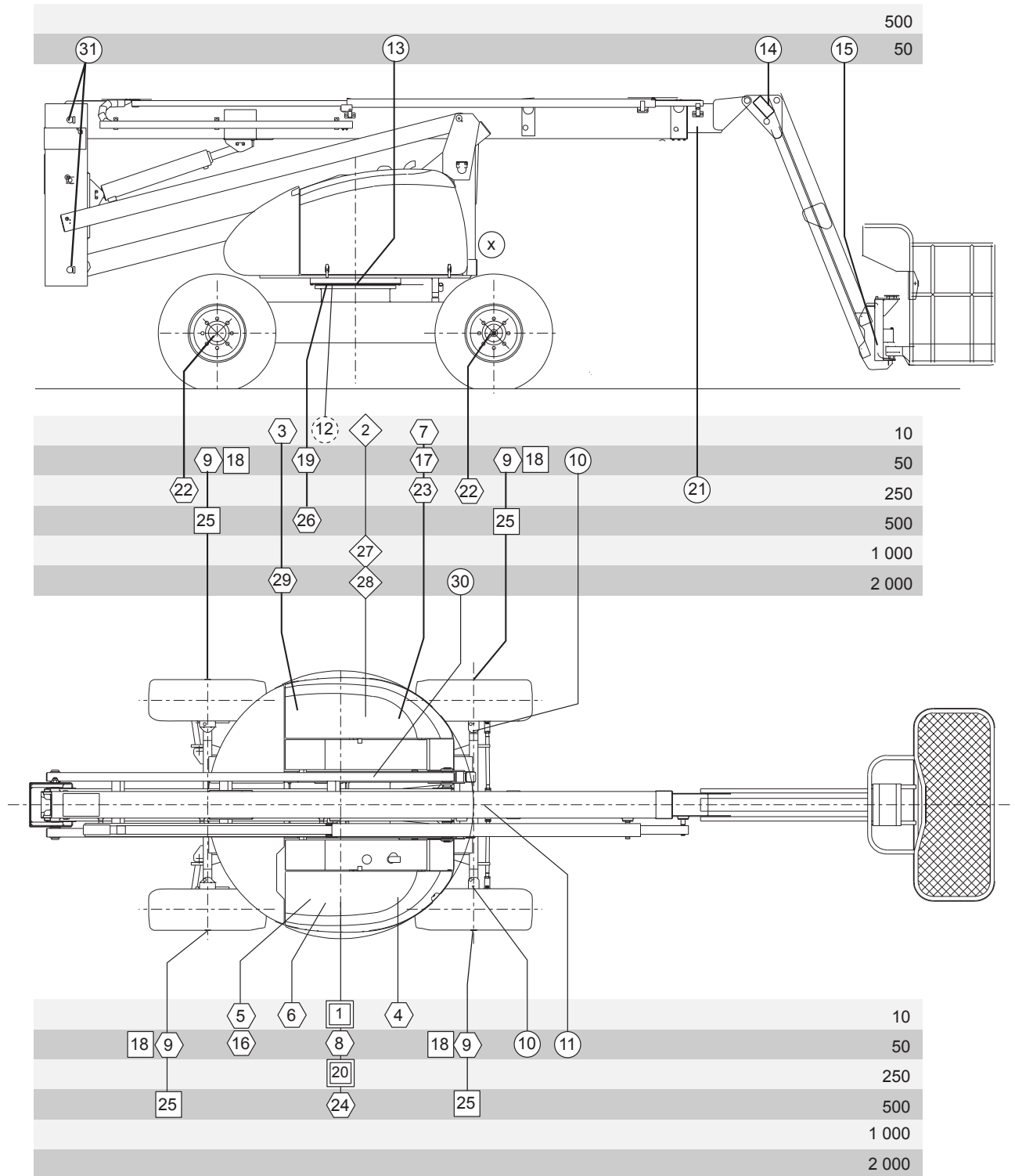

12.6 - OPERATIONS.

12.6.1 -Summary table

PERIODICITES	OPERATIONS	REPERES
Each day or before each putting into service	<ul style="list-style-type: none"> • Check the following levels: <ul style="list-style-type: none"> - engine oil - hydraulic oil - diesel - electric batteries • Check the cleanness of the following: <ul style="list-style-type: none"> - gasoil pre-filter - engine air filter - machine (check in particular the watertightness of the connectors and hoses), take this opportunity to check the condition of the tyres, cables and all accessories and equipment. • Check the clogging of the hydraulic oil filter: an indicator indicates clogging; change the cartridge when the mark appears. 	<p>1</p> <p>2</p> <p>3</p> <p>4</p> <p>5</p> <p>6</p> <p>7</p>
Every 50 hours	<ul style="list-style-type: none"> • Engine: see engine manufacturer's manual • Check the level of the drive wheel reducers (see Chapter 5.3.2.2, page 49) • Grease: <ul style="list-style-type: none"> - the wheel pivot pins: 8 points - steering axle, centre pivot and slot pin: 10 points - slewing ring : bearing (2 points) - slewing ring : teeth (brush) - pendular hinge pin: 2 points - pendular link piece hinge pin: 4 points - boom bottom shaft: 1 point • Clean gasoil pre-filter 	<p>8</p> <p>9</p> <p>10</p> <p>11</p> <p>12</p> <p>13</p> <p>14</p> <p>15</p> <p>31</p> <p>16</p>
After the first 50 hours	<ul style="list-style-type: none"> • Change the hydraulic filter's cartridge (see 250 hour interval) • Drain the drive wheel reducers (see 500 hour interval) <ul style="list-style-type: none"> - 2 points for 4x2 model - 4 points for 4x4 model • Check the tightness of the slewing ring screws (torque: 27 daNm) 	<p>17</p> <p>18</p> <p>19</p>
Every 250 hours	<ul style="list-style-type: none"> • Engine: see engine manufacturer's manual • Grease the telescope's friction parts (spatula) • Check the condition of the telescopic cylinder friction pads • Check the tightness of the wheel nuts (torque: 32 daNm) • Change the hydraulic filter's cartridge 	<p>20</p> <p>21</p> <p>22</p> <p>23</p>
Every 500 hours	<ul style="list-style-type: none"> • Engine: see engine manufacturer's manual • Drain the wheel reducers. Fill up again: capacity : 4 x 1.4 l • Ring screw : check tightness and tighten if necessary (torque: 27 daNm) 	<p>24</p> <p>25</p> <p>26</p>
OPTION : every 500 hours or every 6 months	<ul style="list-style-type: none"> • Empty the hydraulic oil tank completely if you have the «organic hydraulic oil» option 	<p>27</p>
Every 1000 hours or every year	<ul style="list-style-type: none"> • Engine: see engine manufacturer's manual • Drain the hydraulic oil reservoir 	<p>27</p>
Every 2000 hours	<ul style="list-style-type: none"> • Engine: see engine manufacturer's manual • Drain the hydraulic oil complete circuit and reservoir • Drain and clean the diesel tank • Grease: rotation reducer: 1 point 	<p>28</p> <p>29</p> <p>30</p>

REMINDER :All these intervals must be reduced if working in difficult conditions (refer to the After-Sales Department if necessary).

12.7 - PRESENCE OF LABELS

Make sure that the labels and plates informing personnel of the various dangers related to machine use are in good condition.

The labels informing operators on the use and maintenance of the machine must also be in good condition.

An illegible label may result in incorrect or dangerous use of the machine.

Instructions:

Check that the labels are present:

Check that all the labels described below are legible and in place. Replace them if necessary (additional copies can be supplied on request, if necessary).

12.7.1 -Common "yellow" label

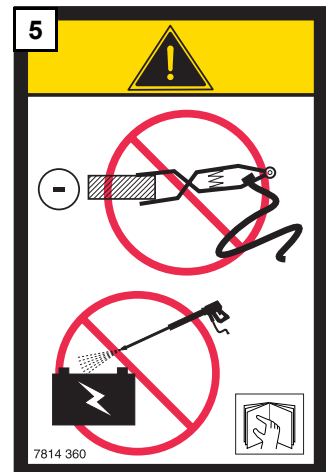
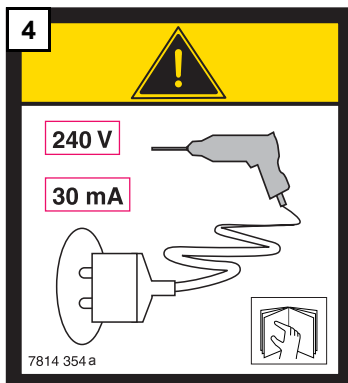
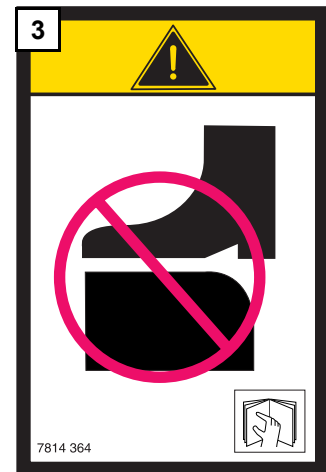
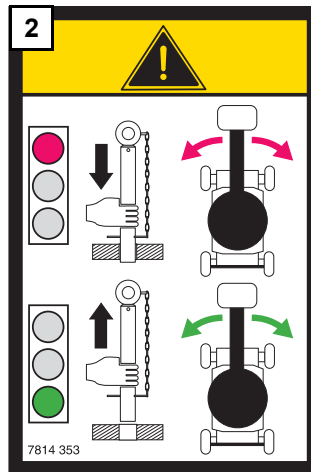
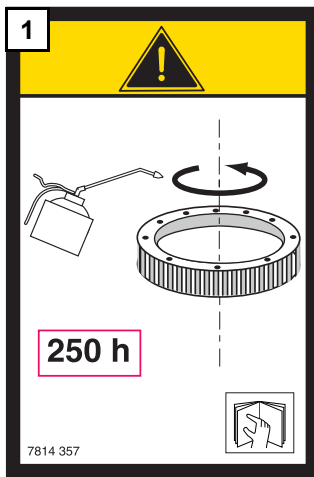

12.7.2 -Commom "orange" label

6	
CONSIGNE D'UTILISATION	
POUR UTILISER CET APPAREIL L'OPERATEUR DOIT	
<ol style="list-style-type: none"> 1 - Lire et comprendre les informations contenues dans le manuel de conduite et les inscriptions apposées sur la machine, se familiariser avec les commandes. 2 - Etre formé et entraîné pour la conduite de celui-ci, sous la responsabilité de son employeur. 3 - Assurer correctement l'entretien suivant le catalogue constructeur. 4 - Ne pas utiliser l'appareil en cas de dysfonctionnement. 5 - Ne pas laver sous pression les composants électriques. 6 - Ne rien démonter, la stabilité serait modifiée. 7 - Ne pas modifier l'appareil sans accord du constructeur. 8 - Ne pas utiliser la machine comme masse de soudure. 9 - Ne pas souder sur la machine sans déconnecter les cosses des batteries, se référer à la notice de conduite et d'entretien. 	
INSPECTION JOURNALIERE	
<ol style="list-style-type: none"> 1 - Vérifier le niveau d'huile hydraulique et le liquide des batteries. 2 - Vérifier s'il n'y a pas de signe apparent de défectuosité (fuite hydraulique, boulonnerie, liaisons électriques). 3 - Vérifier le fonctionnement de l'indicateur de devers en faisant fonctionner l'alarme sonore. 	
INSTRUCTION AVANT UTILISATION	
<ol style="list-style-type: none"> 1 - Enlever la broche de blocage d'orientation (s'il y a une tourelle). 2 - IMPORTANT. La prise doit être raccordée sur une installation électrique protégée par un disjoncteur différentiel 30 mA (NORME C15 100) 	
MISE EN ROUTE	
<ol style="list-style-type: none"> 1 - Déverrouiller l'arrêt d'urgence, puis actionner le bouton de démarrage. 2 - En cas de non fonctionnement, attendre 10 s et renouveler l'opération. 	
INTERDICTION D'UTILISER L'APPAREIL PENDANT LA CHARGE DES BATTERIES	
<small>7814 342</small>	

12.7.3 -Common "red" label

7



.F Composant spécifique à cette machine.
NE PAS INTERCHANGER.

.GB Component specific to this machine.
DO NOT INTERCHANGE.

.D Komponenten nur für diese Maschine geeignet.
BITTE AUF EINE ANDERE MASCHINE NICHT MONTIEREN.

N MACHINE - MASCHINE N

7814 518

8

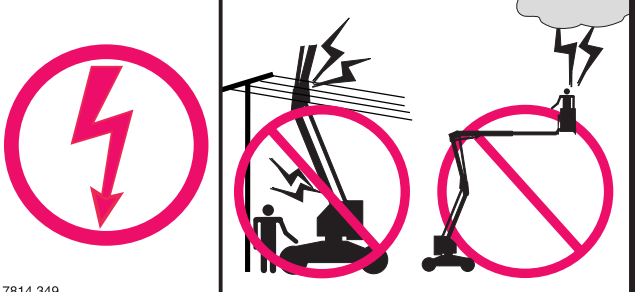
7814 349

9

7814 388

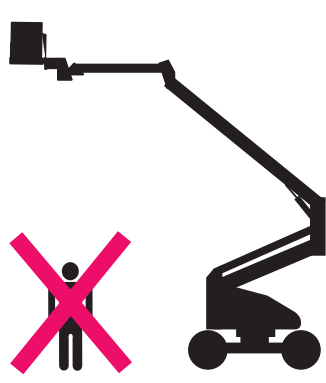
10



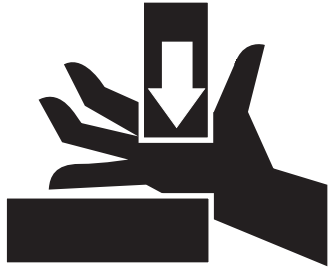

7814 363

11

7814 362

12

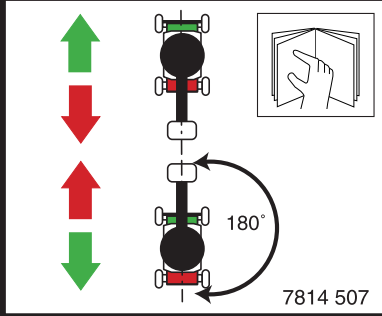
7814 507

12.7.4 -Other common label

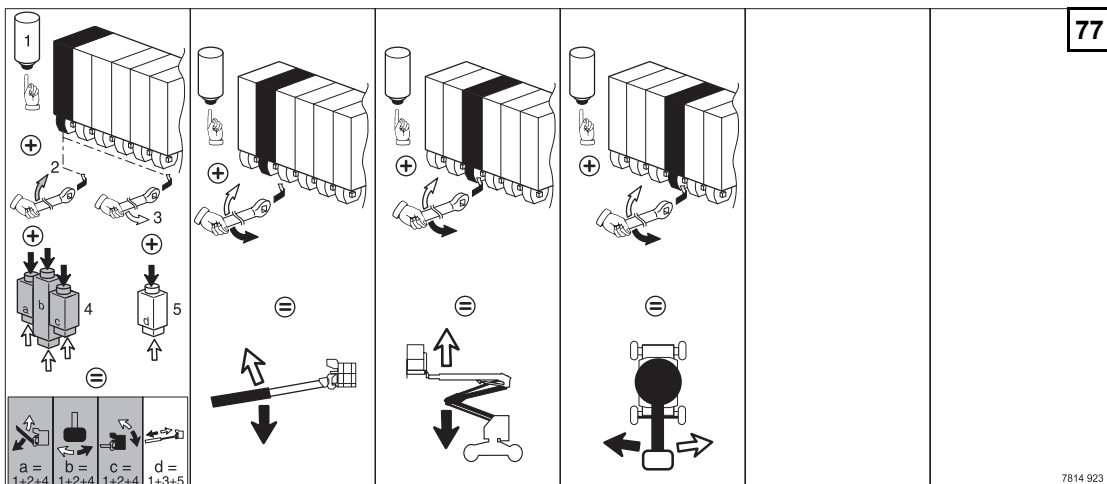
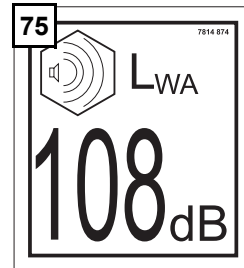
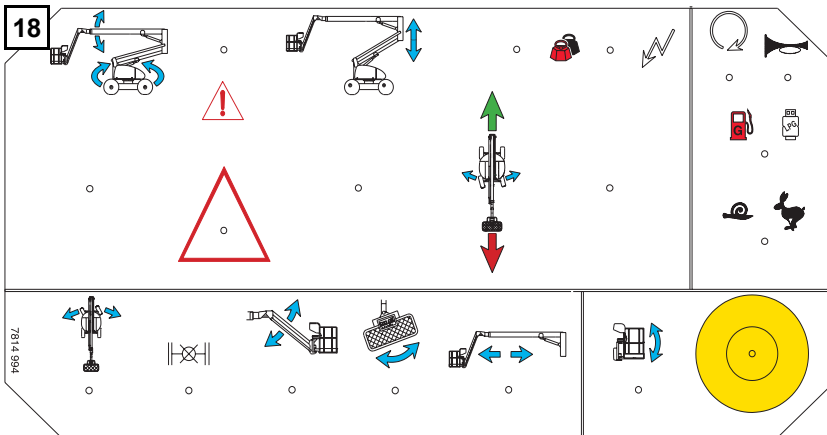
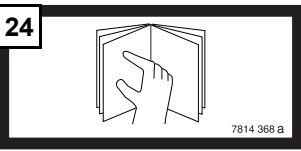
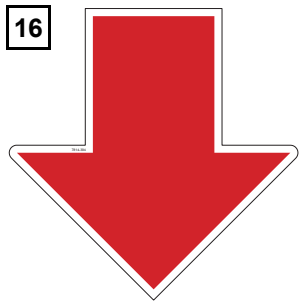
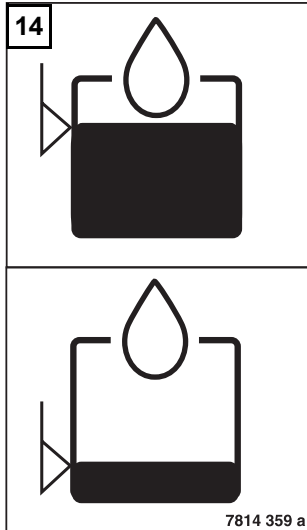
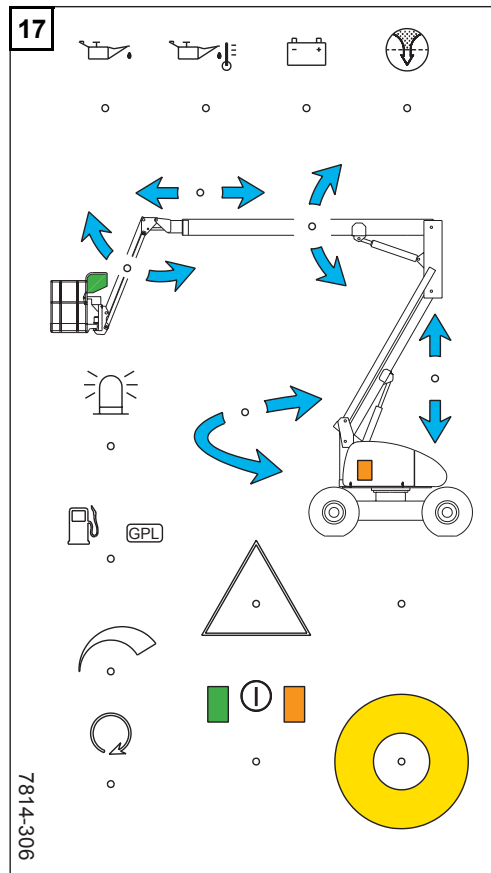
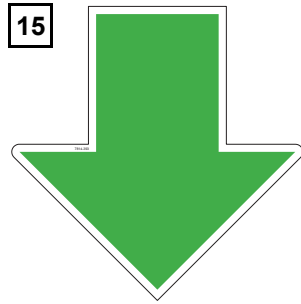
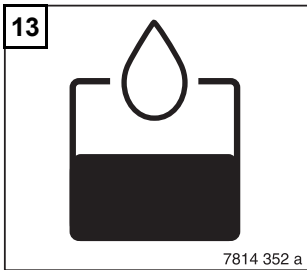

12.7.5 -Model-specific labels

12.7.5.1 -HA20PX

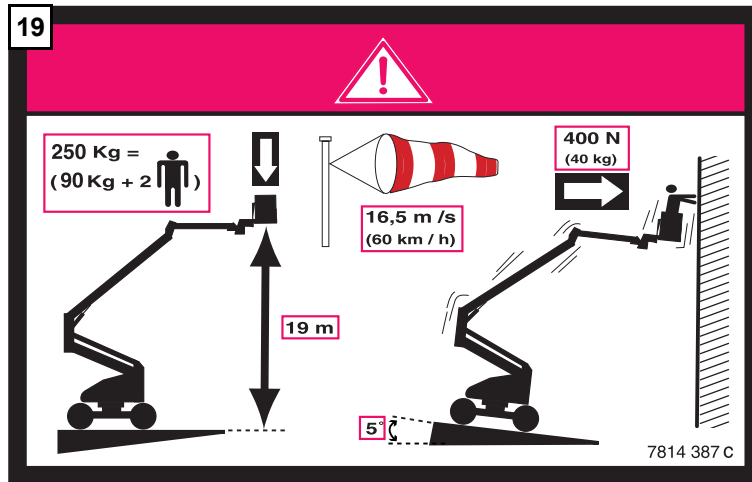

12.7.5.2 -HA26PX

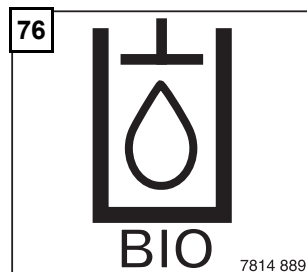
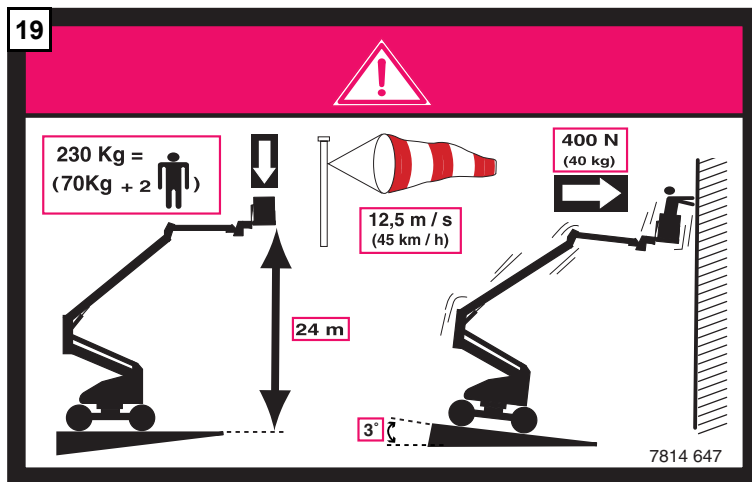

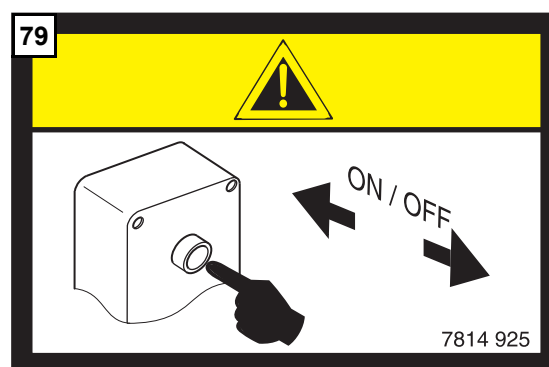
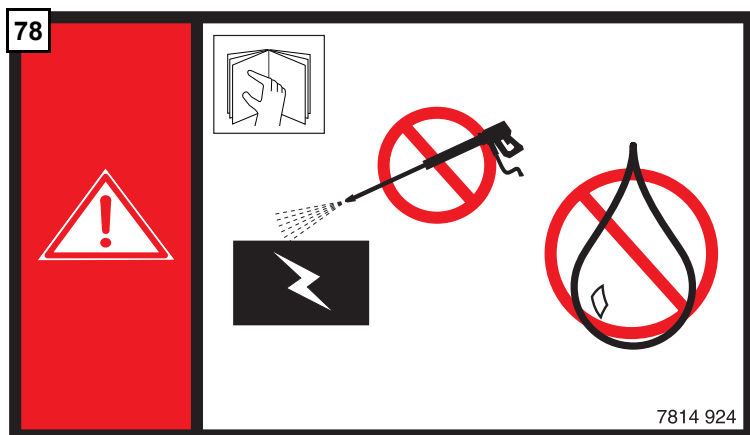

12.7.6 -Description

Ref	Code	Qty	Description
1	30 7814 3570	1	Ring lubrication
2	30 7814 3530	2	Remove the pin
3	30 7814 3640	2	Do not stand on the cover
4	30 7814 3540 a	1	The plug must be connected
5	30 7814 3600	2	Do not use as an earth
4	30 7814 5730	1	240V plug position (Holland)
6	30 7814 3420	1	Operating instructions
7	30 7814 5180	1	Do not interchange
8	30 7814 3490	1	Machine uninsulated
9	30 7814 3880	2	Do not stop in the work area
10	30 7814 3630	2	Risk of body crushing
11	30 7814 3620	2	Risk of hand crushing
12	30 7814 5070	1	Travel direction danger
13	30 7814 3520	1	"Hydraulic oil" label
14	30 7814 3590	1	Oil level
15	3 07814 3930 a	1	Green arrow
16	30 7814 3940 a	1	Red arrow
17	30 7814 3060	1	Chassis control panel
18	30 7814 9940	1	Platform control panel
19	30 7814 3870 c	2	Floor height + load HA20 PX
19	30 7814 6470	2	Floor height + load HA26 PX
24	30 7814 3680	1	Read user manual
26	B12759		"HAULOTTE" logo
27	30 7814 3240 a	1	Manufacturer's plate
28	30 7814 7650	1	Name logo
29	S2954		"HAULOTTE" logo
75	30 7814 8740	1	Acoustic power
77	3078149230	1	Manual trouble-shooting
78	30 7814 9240	2	Do not spray water near the built-in generator
79	30 7814 9250	1	Built-in generator ON button
80	242 180 8660		Yellow and black reflective adhesive marking

12.7.7 -Label positioning

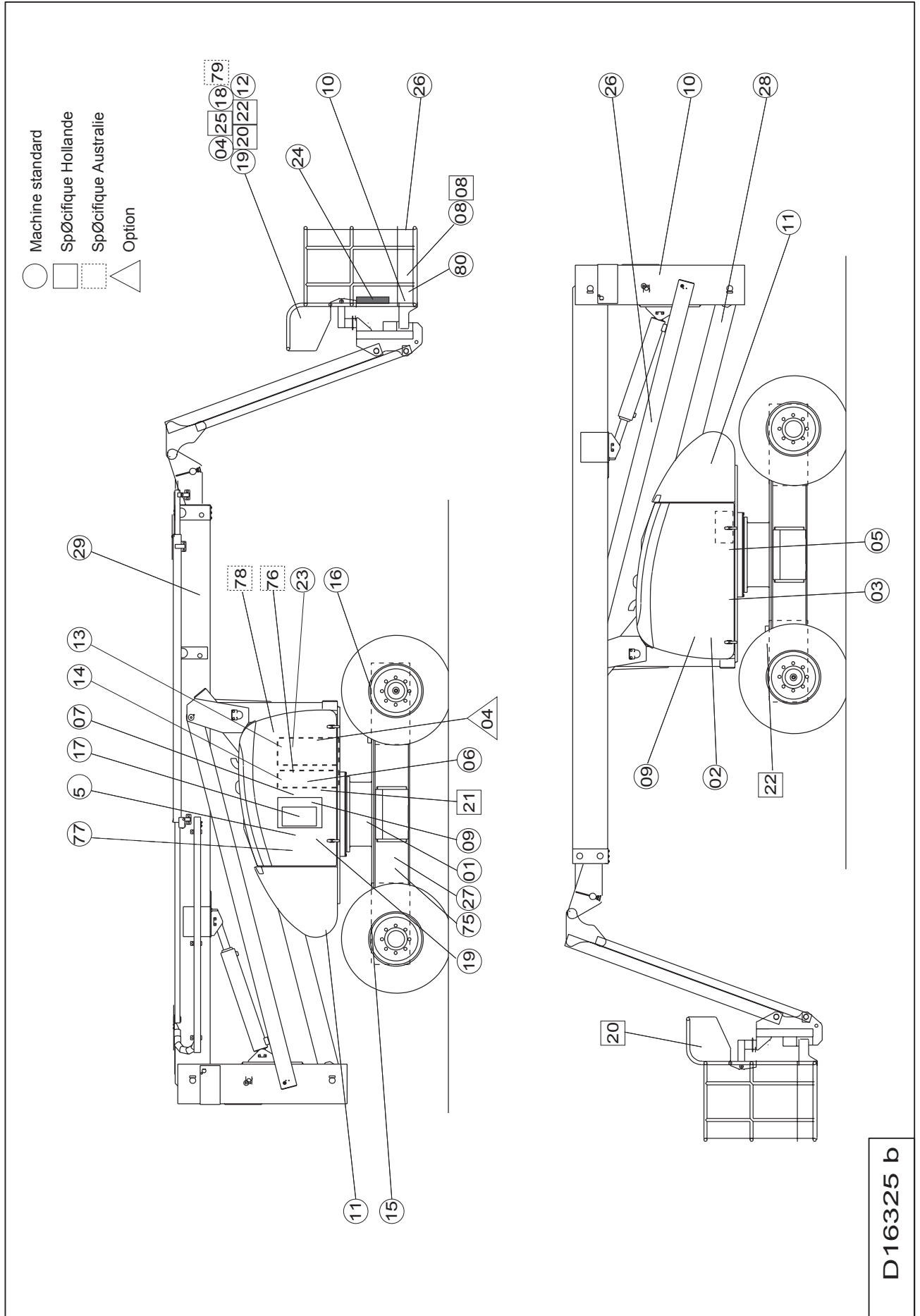

12.8 - PRESENCE OF MANUALS

It is important to ensure that the manuals supplied with the machine are in good conditions and stored in the document holder provided on the platform.

An illegible manual may lead to incorrect or dangerous use of the machine

Operating instructions:

Check presence of manuals:

Check that all the manuals are legible, complete and stored in the document holder provided on the platform. Replace if necessary (extra copies can be supplied on request by the manufacturer).

13 - PREVENTIVE MAINTENANCE SHEET

List of maintenance preventive sheets:

<i>Sheet no.</i>	<i>Description</i>
P005	Checking - filling the hydraulic oil tank
P006	Changing the hydraulic filter cartridge
P007	Checking - changing the oil of a wheel reducing gear

Sheet P005	PREVENTIVE MAINTENANCE SHEET	Folio 1/1
	CHECKING - FILLING THE HYDRAULIC OIL TANK	

1 - Preliminary operations

- Put the machine in the maintenance configuration (see corresponding paragraph).
- Switch off electric power (see corresponding paragraph).

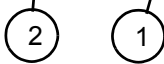

HA16/18PX - HA46/51JRT

2 - Checking - filling the hydraulic oil tank

NB: This operation must be carried out when the oil is cold, i.e. before starting the machine.

- Check that the level of oil (1) in the tank is between the high and low levels when cold.
- Top up if necessary, by filling via the cap (2).

NB: Only use the oil recommended by the manufacturer.

- Put the machine back into the operational configuration.

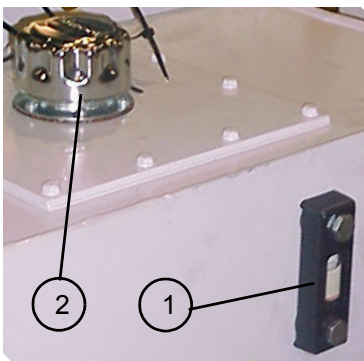

HA16/18PX New Design
HA46/51JRT

Sheet P006	PREVENTIVE MAINTENANCE SHEET	Folio 1/1
	CHANGING THE HYDRAULIC FILTER CARTRIDGE	

 **Caution!**
Use a container to collect oil to prevent pollution of the environment.

2 - Preliminary operations

- Put the machine in the maintenance configuration (see corresponding paragraph).
- Switch off electric power (see corresponding paragraph).

2 - Replacing the hydraulic filter cartridge

NB: *The filter has a clogging indicator. Clogging should be checked when the machine is hot, otherwise, the indicator may be visible due to the viscosity of the cold oil.*

- Change the cartridge (1) if the clogging indicator appears (2).
- Unscrew the base nut (3) and remove the cartridge from the hydraulic filter.
- Screw a new cartridge into place.
- Put the machine back into the operational configuration.

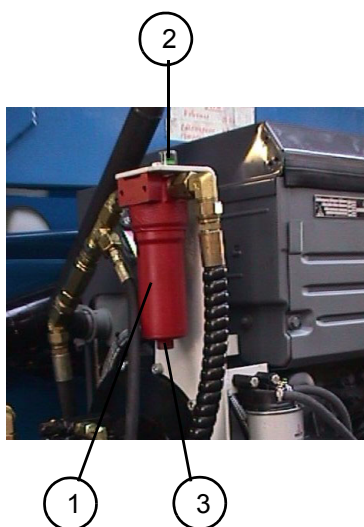

HA16/18 PX
 HA46/51JRT
 HA20/26 PX
 HA61/80JRT

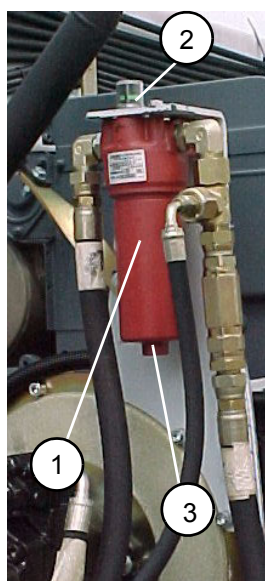

H14P / H16TP
 HB40/44J

	PREVENTIVE MAINTENANCE SHEET	

Sheet P007	PREVENTIVE MAINTENANCE SHEET	Folio 1/1
	CHECKING - CHANGING THE OIL OF A WHEEL REDUCING GEAR	



Caution!

Use a container to collect oil to prevent pollution of the environment.



Caution!

Make sure that the machine is properly stabilised, and that the lifting means are in good condition and of sufficient capacity.

3 - Preliminary operations

- Put the machine in the maintenance configuration (see corresponding paragraph).
- Switch off electric power (see corresponding paragraph).

2 - Checking the level

- Turn the wheel so that one cap (1) is on a horizontal line and the other (2) is on a vertical line.
- Unscrew the cap (1) and check the level that should be up to the hole. Top up if necessary.
- Screw the cap back into place.

NB: *Only use the oil recommended by the manufacturer.*

3 - Changing the oil

- In the same position, unscrew the 2 caps and let the oil flow out.
- Re-fill as described above.
- Screw the caps back into place.

NB: *Collect old oil to prevent pollution of the environment.*

4 - Additional operations

- Put the machine back into the operational configuration.



HA16/18PX - HA46/51JRT
HA20/26 PX - HA61/80JRT



H14T(X) - H16TP(X)
HB40/44J

	PREVENTIVE MAINTENANCE SHEET	

14 - OPERATING INCIDENTS

14.1 - INCIDENT TABLE

Before diagnosing a failure, check that:

- the fuel tank is not empty,
- the batteries are properly charged,
- the turntable and platform "palm button" emergency stop buttons are unlocked,
- the relays (platform control panel - turntable box) are correctly pushed into their compartments, (see corresponding paragraph).
- the main tank oil level is OK,
- the state of the fuses, (see corresponding paragraph).
- the electrovalves are working properly by checking the state of the LEDs in the turntable box.

Check the state of the LEDs (see corresponding paragraph):

The LEDs inside the turntable box indicate the state of the electrovalves:

- LED off: electrovalve present and not controlled,
- LED on: electrovalve present and controlled.

NB: If an electrovalve is not connected, the corresponding LED is permanently on.

Instructions:

- Identify the defective function.
- Machine power on but not started: check the presence of the electrovalves (LED off).
- No electrovalve should be controlled (LED on).
- Check that the outputs corresponding to the function are active using the LEDs and directly on the electrovalve heads.
- If they are not active, check which inputs create the function.
- Test the inputs with a voltmeter.

14.1.1 -General operation

ANOMALY	PROBABLE CAUSE	SOLUTION
The motor does not start, the starter is activated	<ul style="list-style-type: none"> • Diesel tank empty • Fuse FU1 defective • Diesel supply circuit defective • Wiring defective • Module U1 defective • Stop motor solenoid YA1 defective 	Fiche DP066
The motor does not start, the starter is not activated	<ul style="list-style-type: none"> • Emergency stop locked • Generator defective • Batteries defective • Fuses FU1, FU4 or FU8 defective • Wiring defective • Switch SB3 or SB4 defective • Relay KA2 defective 	Fiche DP016
The motor starts, then stops after 5s.	<ul style="list-style-type: none"> • Diesel tank empty • Diesel supply circuit defective 	Fiche DP017
The motor does not start from the platform station but does start from the turntable station	<ul style="list-style-type: none"> • Fuse FU6 defective • Defective connection of switch SB4 • Switch SB4 defective • Wiring harness defective 	Fiche DP019
The motor does not start from the turntable station but does start from the platform station	<ul style="list-style-type: none"> • Switch SB3 defective • Wiring harness defective 	Fiche DP020
No motor acceleration regardless of the movement controlled from the platform	<ul style="list-style-type: none"> • Electronic module U1 defective • Wiring harness defective 	Fiche DP021
No motor acceleration by activating the accelerator switch SA2 on the turntable control station	<ul style="list-style-type: none"> • Fuse FU3 defective • Relay KT2 defective • Electronic module U1 defective • Wiring harness defective • Accelerator switch SA2 defective • Motor accelerator coil YA2 defective 	Fiche DP022
No movement available (from turntable or platform station)	<ul style="list-style-type: none"> • Insufficient hydraulic oil • Fuse FU7 or FU4 or FU10 defective • Wiring harness defective • Electrovalve YV1 defective • Incorrect "Load sensing" pressure setting • Motor-pump coupling defective • Hydraulic pump defective • Pressure limiter defective • Distribution block input module defective • Pump regulation unit incorrectly set or defective • Hydraulic pump defective • Electronic module U1 defective • Relay KMG defective • Printed circuit defective • Key switch SA1 defective 	Fiche DP023

ANOMALY	PROBABLE CAUSE	SOLUTION
No movement available from the platform control station	<ul style="list-style-type: none"> • Fuse FU1 defective • Platform control station defective • Fail-safe pedal defective • Wiring harness defective 	Fiche DP024
Noisy hydraulic pump	<ul style="list-style-type: none"> • Oil non-conform • Obstruction of the tank air vent • Suction valves closed • Defective pipes • Hydraulic pump defective • Insufficient oil level 	Fiche DP025
Insufficient pressure or power at the pump	<ul style="list-style-type: none"> • Clogged air filter • Motor speed too low • Oil leak on connector, hose or component • Clogged oil filter 	<ul style="list-style-type: none"> • Change the filter • Adjust speed • Repair or replace • Replace oil filter cartridge
No travel telescope out, boom and arm lifting, + buzzer sounding	<ul style="list-style-type: none"> • Slope or tilt >5° 	<ul style="list-style-type: none"> • First retract the telescope and lower the boom to reset
Buzzer sounding	<ul style="list-style-type: none"> • Slope or tilt > 5° • Platform load close to cut-off • Hydraulic oil temperature too high 	<ul style="list-style-type: none"> • Reset by retracting the telescope and lowering the boom • Remove load • Leave to cool
The electropump does not work	<ul style="list-style-type: none"> • Battery breaker open • Fuses broken • Defective or discharged batteries • The battery wires do not make contact 	<ul style="list-style-type: none"> • Close the battery breaker • Replace the fuses • Replace or recharge the batteries • Clean or tighten the terminals

14.1.2 -Lifting system

ANOMALY	PROBABLE CAUSE	SOLUTION
No platform up and/or down compensation movement	<ul style="list-style-type: none"> • Electrovalve YV15 or YV2 defective • Coil defective • Electronic module U1 defective • Wiring harness defective • Printed circuit defective • Compensation switch SA5 defective • Lifting manipulator defective 	Fiche DP026
No platform right and/or left rotation movement	<ul style="list-style-type: none"> • Electrovalve YV19 or YV2 defective • Coil defective • Electronic module U1 defective • Wiring harness defective • Printed circuit defective • Basket rotation swtich SA4 defective 	Fiche DP027
No jib movement (up and / or down) from the platform (or turntable) control station	<ul style="list-style-type: none"> • Electrovalve YV18 or YV2 defective • Coil defective • Electronic module U1 defective • Wiring harness defective • Printed circuit defective • Flow limiter defective • Jib switch SA7 or SA6 defective 	Fiche DP028
No telescoping movement (out and/or in) from the platform (or turntable) control station	<ul style="list-style-type: none"> • Electrovalve YV14 or YV2 defective • Coil defective • Electronic module U1 defective • Wiring harness defective • Printed circuit defective • Telescoping switch SA9 or SA8 defective • Pressure limiter defective 	Fiche DP067
No boom lifting movement (up and/or down) from the platform (or turntable) control station	<ul style="list-style-type: none"> • Electrovalve YV3 defective • Electronic module U1 defective • Wiring harness defective • Printed circuit defective • Lifting switch SA13 defective • Lifting manipulator SM31 defective 	Fiche DP068
No arm lifting movement (up and/or down) from the platform (or turntable) control station	<ul style="list-style-type: none"> • Electrovalve YV4 defective • Electronic module U1 defective • Wiring harness defective • Printed circuit defective • Lifting switch SA14 defective • Lifting manipulator SM2 defective 	Fiche DP031

14.1.3 -Travel system

ANOMALY	PROBABLE CAUSE	SOLUTION
No machine travel movement	<ul style="list-style-type: none"> • Connectors disconnected • Manipulator HM4 defective • Wiring harness defective • Electronic module U1 defective • Coils of electrovalve YV6 or YV7 defective • Electrovalves YV6 or YV7 defectives 	Fiche DP032
Only travel micro-speed remains available on the machine, regardless of the speed selected	<ul style="list-style-type: none"> • Machine unfolded • Contactors SQ2, SQ3, SQ4 incorrectly set or defective • Wiring harness defective • Electronic module U1 defective • Printed circuit defective 	Fiche DP071
Machine travel speed does not correspond to the selector	<ul style="list-style-type: none"> • Electrovalve YV8, YV10 or YV12 defective • Coil of electrovalve YV8, YV10 or YV12 defective • Wiring harness defective • Printed circuit defective • Speed selector SA11 defective • Electronic module U1 defective 	Fiche DP069
Sudden stop of travel during a platform lifting operation	<ul style="list-style-type: none"> • Contactors SQ3, SQ4, SQ2 incorrectly set or defective • Wiring harness defective • Electronic module U1 defective 	Fiche DP070
No differential blocking during action on switch SA3	<ul style="list-style-type: none"> • Switch SA3 or SA11 defective • Electronic module U1 defective • Wiring harness defective • Contactors SQ3, SQ4, SQ2 incorrectly set or defective • Printed circuit defective • Coils of electrovalves YV9 or YV13 defective • Electrovalves YV9 or YV13 defective 	Fiche DP036
No grip on a drive wheel	<ul style="list-style-type: none"> • Insufficient load on one wheel 	<ul style="list-style-type: none"> • Act on the blocking button

14.1.4 -Steering system

ANOMALY	PROBABLE CAUSE	SOLUTION
No steering movement (right and/or left) on the front axle	<ul style="list-style-type: none"> • Electrovalve YV22 or YV2 defective • Coil defective • Electronic module U1 defective • Wiring harness defective • Printed circuit defective • Switch SA12 defective 	Fiche DP037
No steering movement (right and/or left) on the rear axle	<ul style="list-style-type: none"> • Electrovalve YV21 or YV2 defective • Coil defective • Electronic module U1 defective • Wiring harness defective • Printed circuit defective • Travel switch SM4 defective 	Fiche DP038

14.1.5 -Turntable rotation system

ANOMALY	PROBABLE CAUSE	SOLUTION
No turntable rotation movement (right and/or left) from the platform (or turntable) control station	<ul style="list-style-type: none"> • Electrovalve YV5 defective • Electronic module U1 defective • Wiring harness defective • Printed circuit defective • Rotation switch SA15 defective • Rotation manipulator SM31 defective 	Fiche DP018
The turntable does not turn	<ul style="list-style-type: none"> • The blocking pin has not been removed from the chassis 	<ul style="list-style-type: none"> • Remove the pin

NB: In the turntable box, LEDs indicate the state of each output so that you can check if an output is activated.

14.2 - BREAKDOWN DETECTION FLOW CHART

Sheet DP016	BREAKDOWN DETECTION FLOW CHART	Folio 1/3
	THE MOTOR DOES NOT START, THE STARTER IS NOT ACTIVATED	

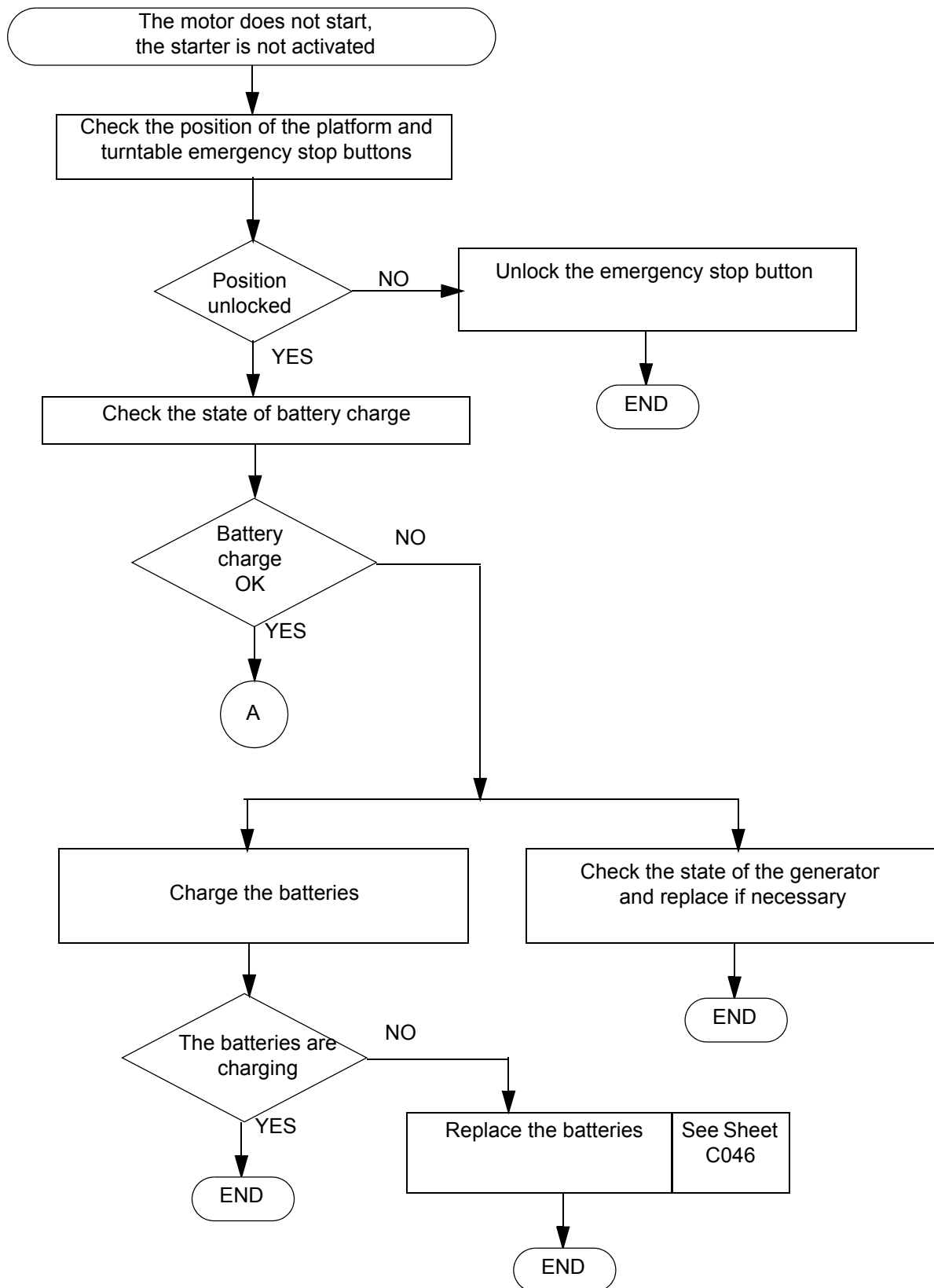

Sheet DP016	BREAKDOWN DETECTION FLOW CHART	Folio 2/3
	THE MOTOR DOES NOT START, THE STARTER IS NOT ACTIVATED	

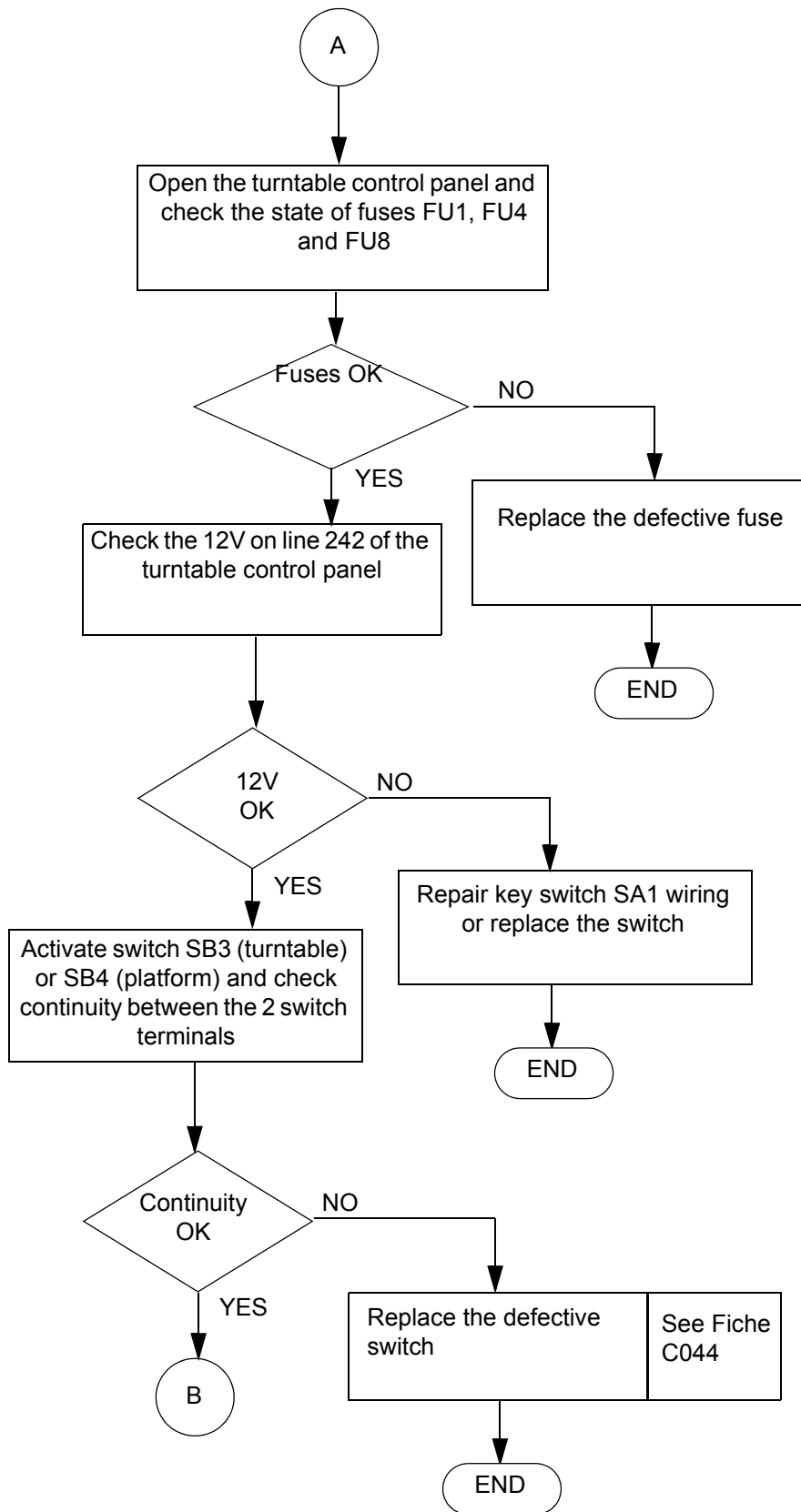

Sheet DP016	BREAKDOWN DETECTION FLOW CHART	Folio 3/3
	THE MOTOR DOES NOT START, THE STARTER IS NOT ACTIVATED	

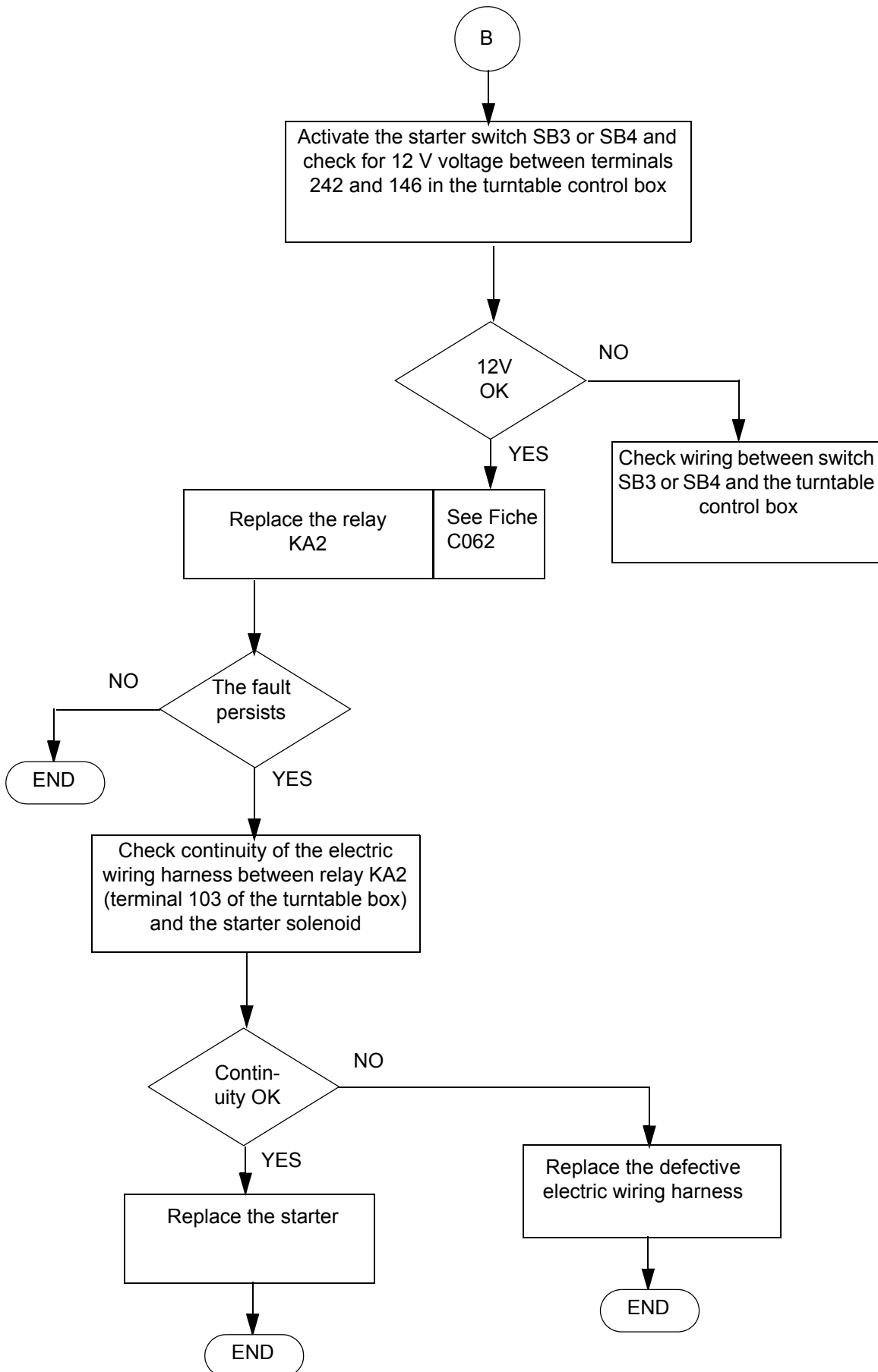

Sheet DP017	BREAKDOWN DETECTION FLOW CHART	Folio 1/1
	THE MOTOR STARTS THEN STOPS AFTER 5 sec	

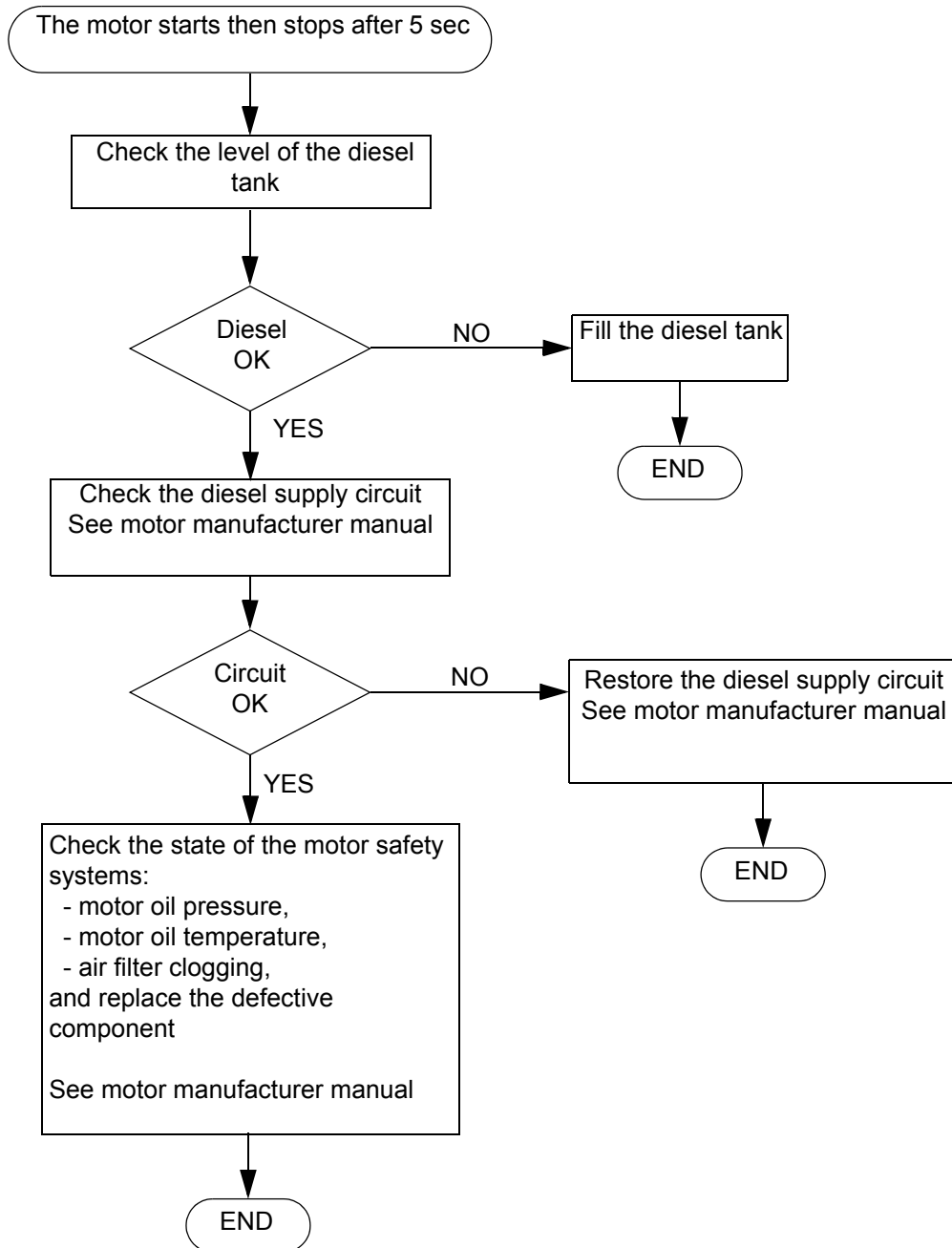

Sheet DP018	BREAKDOWN DETECTION FLOW CHART	Folio 1/3
	NO TURNTABLE ROTATION MOVEMENT (RIGHT AND / OR LEFT) FROM THE PLATFORM (OR TURNTABLE) CONTROL PANEL	

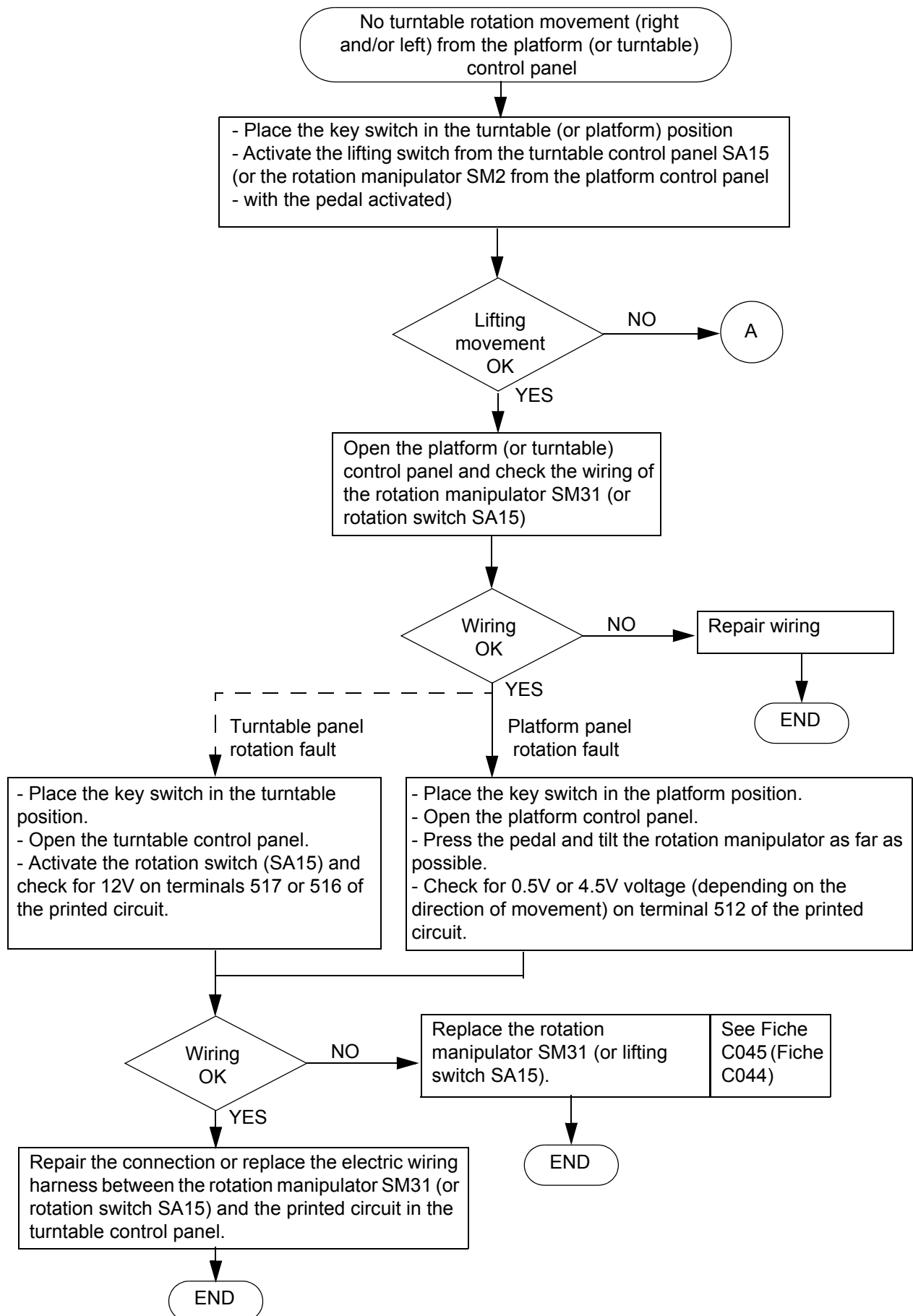

Sheet DP018	BREAKDOWN DETECTION FLOW CHART	Folio 2/3
	NO TURNTABLE ROTATION MOVEMENT (RIGHT AND / OR LEFT) FROM THE PLATFORM (OR TURNTABLE) CONTROL PANEL	

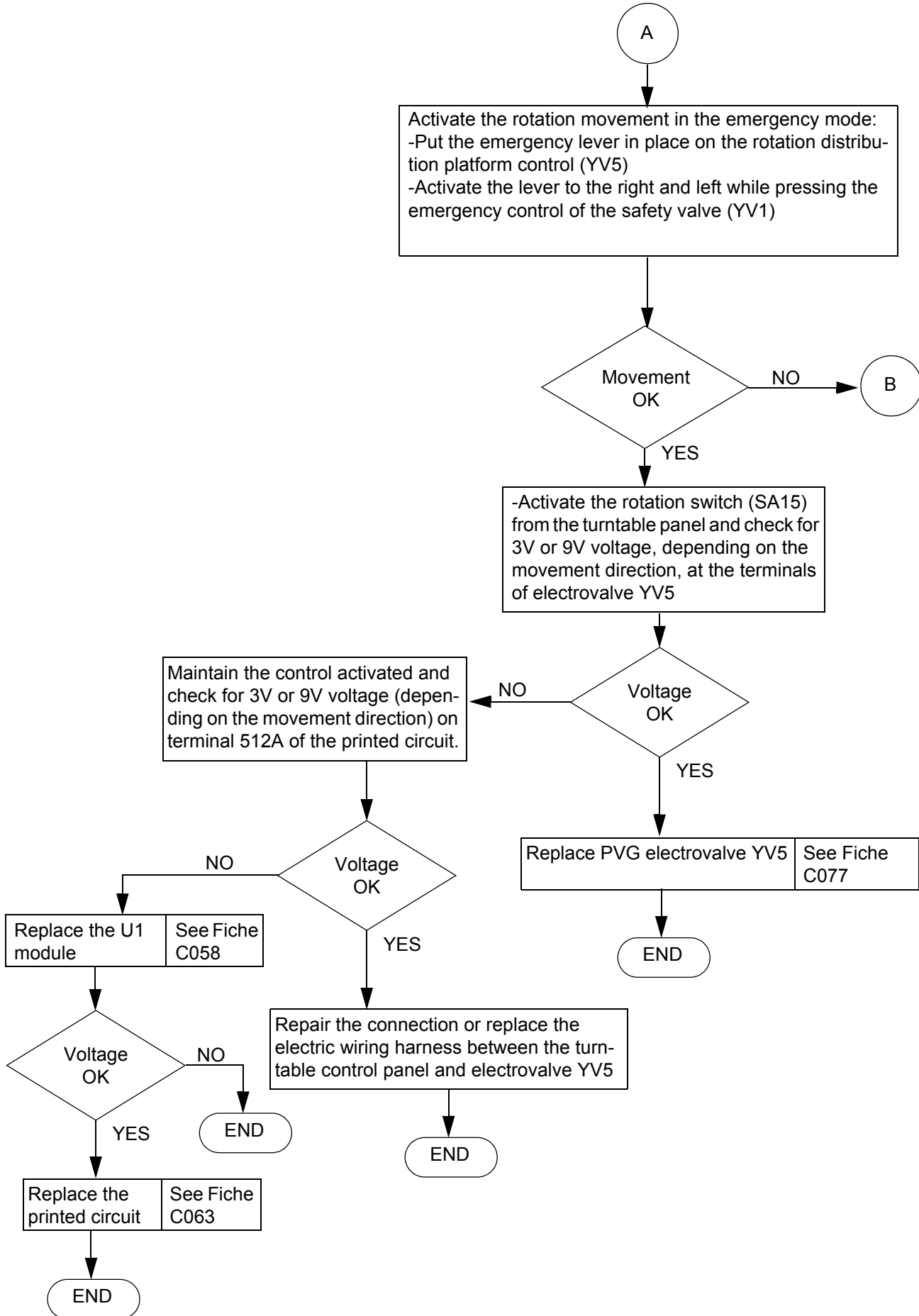

Sheet DP018	BREAKDOWN DETECTION FLOW CHART	Folio 3/3
	NO TURNTABLE ROTATION MOVEMENT (RIGHT AND / OR LEFT) FROM THE PLATFORM (OR TURNTABLE) CONTROL PANEL	

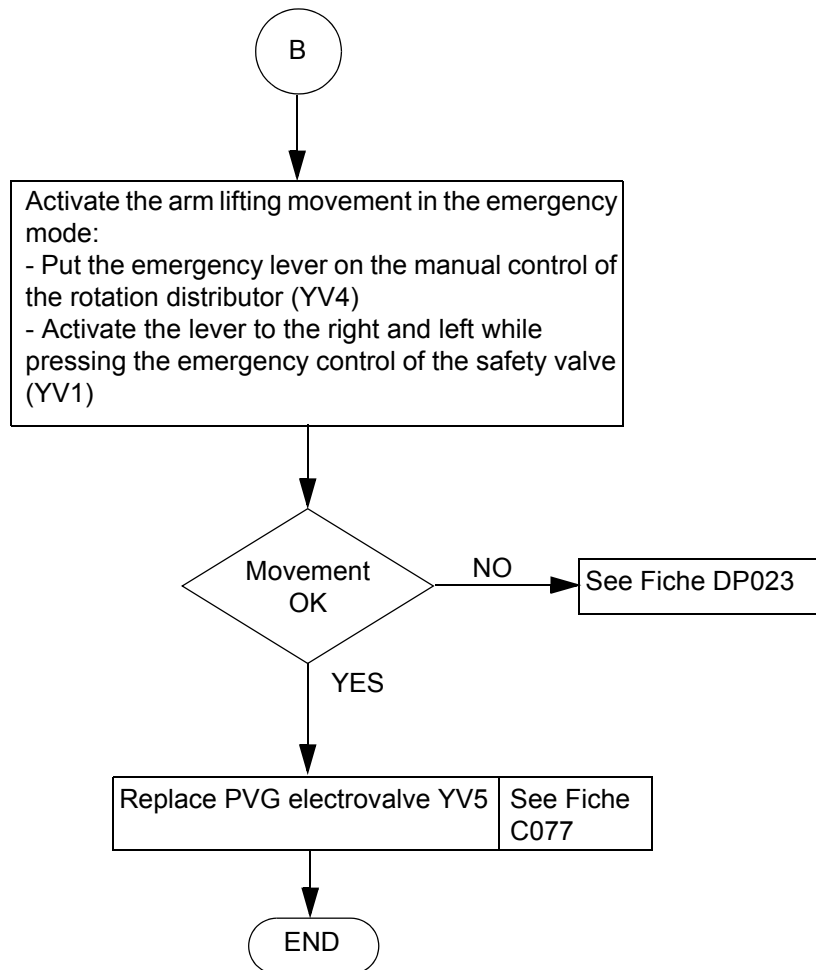

Sheet DP019	BREAKDOWN DETECTION FLOW CHART	Folio 1/2
	THE MOTOR DOES NOT START FROM THE PLATFORM PANEL BUT DOES START FROM THE TURNTABLE PANEL	

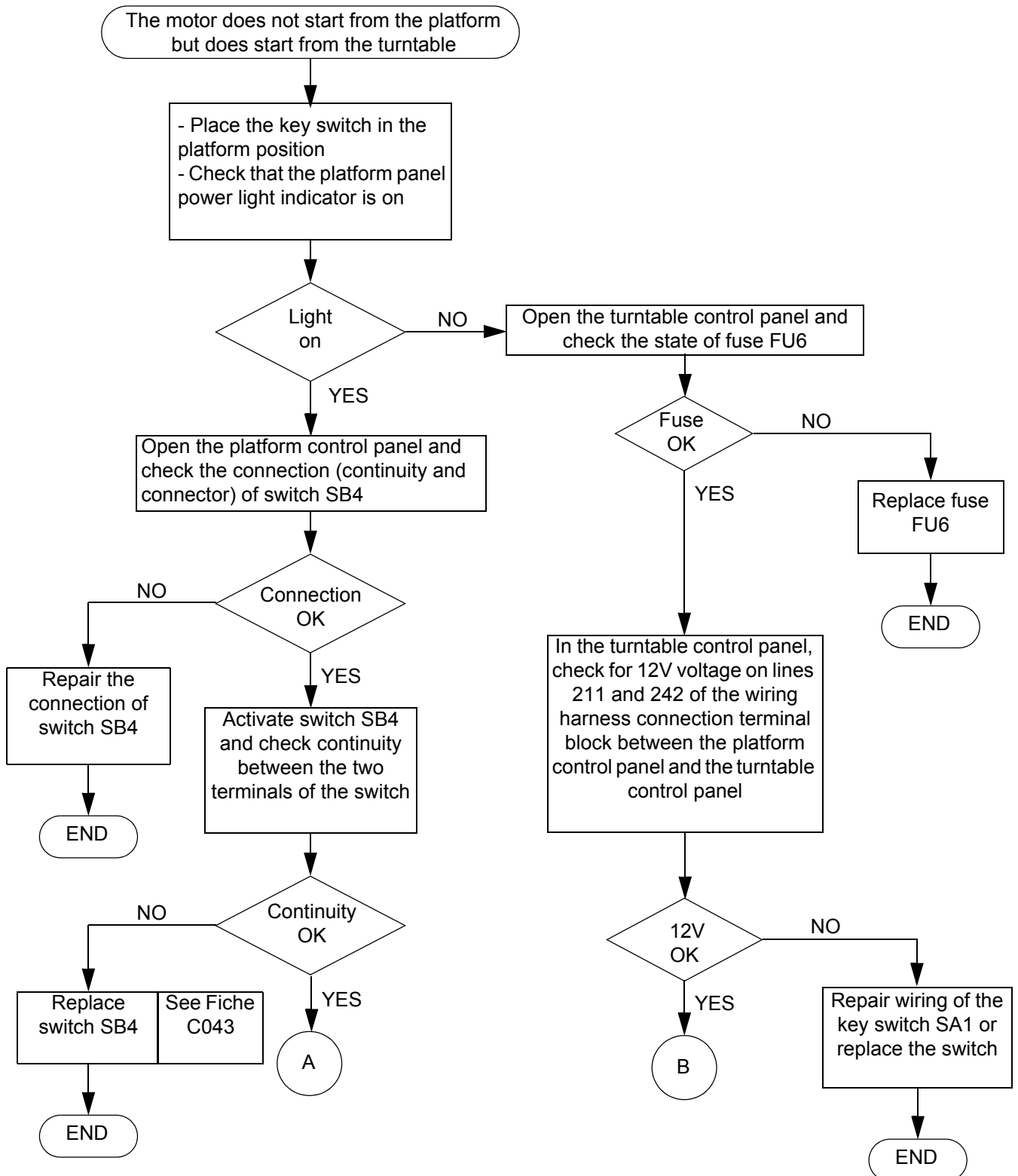

Sheet DP019	BREAKDOWN DETECTION FLOW CHART	Folio 2/2
	THE MOTOR DOES NOT START FROM THE PLATFORM PANEL BUT DOES START FROM THE TURNTABLE PANEL	

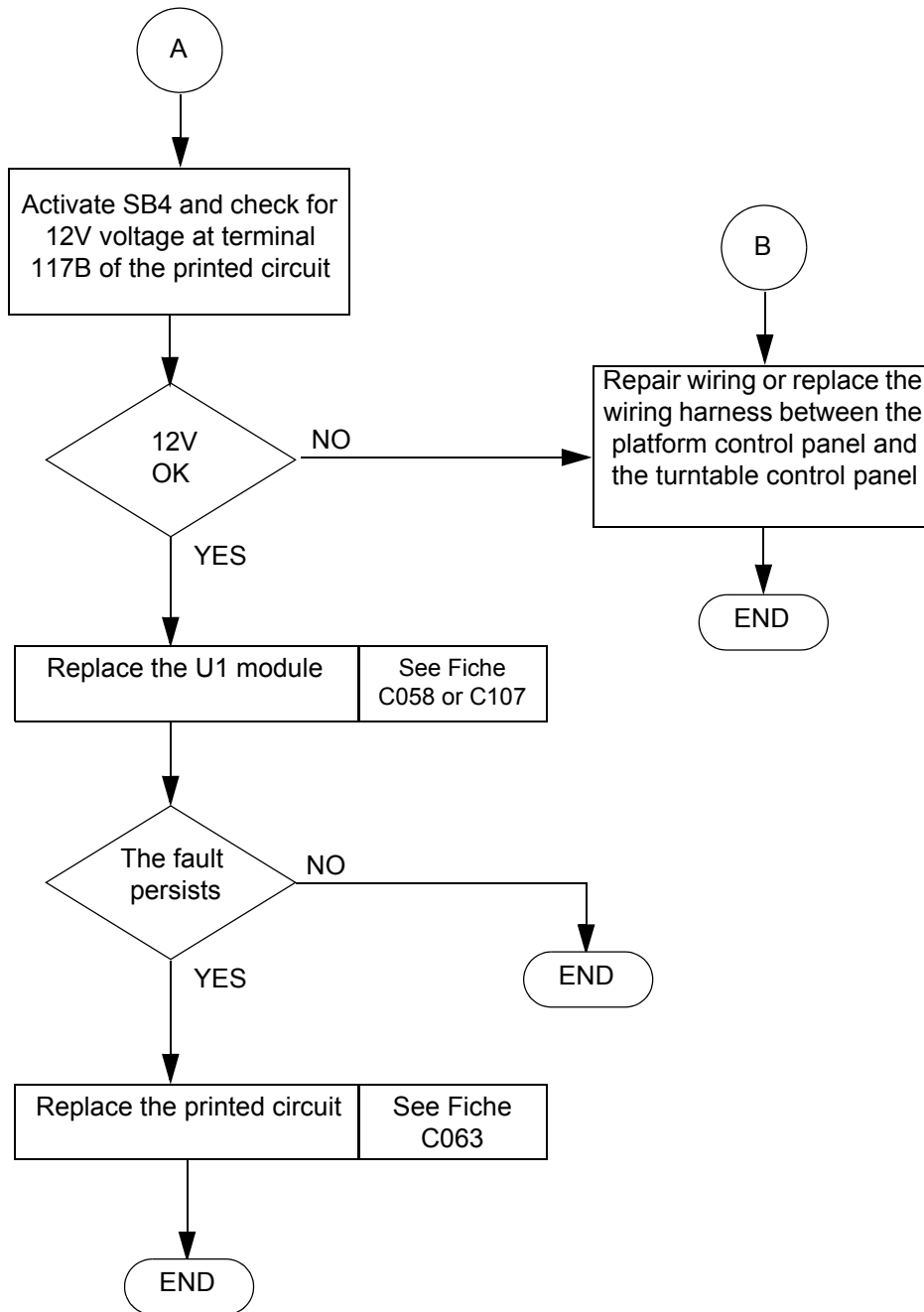

Sheet DP020	BREAKDOWN DETECTION FLOW CHART	Folio 1/1
	THE MOTOR DOES NOT START FROM THE TURNTABLE CONTROL PANEL BUT DOES START FROM THE PLATFORM CONTROL PANEL	

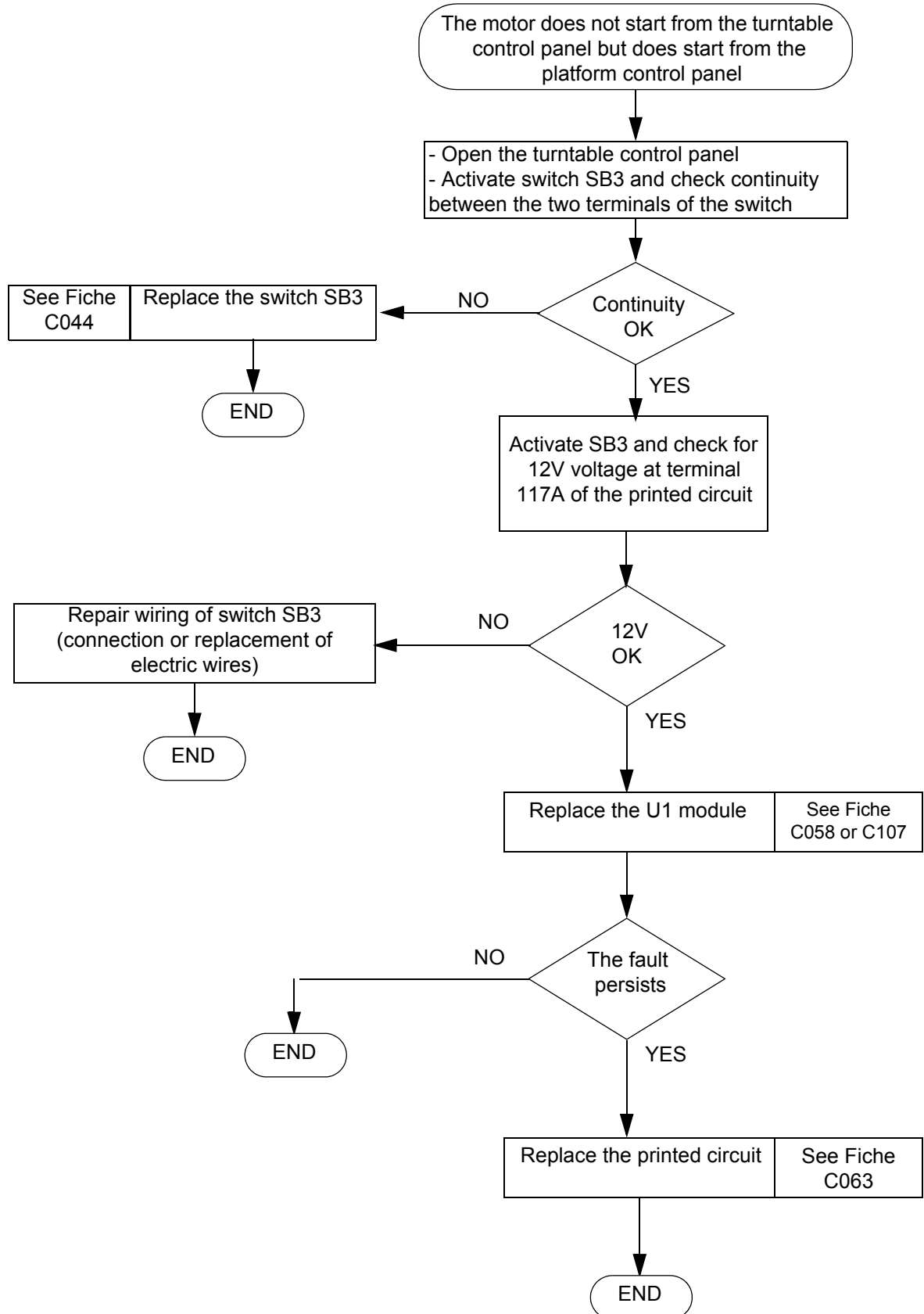

Sheet DP021	BREAKDOWN DETECTION FLOW CHART	Folio 1/1
	MOTOR ACCELERATION FOR ANY MOVEMENT CONTROLLED FROM THE PLATFORM (ACCELERATION, TRAVEL, LIFTING, TURNTABLE ROTATION, TELESCOPE)	

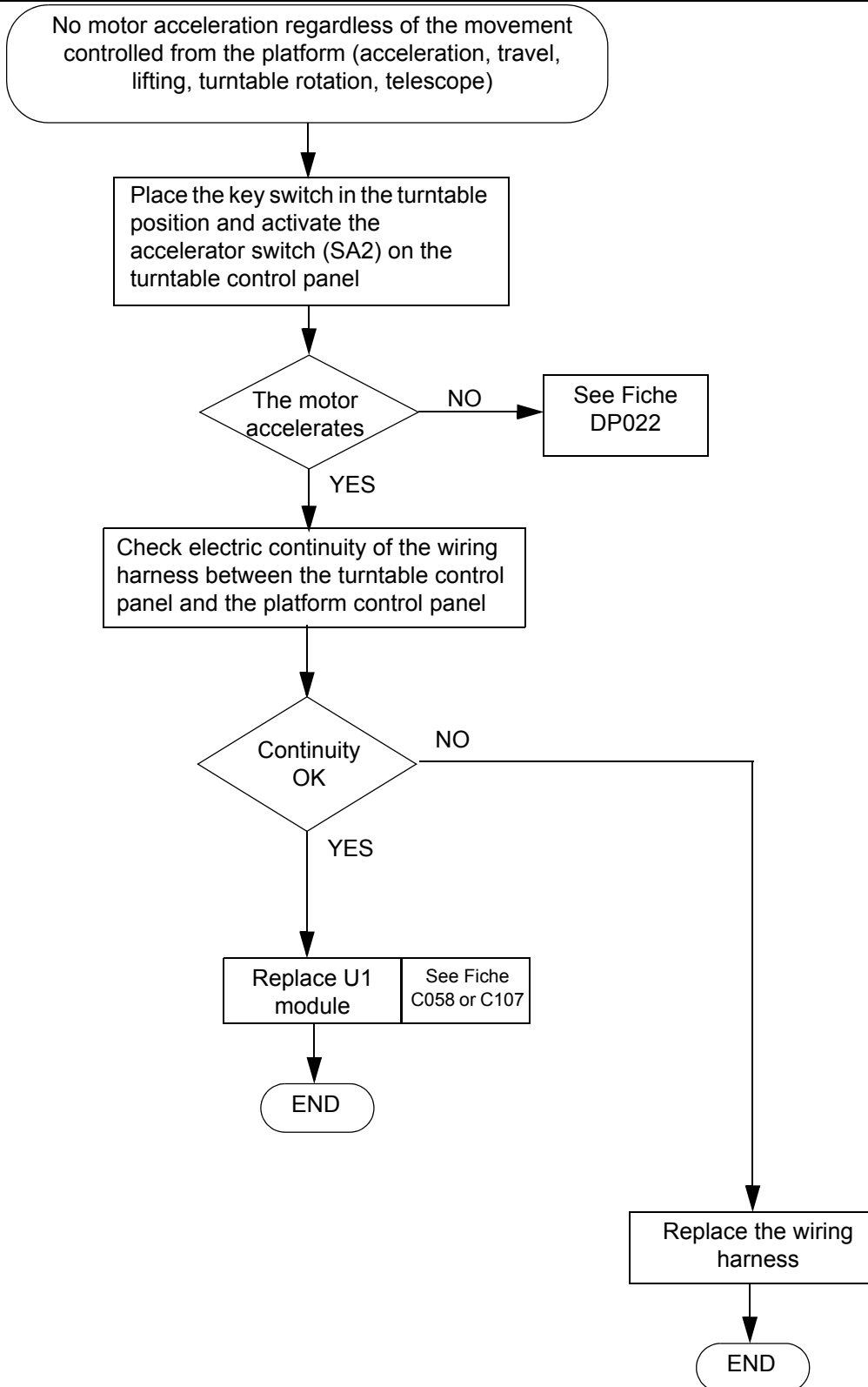

Sheet DP022	BREAKDOWN DETECTION FLOW CHART	Folio 1/2
	NO MOTOR ACCELERATION ON ACTIVATING THE ACCELERATOR SWITCH SA2 FROM THE TURNTABLE CONTROL PANEL	

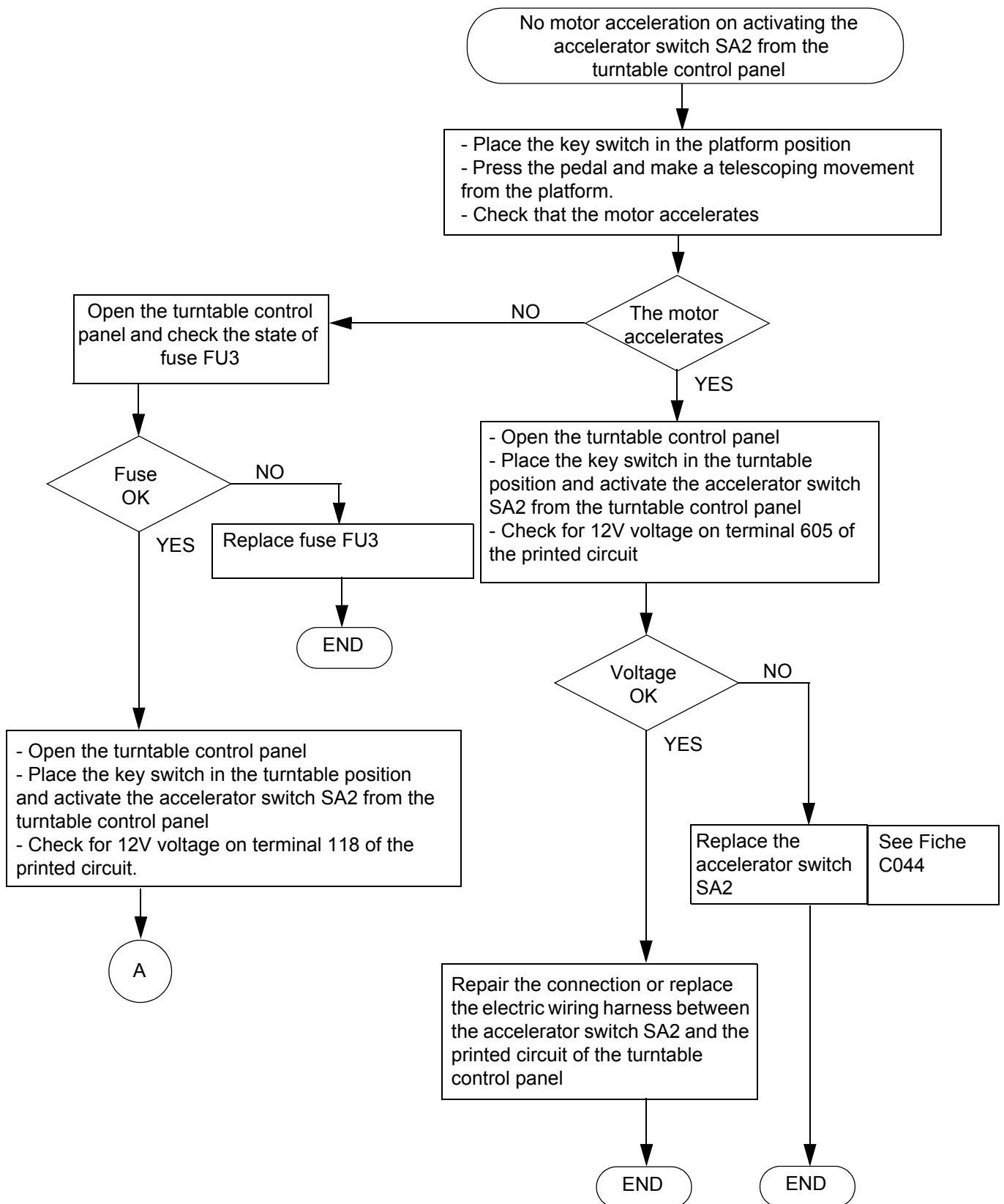

Sheet DP022	BREAKDOWN DETECTION FLOW CHART	Folio 2/2
	NO MOTOR ACCELERATION ON ACTIVATING THE ACCELERATOR SWITCH SA2 FROM THE TURNTABLE CONTROL PANEL	

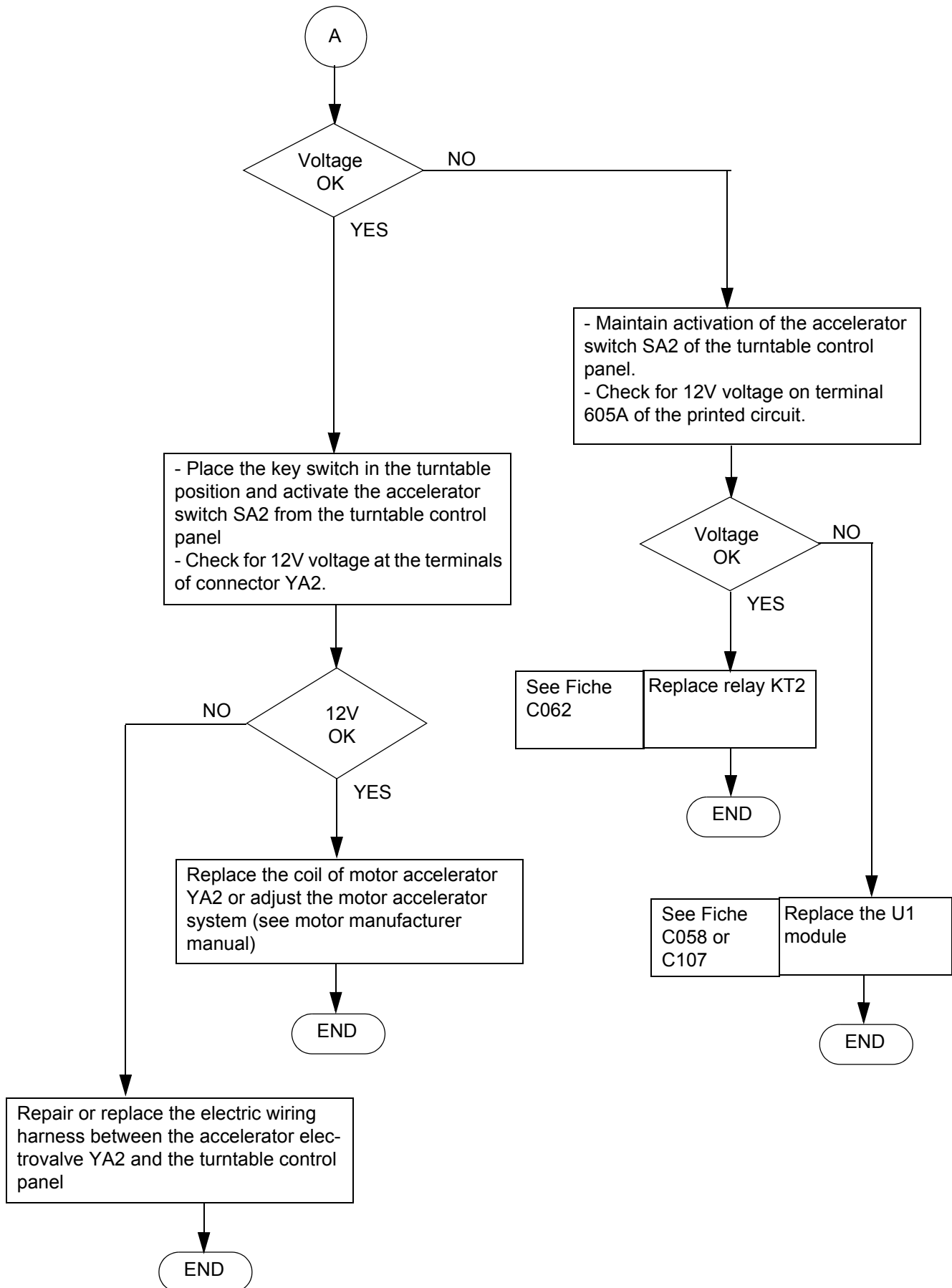

Sheet DP023	BREAKDOWN DETECTION FLOW CHART	Folio 1/5
	NO MOVEMENT AVAILABLE (FROM TURNTABLE OR PLATFORM CONTROL PANELS)	

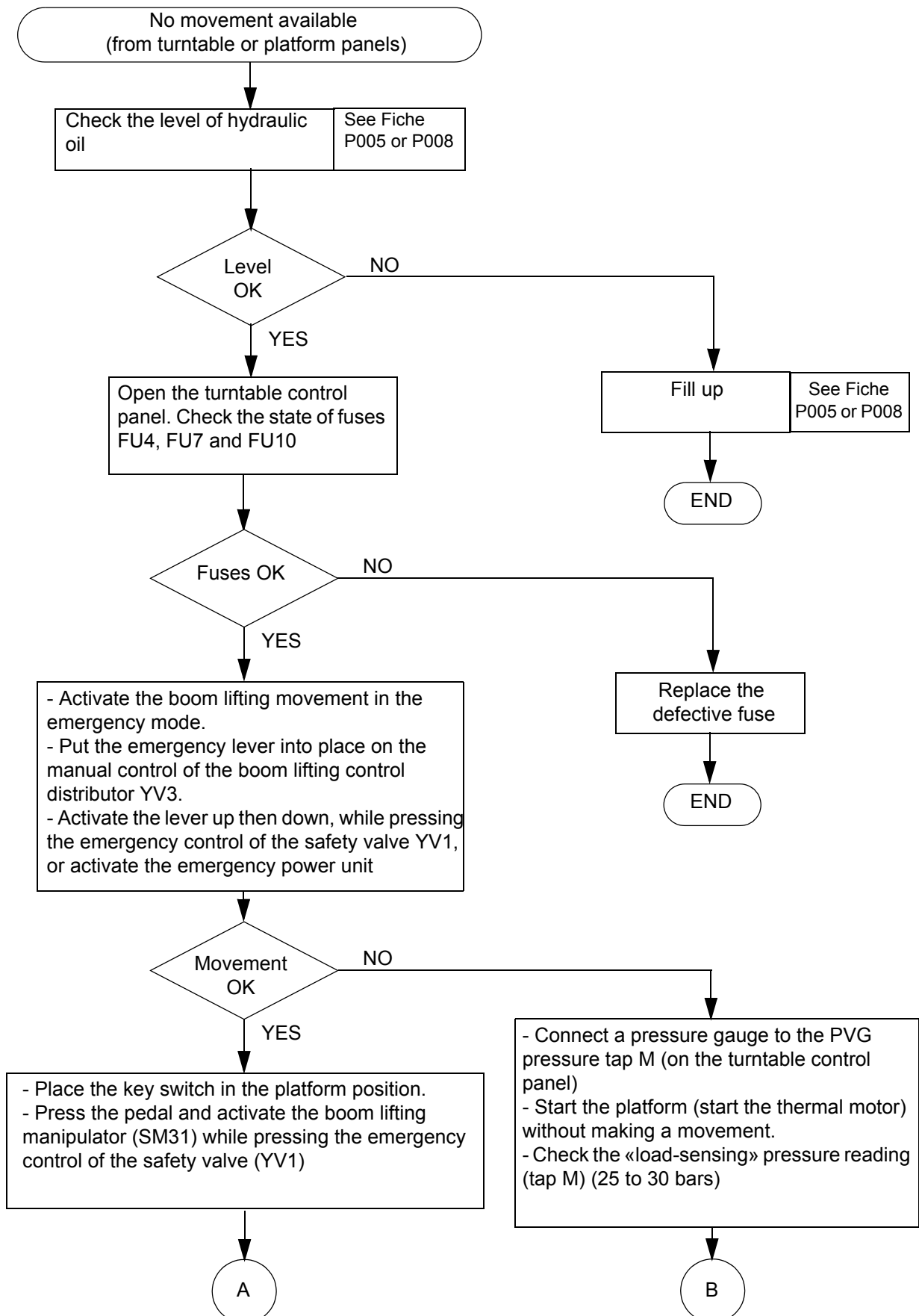

Sheet DP023	BREAKDOWN DETECTION FLOW CHART	Folio 2/5
	NO MOVEMENT AVAILABLE (FROM TURNTABLE OR PLATFORM CONTROL PANELS)	

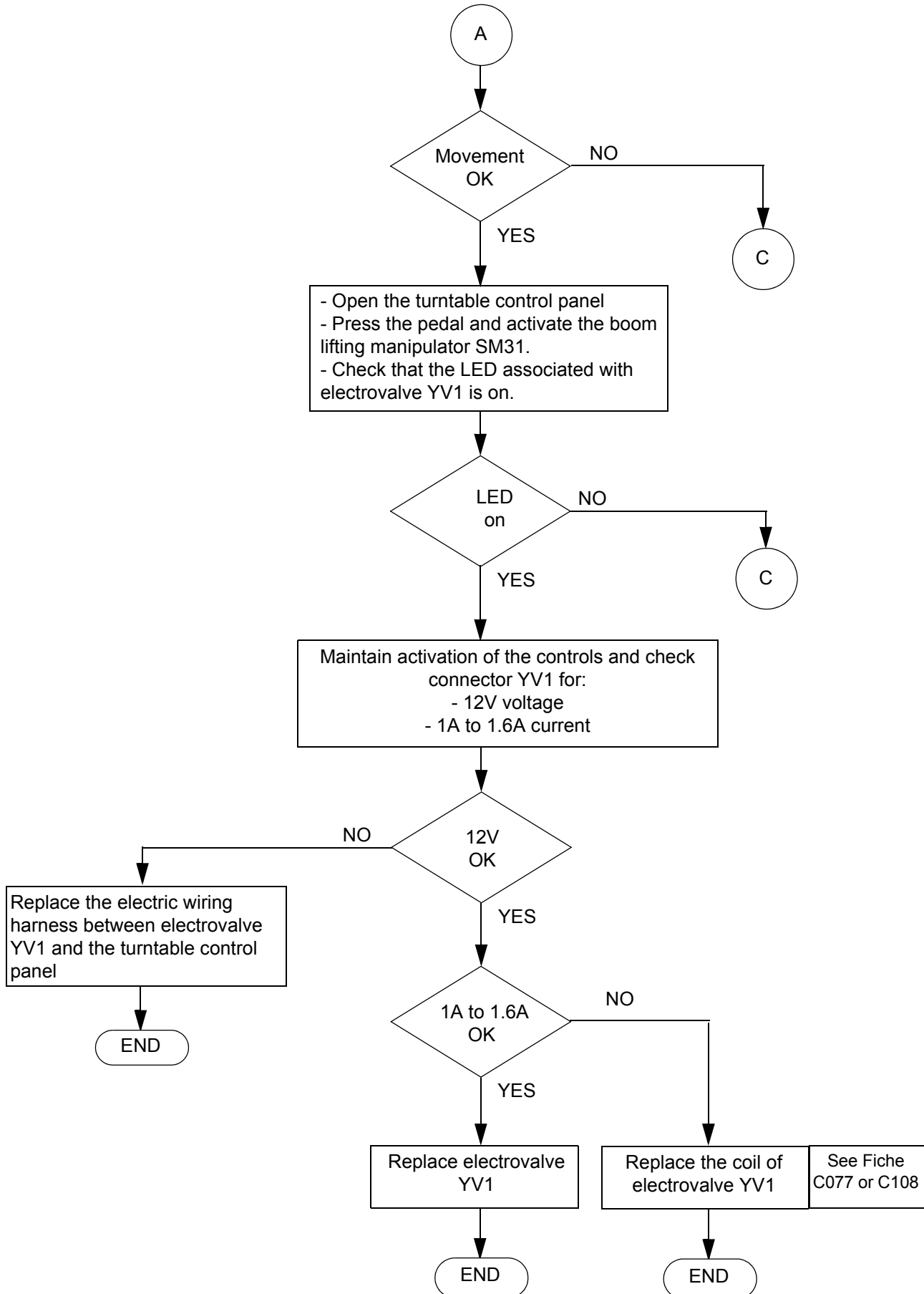

Sheet DP023	BREAKDOWN DETECTION FLOW CHART	Folio 3/5
	NO MOVEMENT AVAILABLE (FROM TURNTABLE OR PLATFORM CONTROL PANELS)	

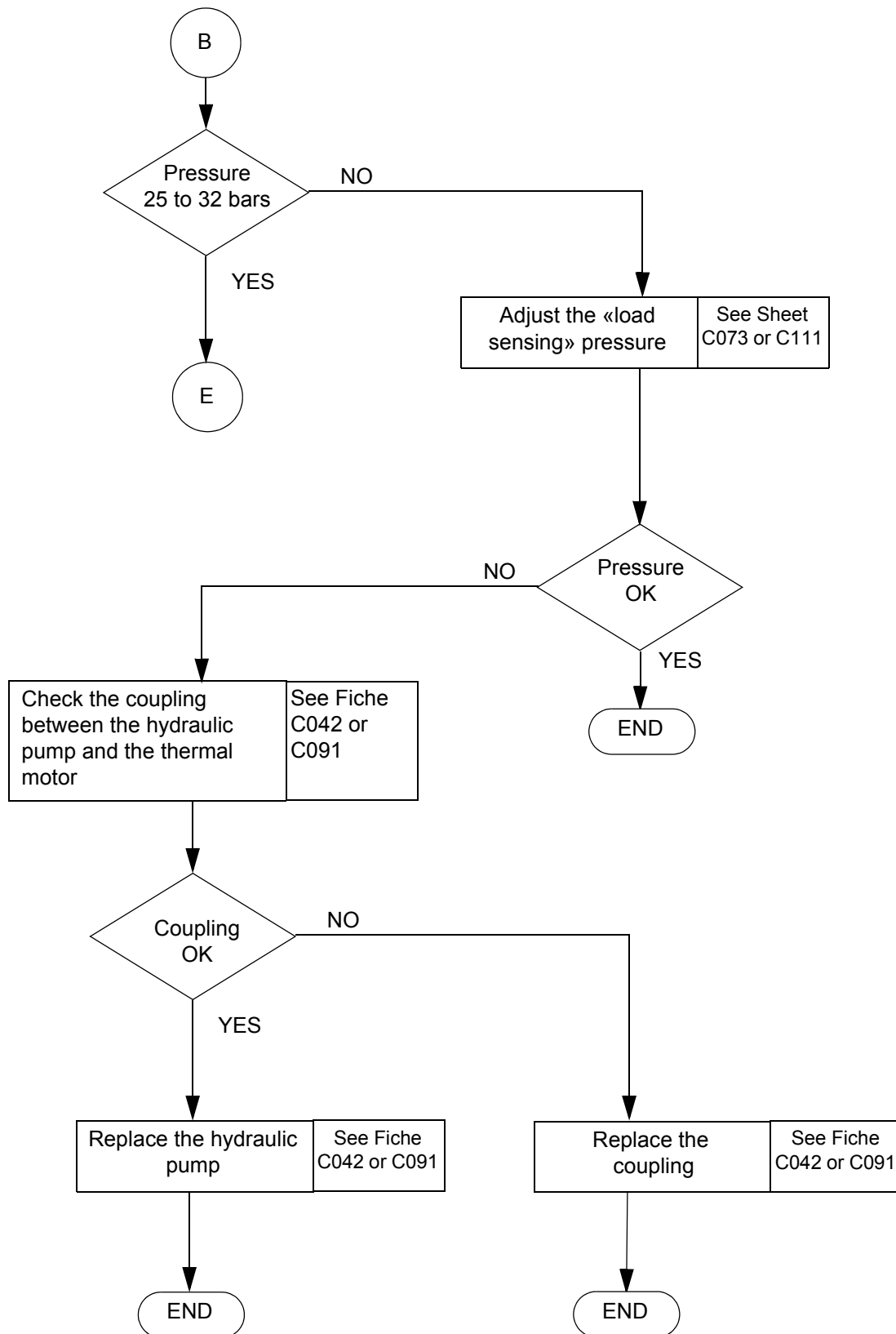

Sheet DP023	BREAKDOWN DETECTION FLOW CHART	Folio 4/5
	NO MOVEMENT AVAILABLE (FROM TURNTABLE OR PLATFORM CONTROL PANELS)	

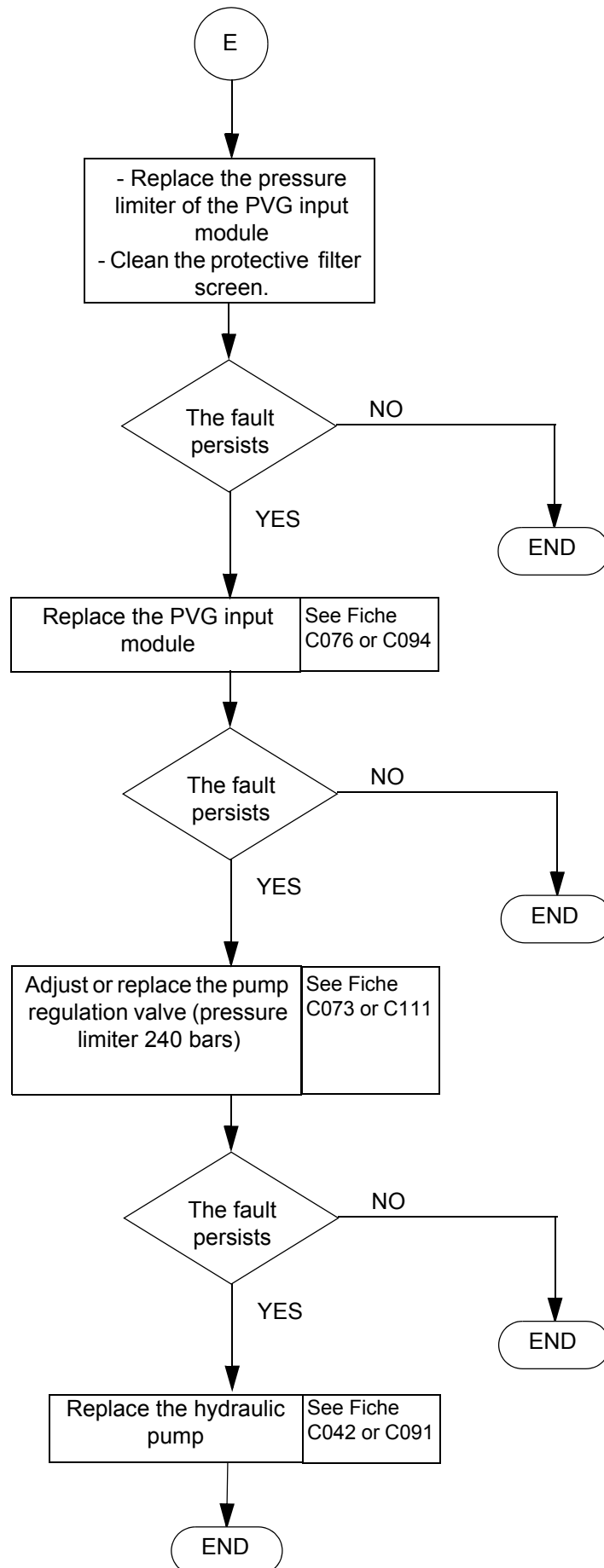

Sheet DP023	BREAKDOWN DETECTION FLOW CHART	Folio 5/5
	NO MOVEMENT AVAILABLE (FROM TURNTABLE OR PLATFORM CONTROL PANELS)	

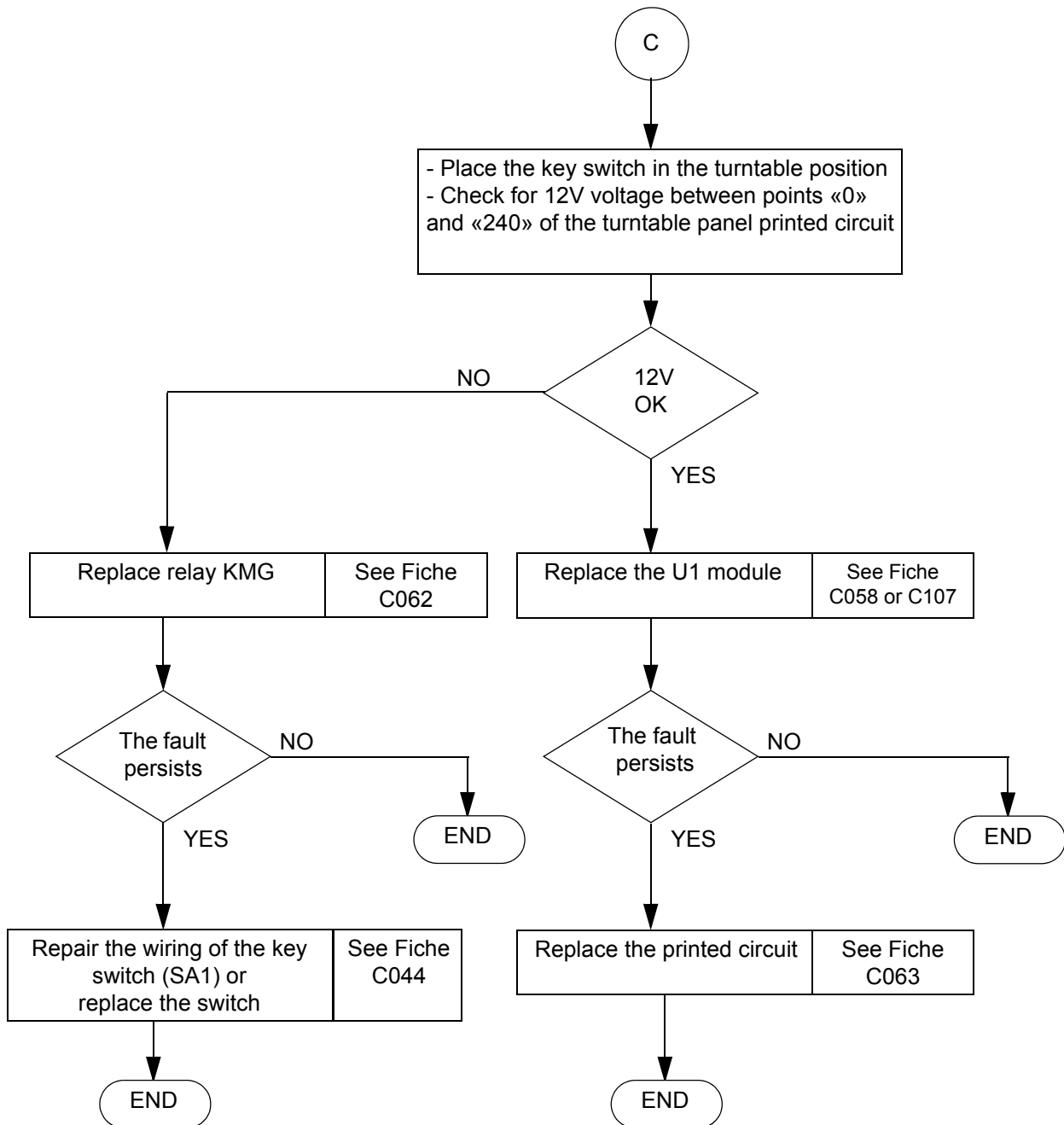

Sheet DP024	BREAKDOWN DETECTION FLOW CHART	Folio 1/2
	NO MOVEMENT AVAILABLE FROM THE PLATFORM CONTROL PANEL	

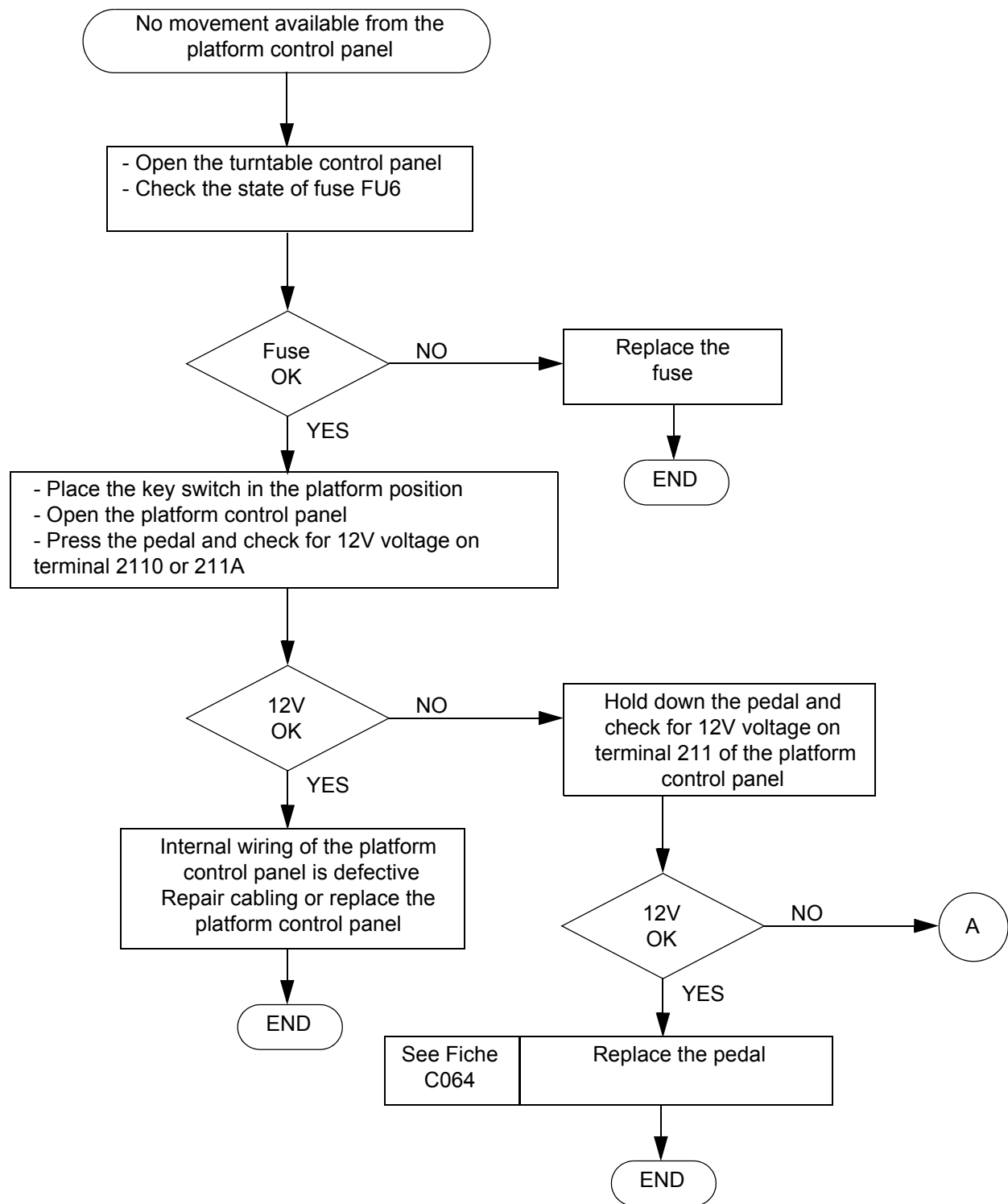

Sheet DP024	BREAKDOWN DETECTION FLOW CHART	Folio 2/2
	NO MOVEMENT AVAILABLE FROM THE PLATFORM CONTROL PANEL	

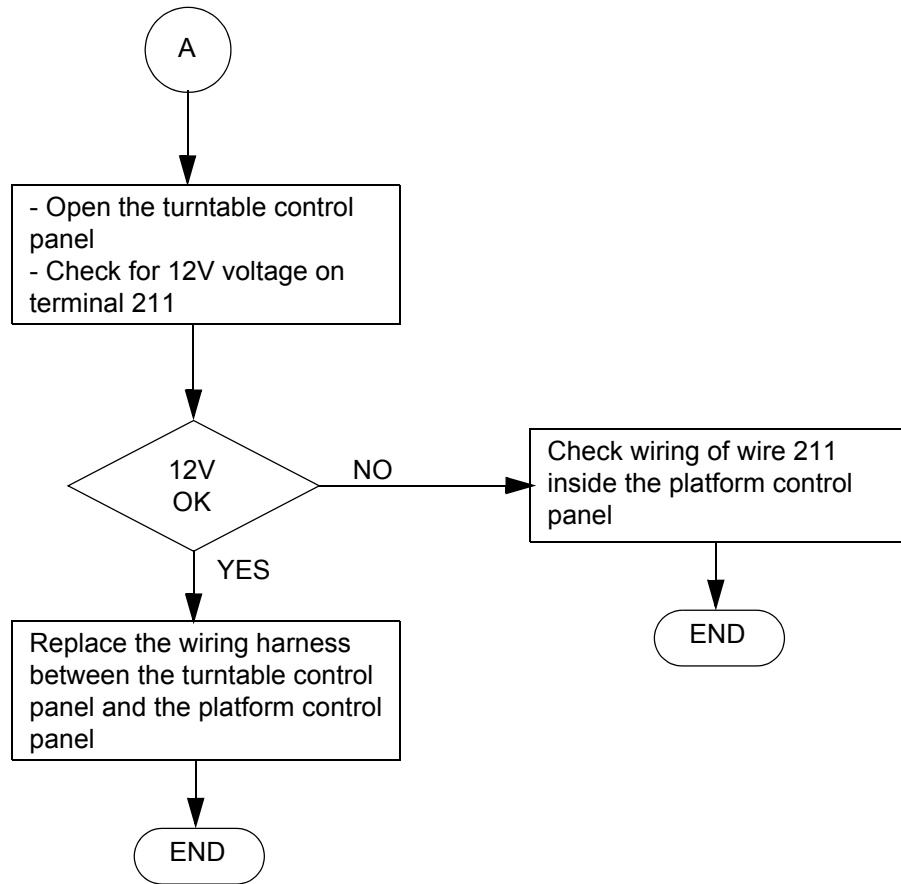

Sheet DP025	BREAKDOWN DETECTION FLOW CHART	Folio 1/2
	NOISY HYDRAULIC PUMP	

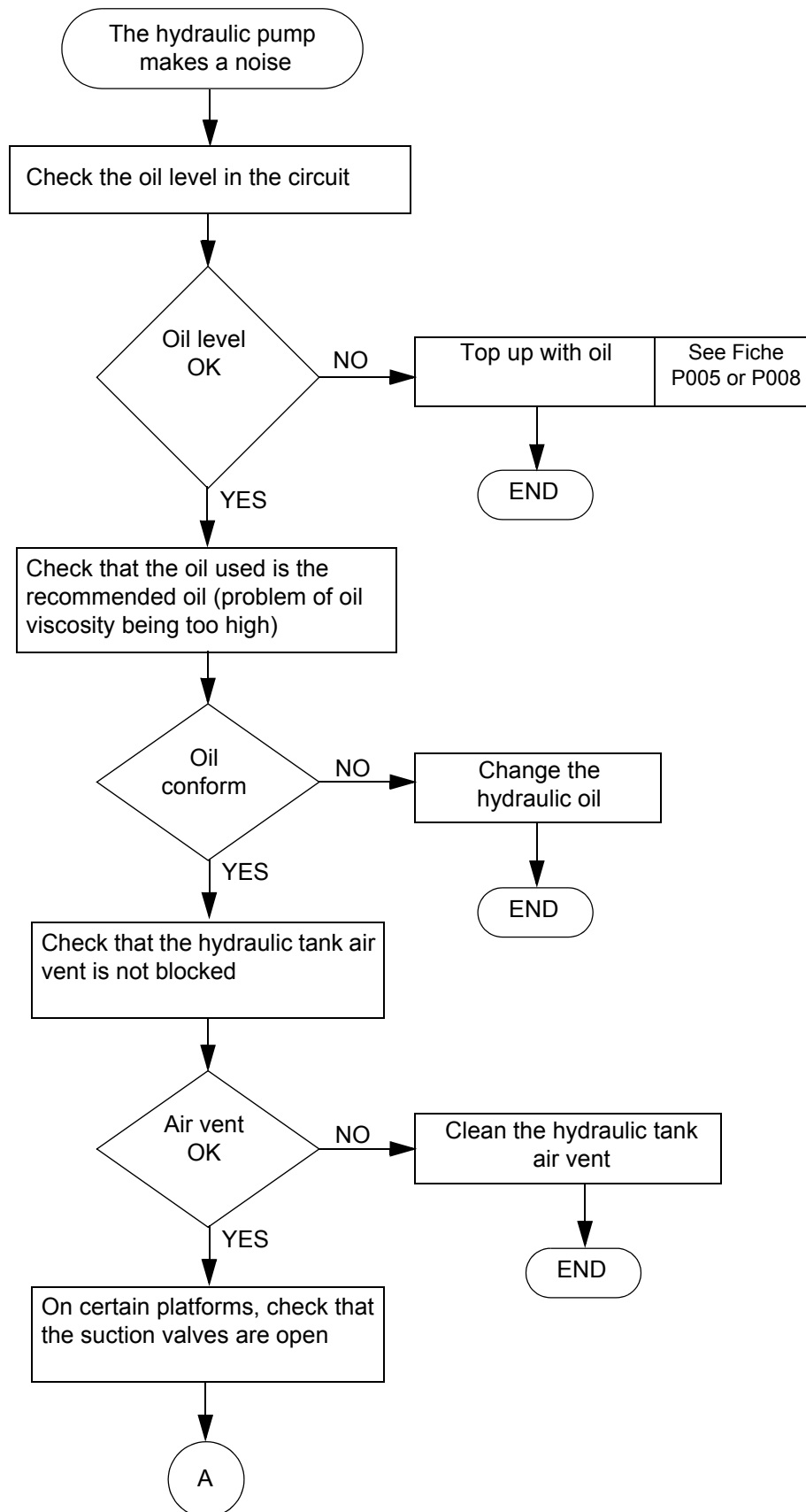

Sheet DP025	BREAKDOWN DETECTION FLOW CHART	Folio 2/2
	NOISY HYDRAULIC PUMP	

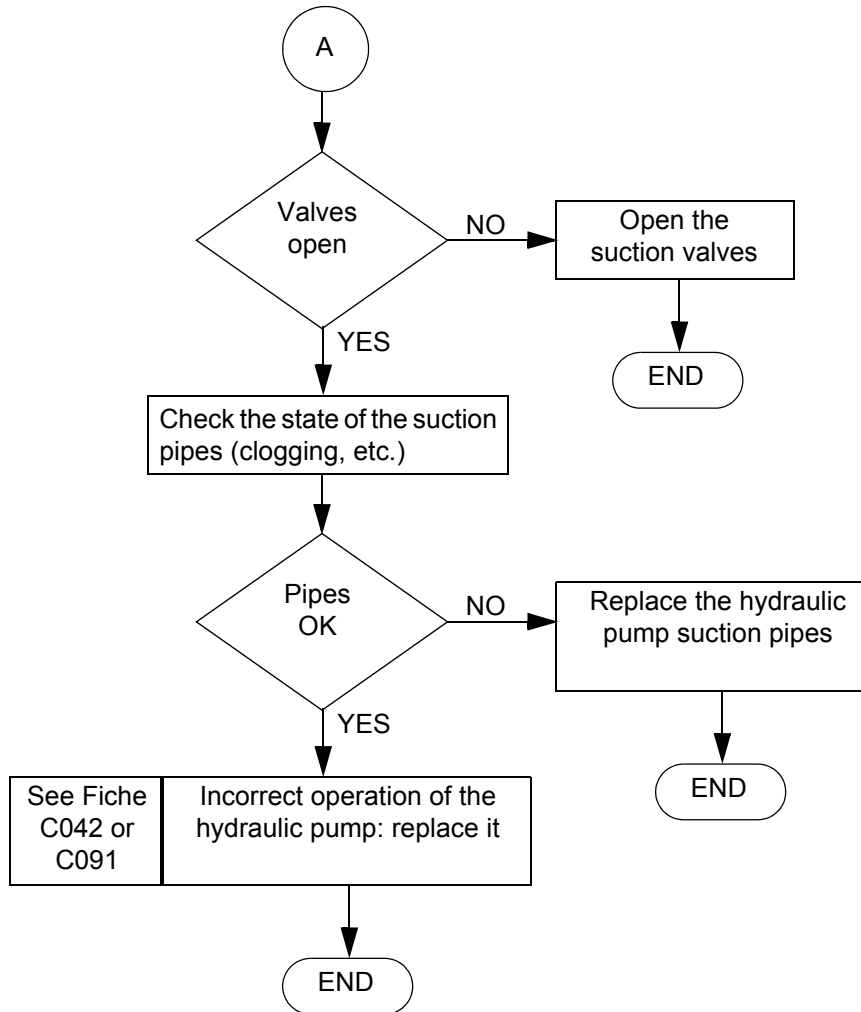

Sheet DP026	BREAKDOWN DETECTION FLOW CHART	Folio 1/5
	NO COMPENSATION MOVEMENT (UP AND / OR DOWN)	

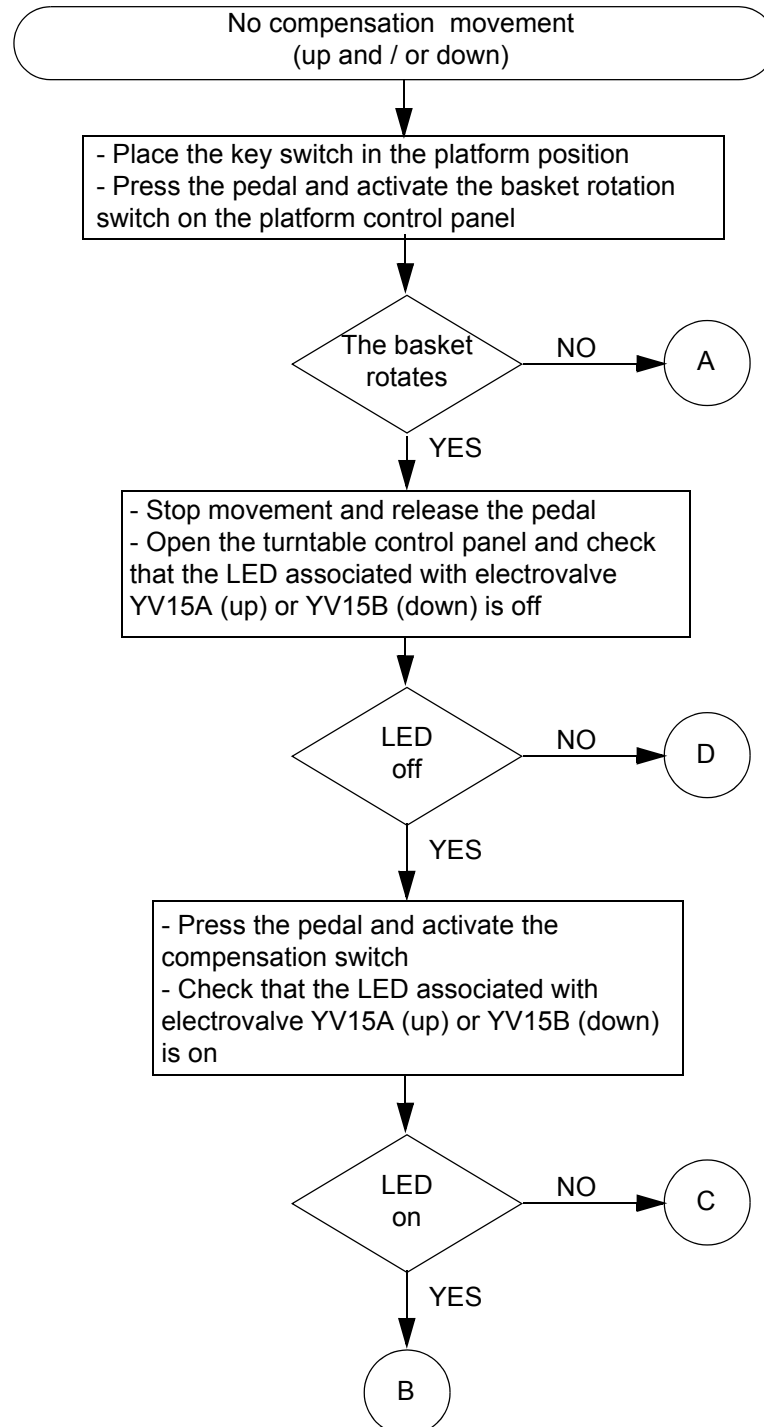

Sheet DP026	BREAKDOWN DETECTION FLOW CHART	Folio 2/5
	NO COMPENSATION MOVEMENT (UP AND / OR DOWN)	

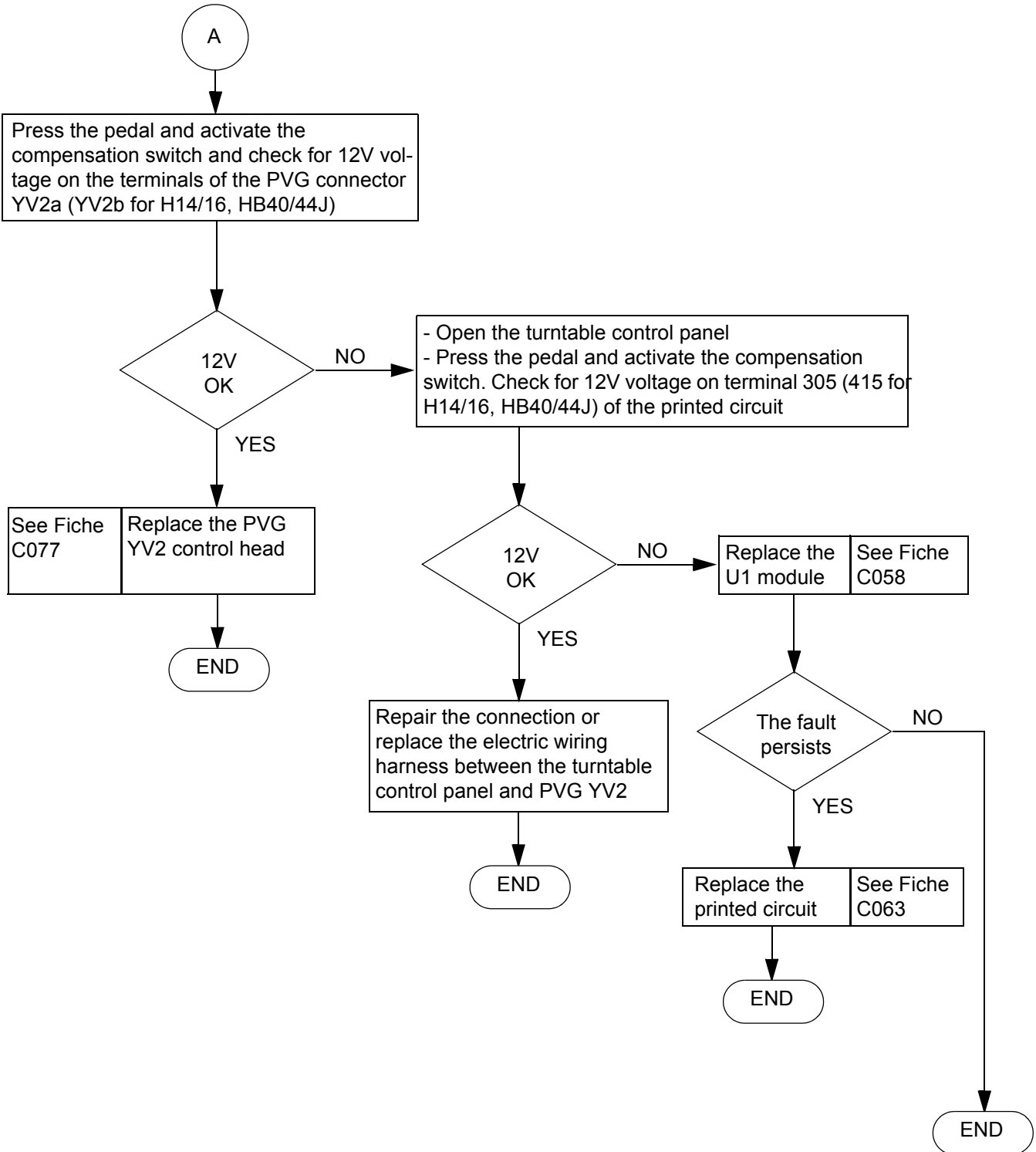

Sheet DP026	BREAKDOWN DETECTION FLOW CHART	Folio 3/5
	NO COMPENSATION MOVEMENT (UP AND / OR DOWN)	

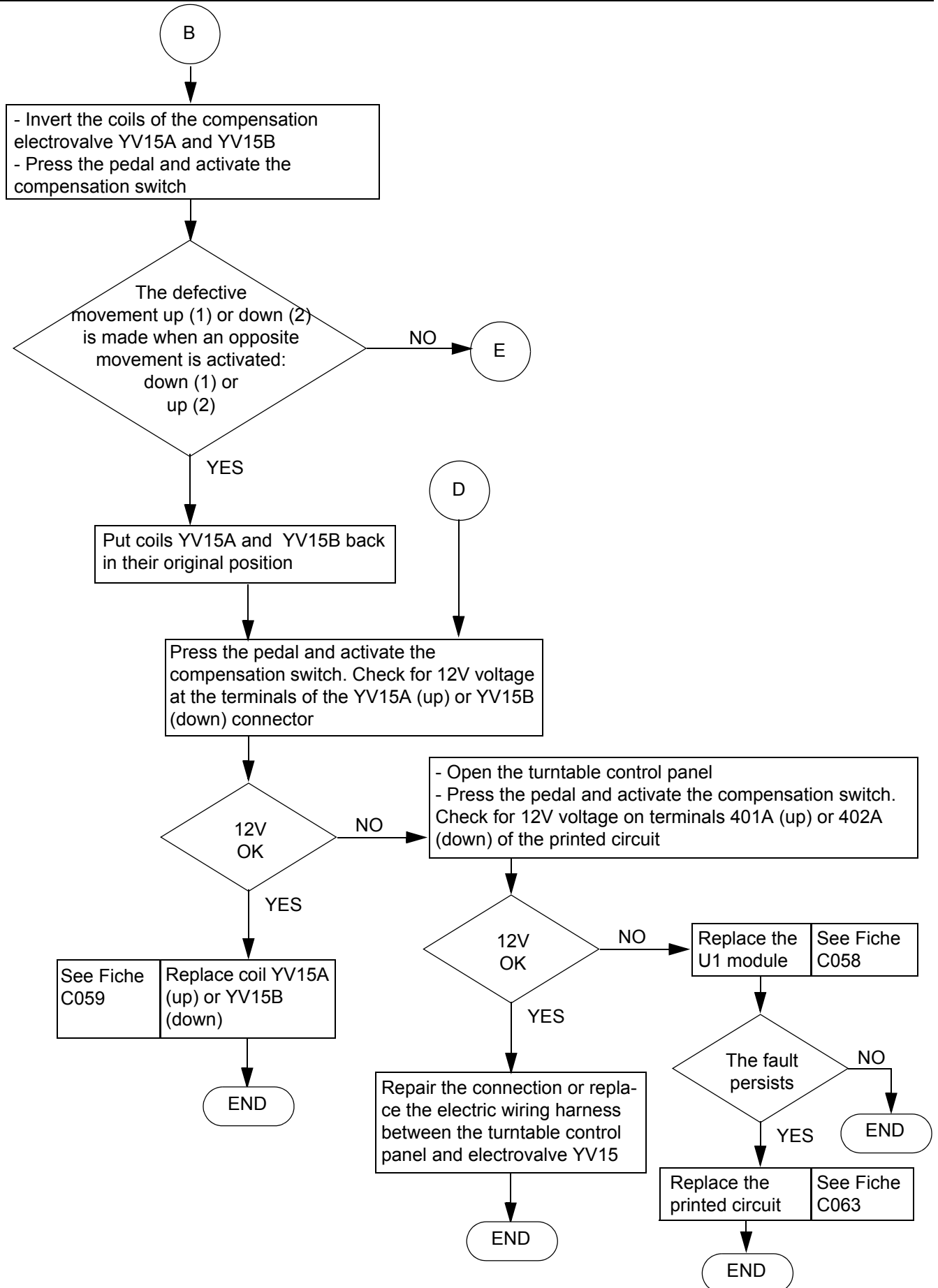

Sheet DP026	BREAKDOWN DETECTION FLOW CHART	Folio 4/5
	NO COMPENSATION MOVEMENT (UP AND / OR DOWN)	

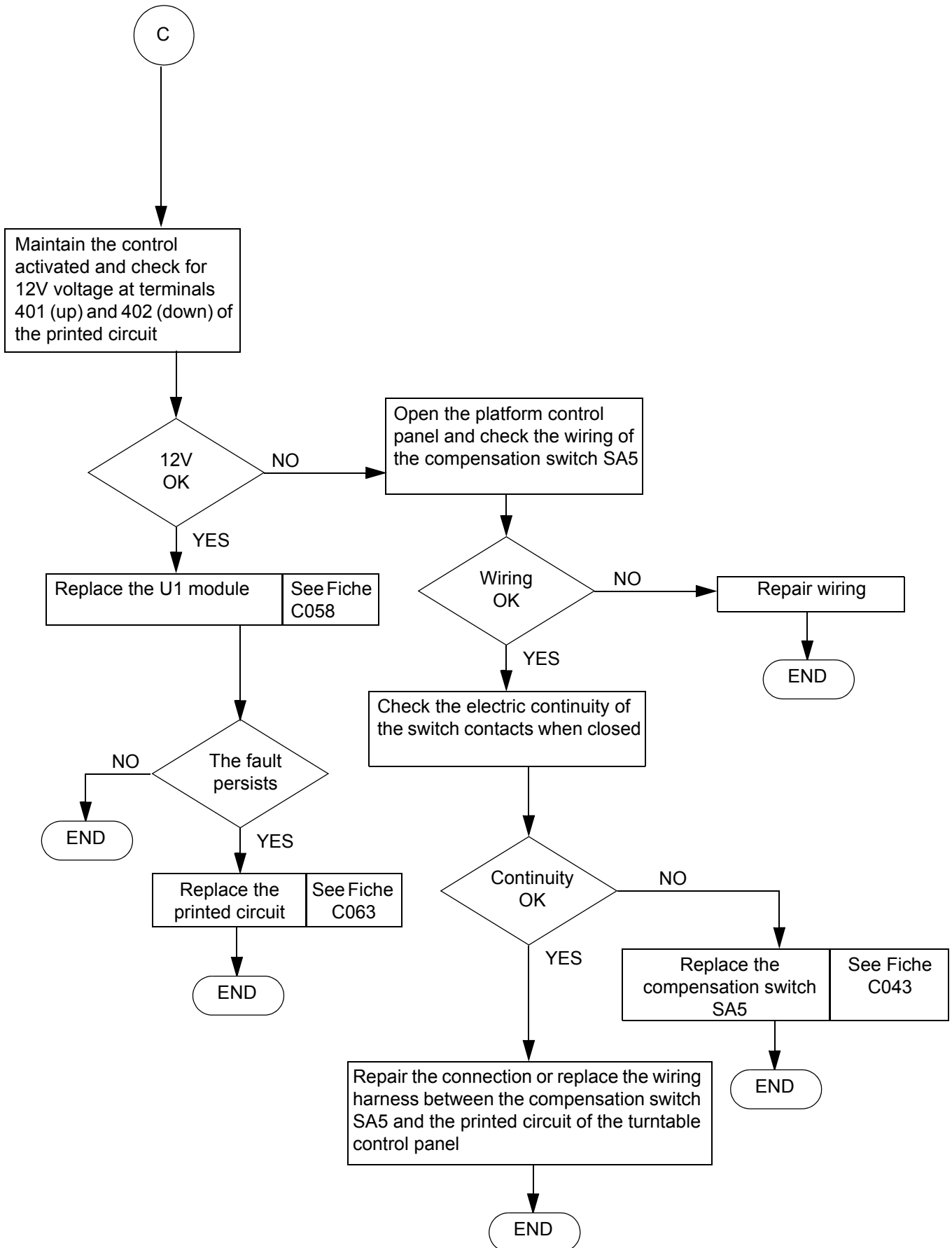

Sheet DP026	BREAKDOWN DETECTION FLOW CHART	Folio 5/5
	NO COMPENSATION MOVEMENT (UP AND / OR DOWN)	

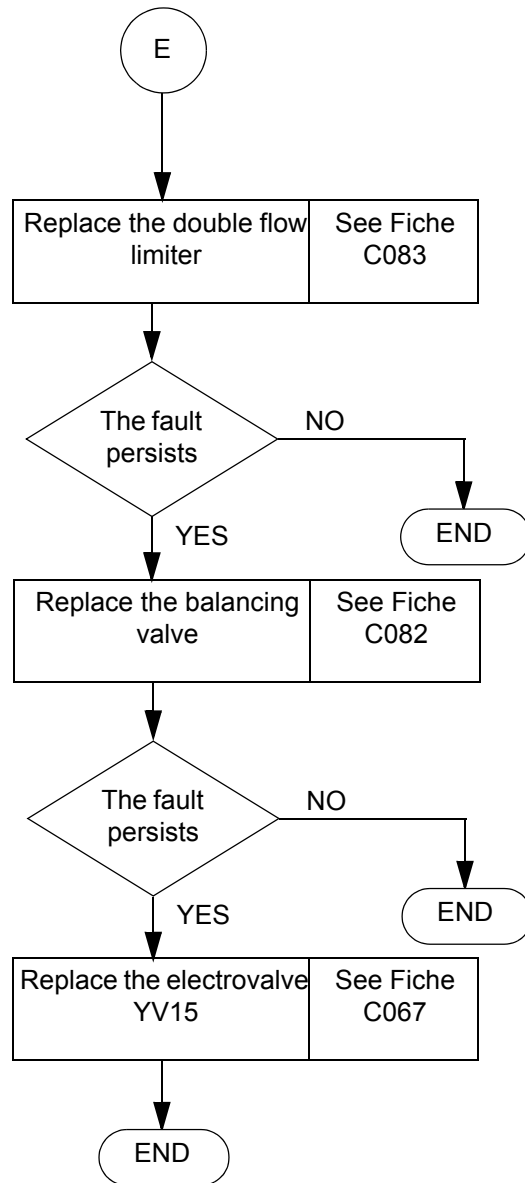

Sheet DP027	BREAKDOWN DETECTION FLOW CHART	Folio 1/5
	NO PLATFORM ROTATION MOVEMENT (RIGHT AND / OR LEFT)	

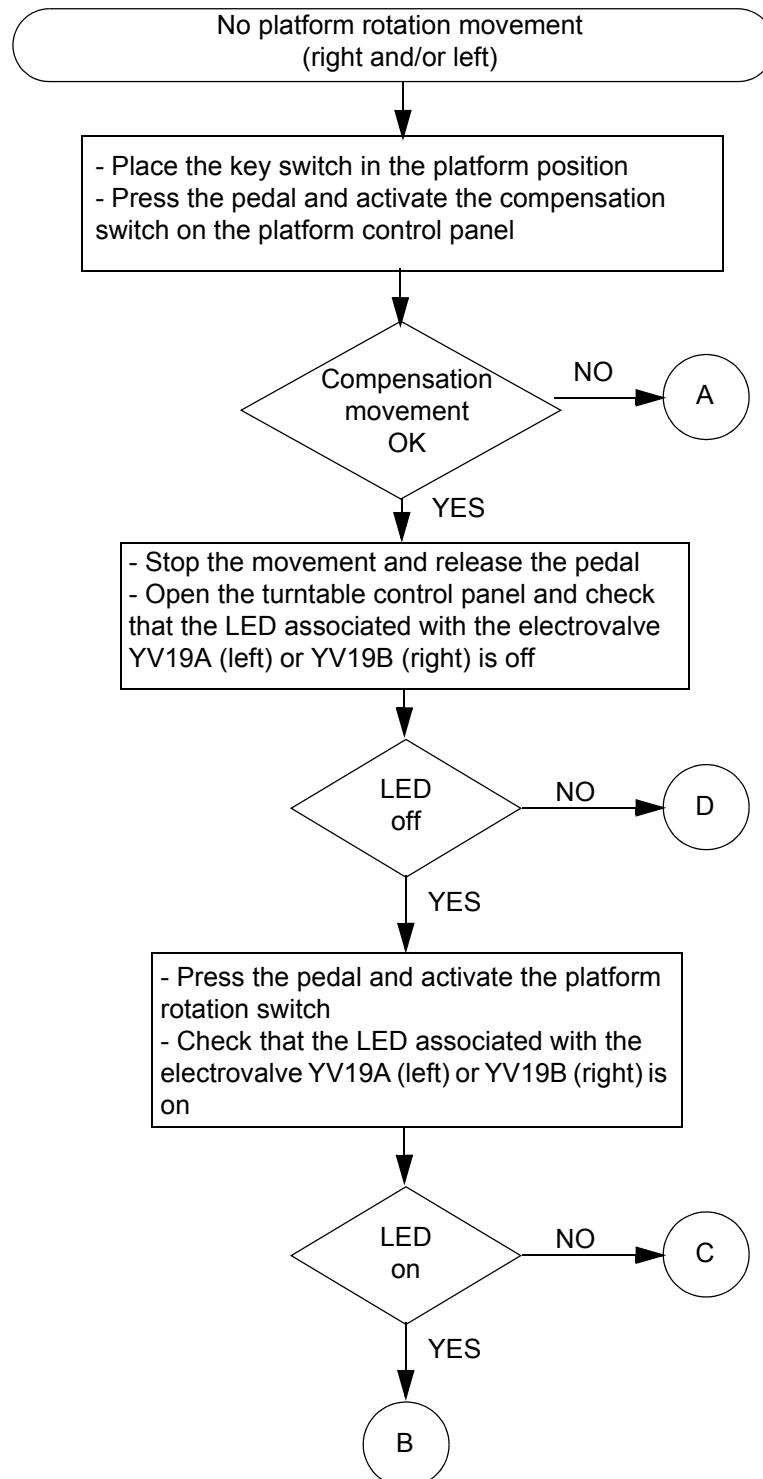

Sheet DP027	BREAKDOWN DETECTION FLOW CHART	Folio 2/5
	NO PLATFORM ROTATION MOVEMENT (RIGHT AND / OR LEFT)	

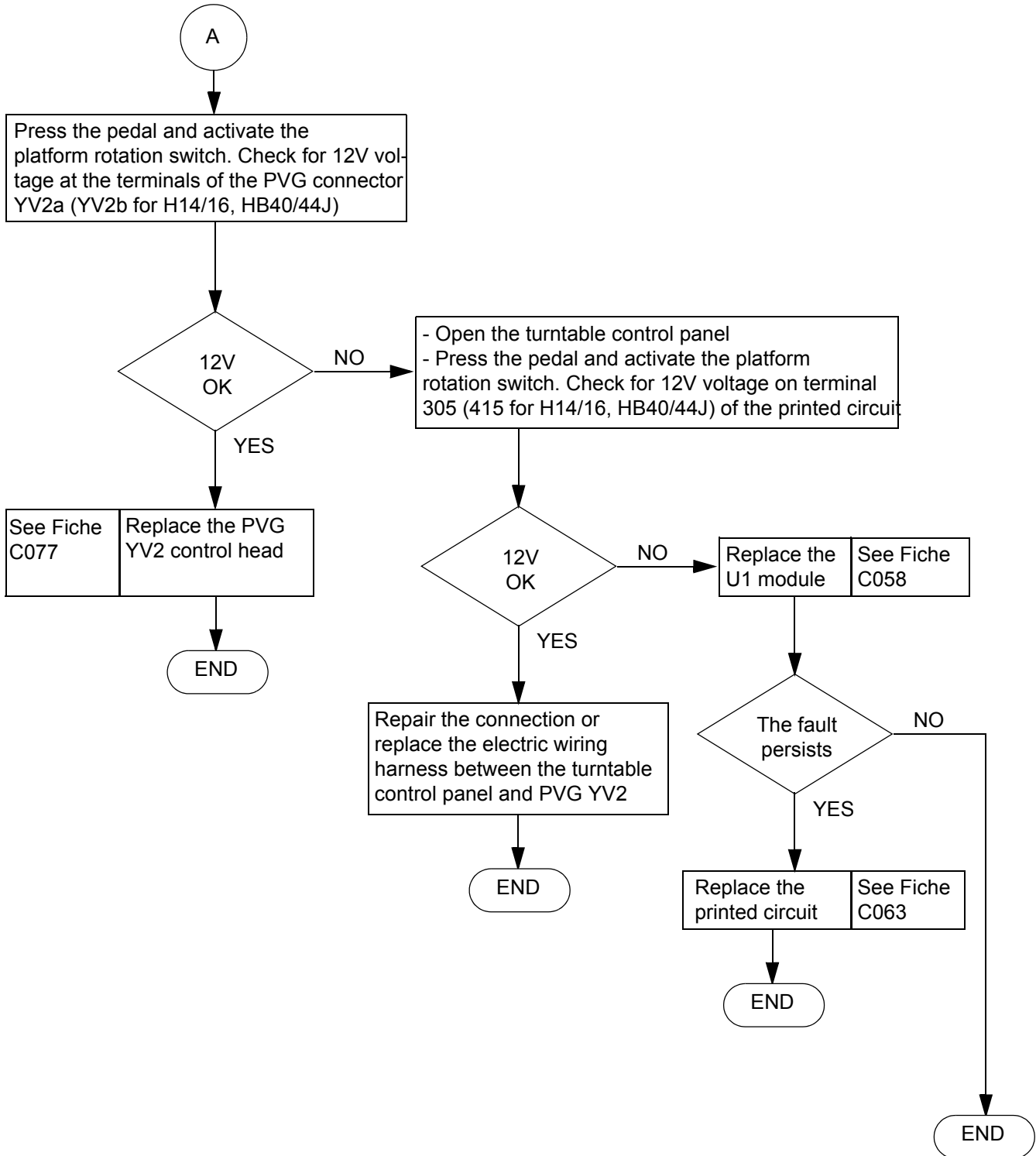

Sheet DP027	BREAKDOWN DETECTION FLOW CHART	Folio 3/5
	NO PLATFORM ROTATION MOVEMENT (RIGHT AND / OR LEFT)	

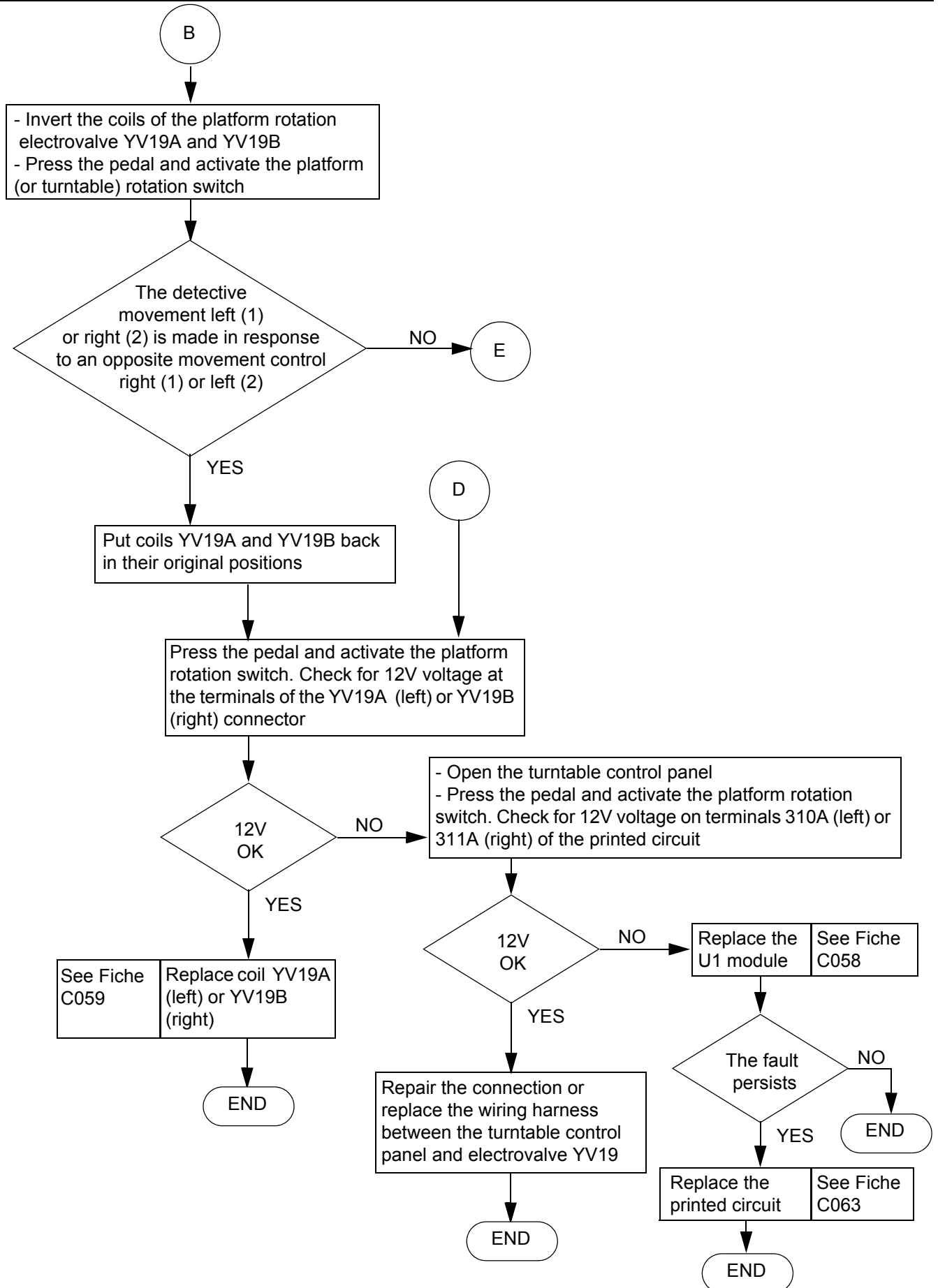

Sheet DP027	BREAKDOWN DETECTION FLOW CHART	Folio 4/5
	NO PLATFORM ROTATION MOVEMENT (RIGHT AND / OR LEFT)	

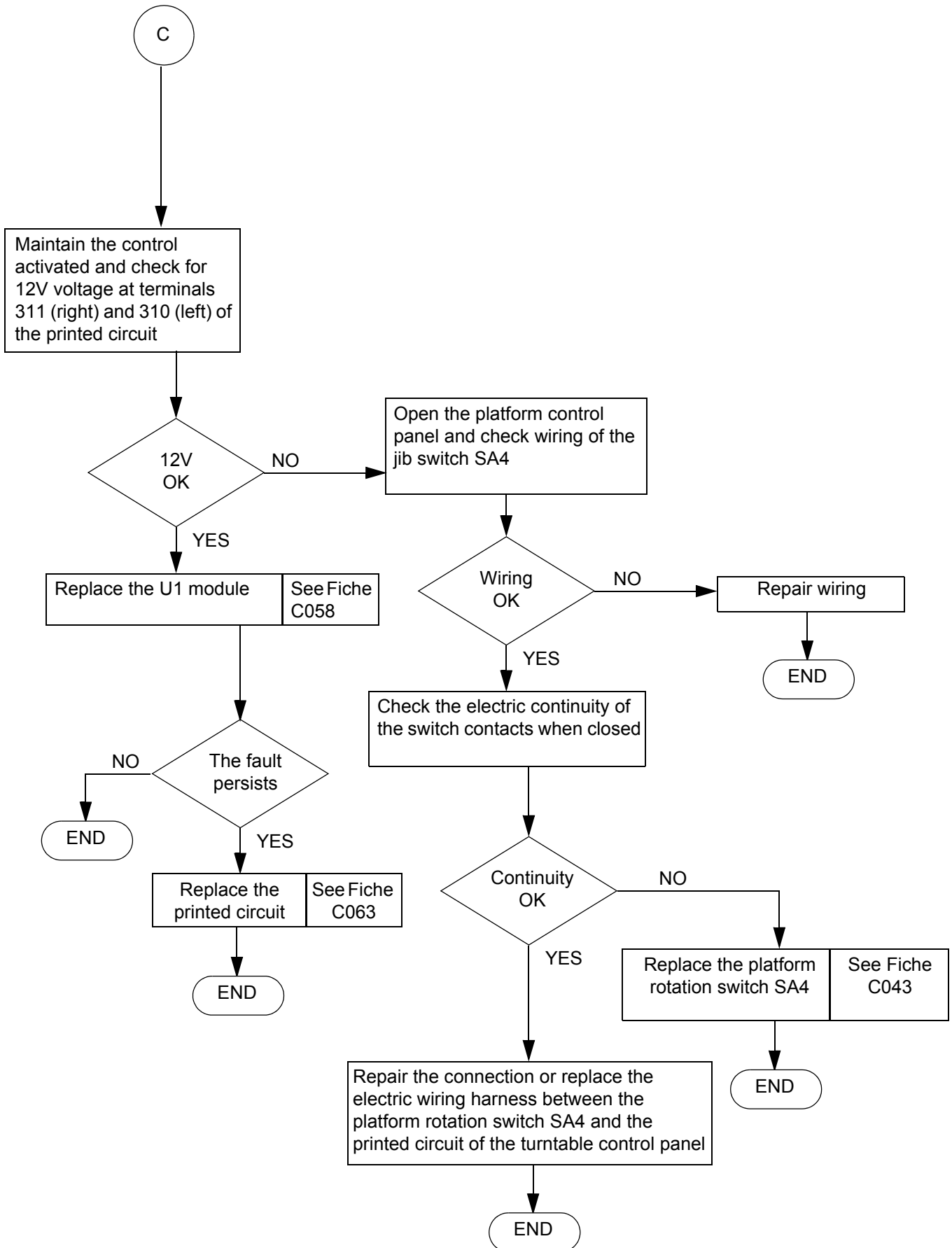

Sheet DP027	BREAKDOWN DETECTION FLOW CHART	Folio 5/5
	NO PLATFORM ROTATION MOVEMENT (RIGHT AND / OR LEFT)	

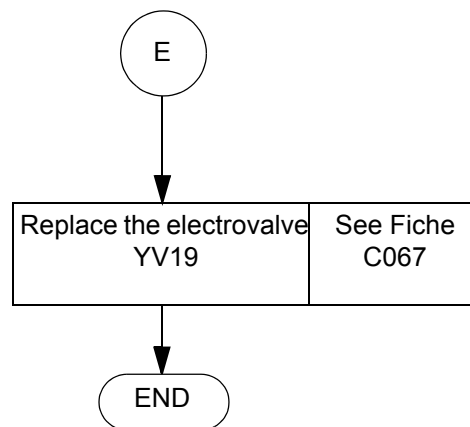

Sheet DP028	BREAKDOWN DETECTION FLOW CHART	Folio 1/5
	NO JIB MOVEMENT (UP AND / OR DOWN) FROM THE PLATFORM (OR TURNTABLE) CONTROL PANEL	

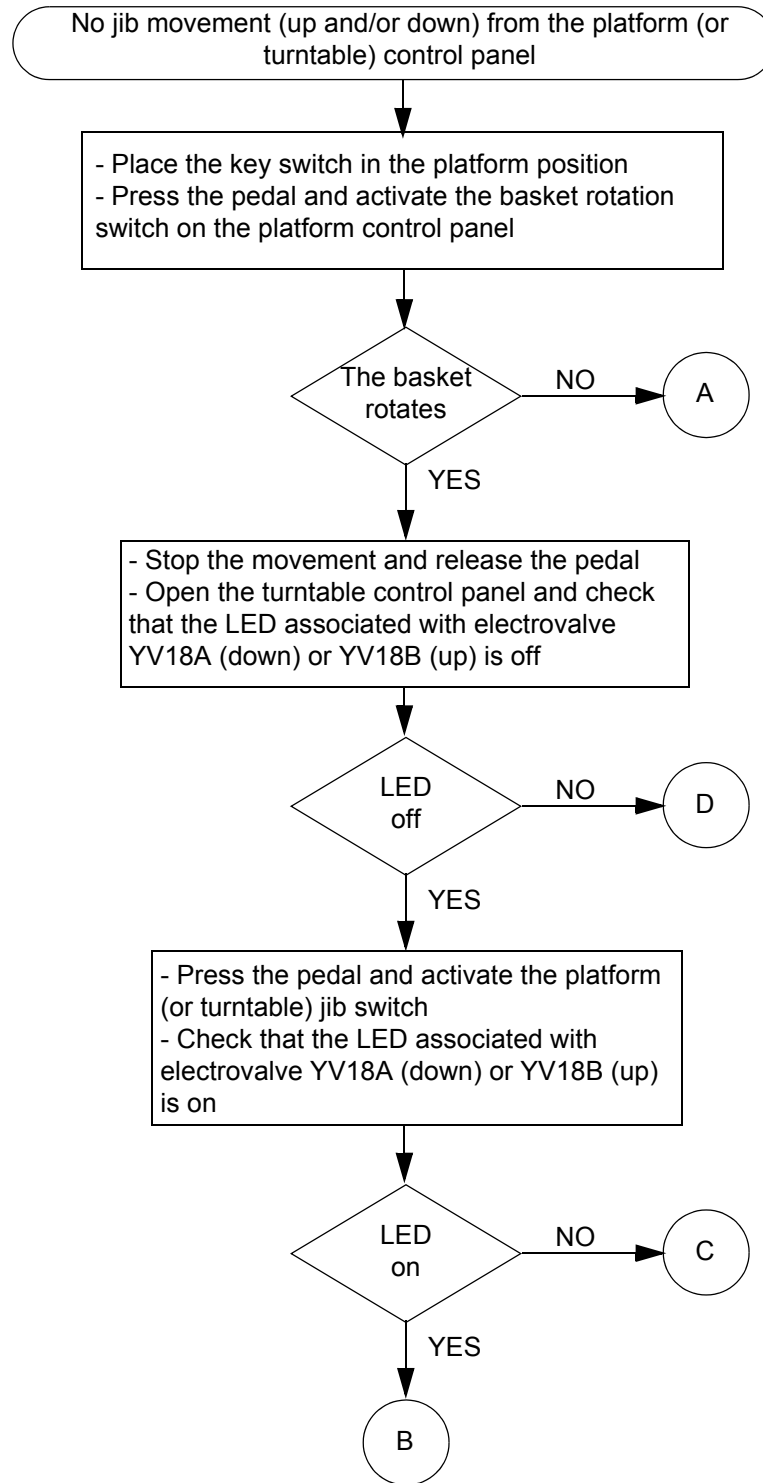

Sheet DP028	BREAKDOWN DETECTION FLOW CHART	Folio 2/5
	NO JIB MOVEMENT (UP AND / OR DOWN) FROM THE PLATFORM (OR TURNTABLE) CONTROL PANEL	

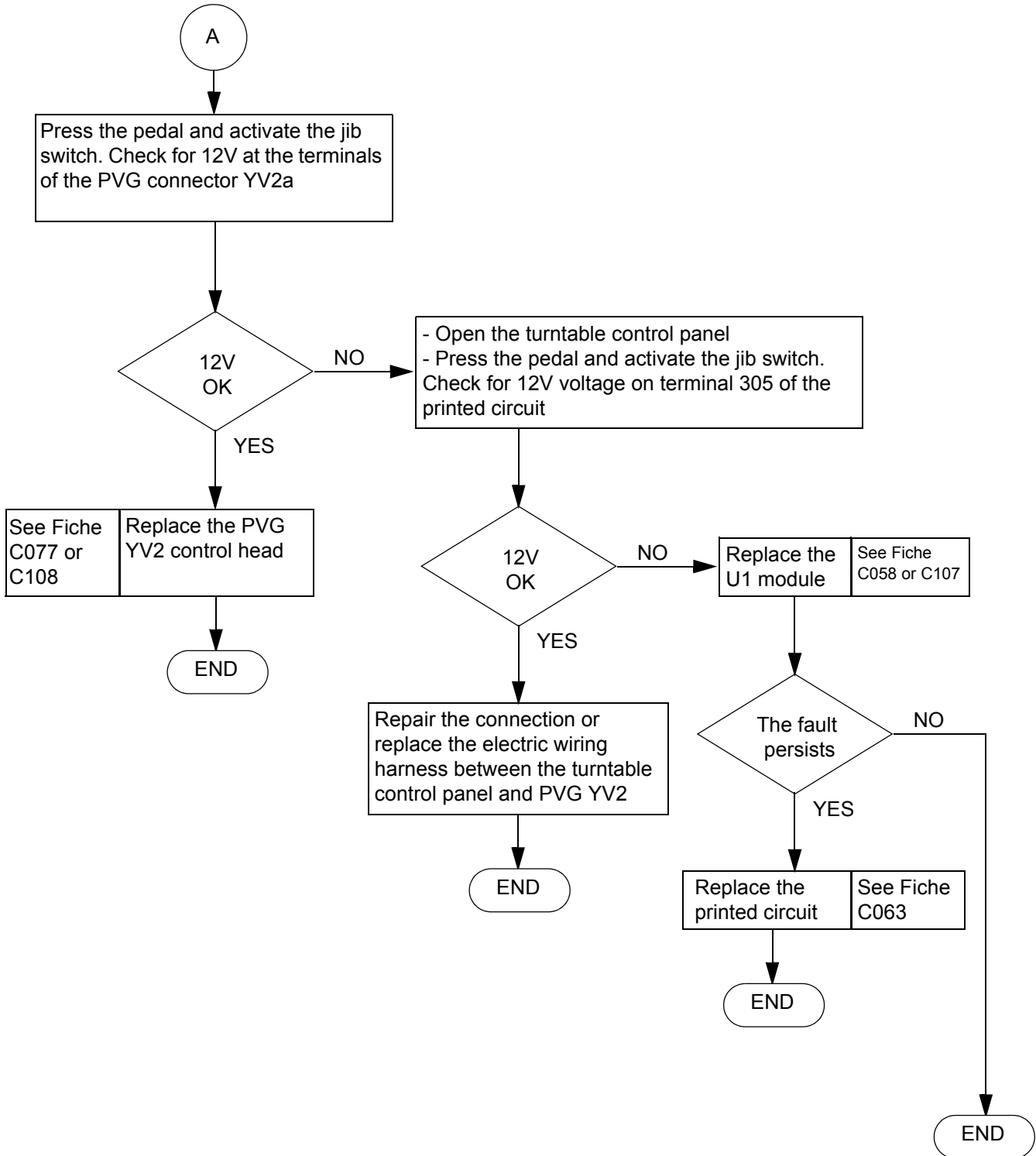

Sheet DP028	BREAKDOWN DETECTION FLOW CHART	Folio 3/5
	NO JIB MOVEMENT (UP AND / OR DOWN) FROM THE PLATFORM (OR TURNTABLE) CONTROL PANEL	

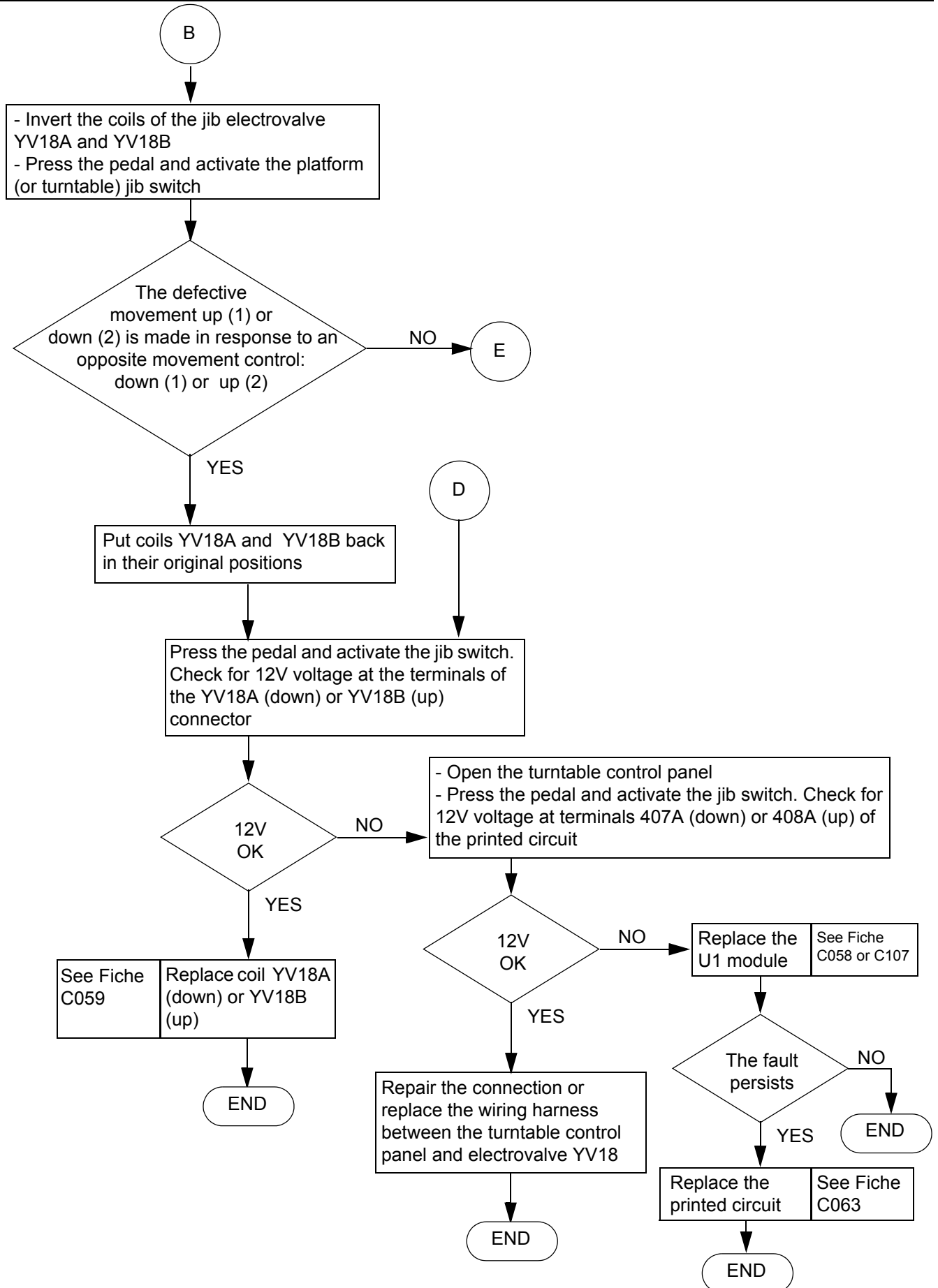

Sheet DP028	BREAKDOWN DETECTION FLOW CHART	Folio 4/5
	NO JIB MOVEMENT (UP AND / OR DOWN) FROM THE PLATFORM (OR TURNTABLE) CONTROL PANEL	

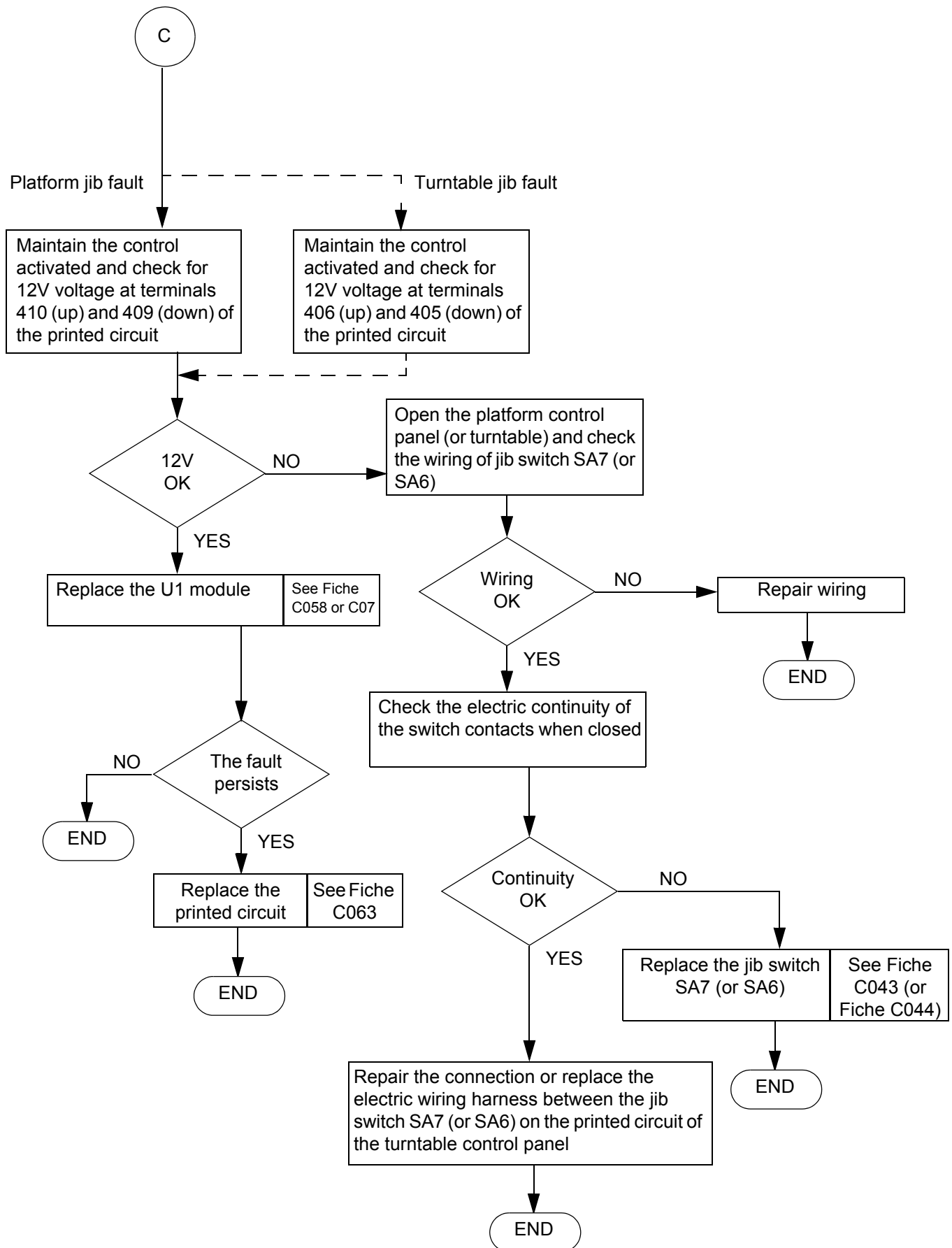

Sheet DP028	BREAKDOWN DETECTION FLOW CHART	Folio 5/5
	NO JIB MOVEMENT (UP AND / OR DOWN) FROM THE PLATFORM (OR TURNTABLE) CONTROL PANEL	

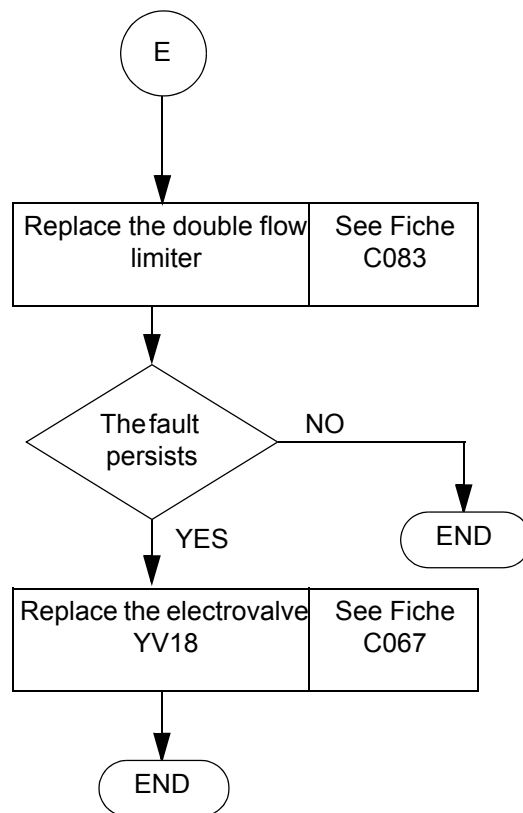

Sheet DP031	BREAKDOWN DETECTION FLOW CHART	Folio 1/3
	NO ARM LIFTING MOVEMENT (UP AND / OR DOWN) FROM THE PLATFORM (OR TURNTABLE) CONTROL PANEL	

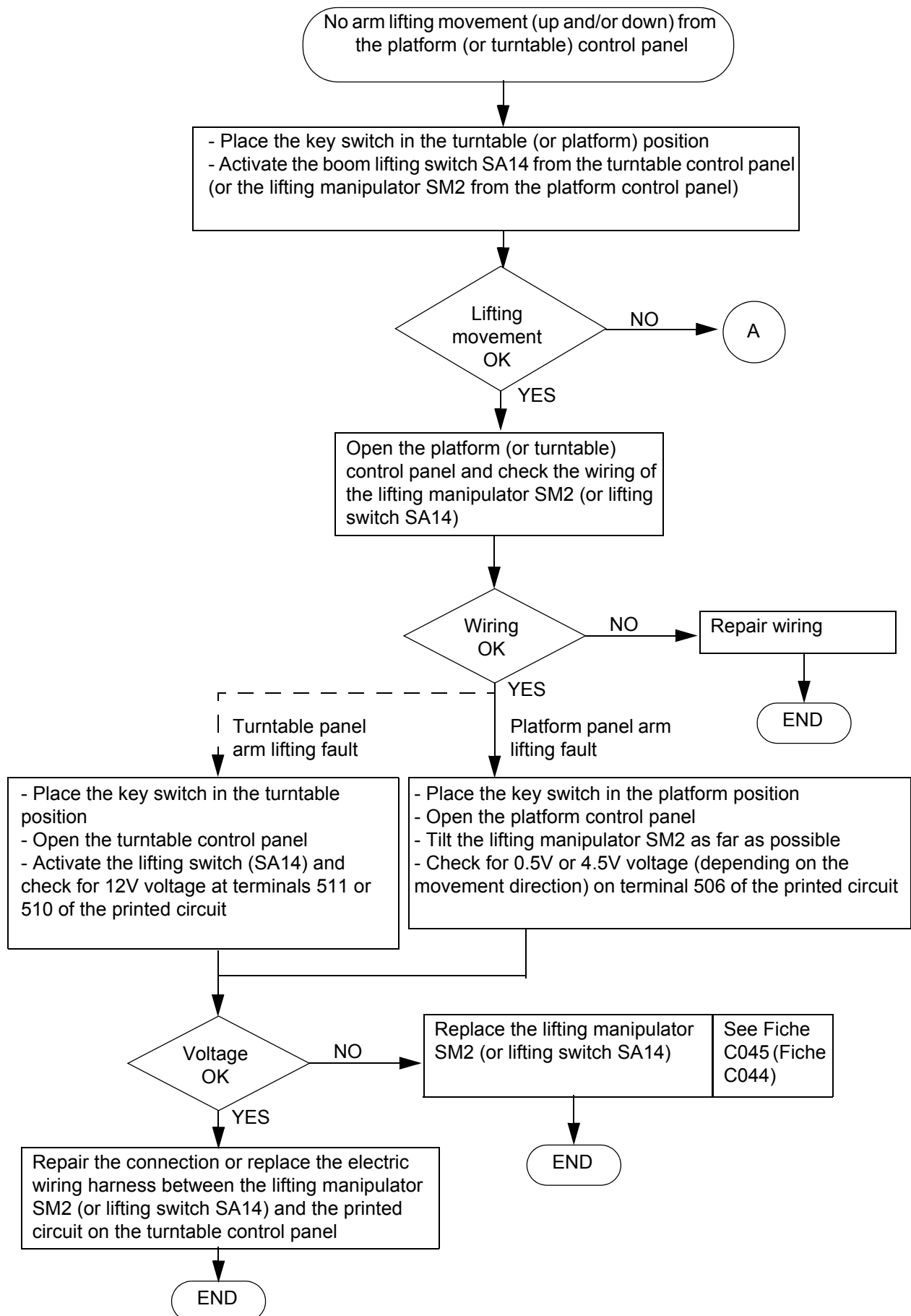

Sheet DP031	BREAKDOWN DETECTION FLOW CHART	Folio 2/3
	NO ARM LIFTING MOVEMENT (UP AND / OR DOWN) FROM THE PLATFORM (OR TURNTABLE) CONTROL PANEL	

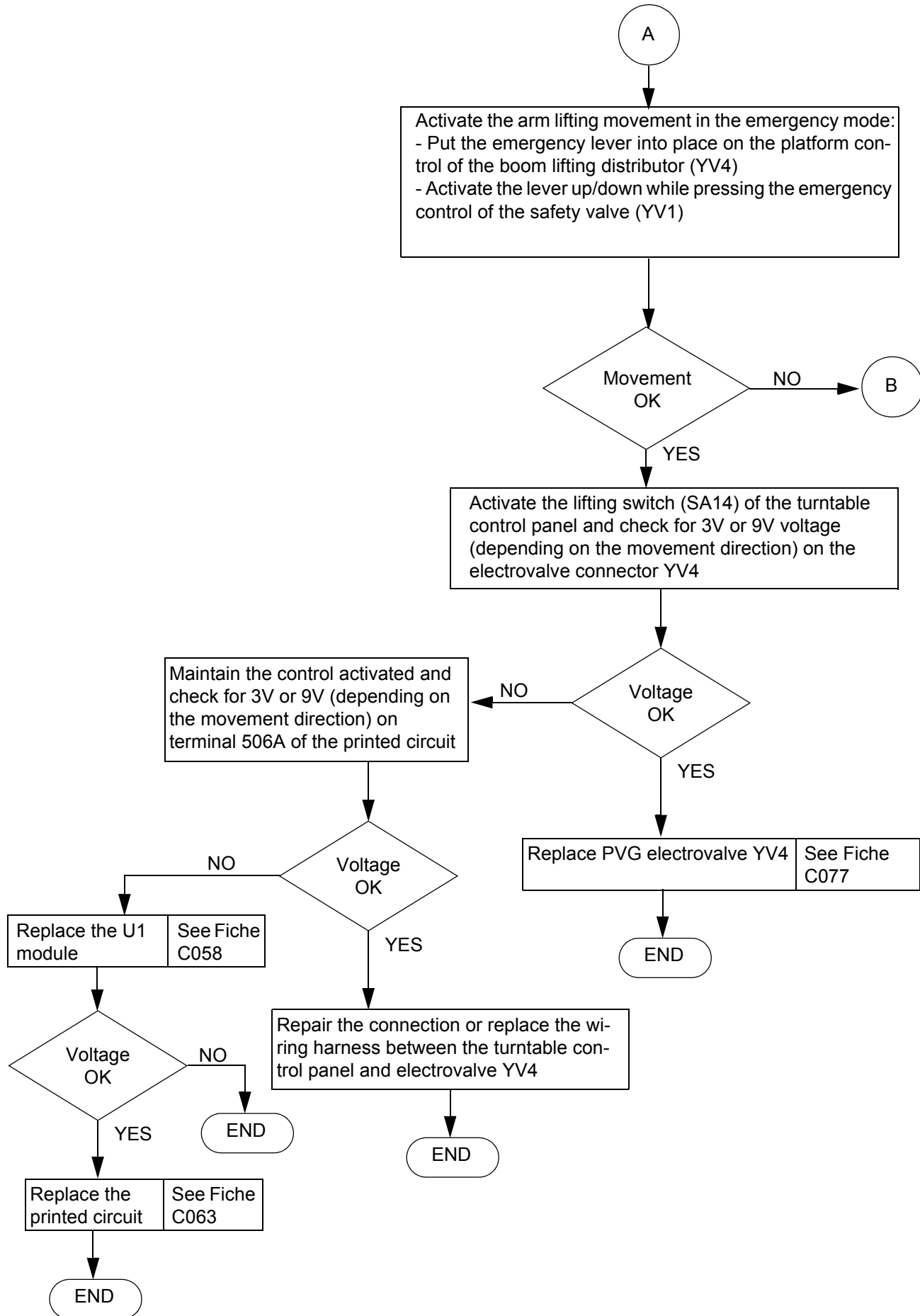

Sheet DP031	BREAKDOWN DETECTION FLOW CHART	Folio 3/3
	NO ARM LIFTING MOVEMENT (UP AND / OR DOWN) FROM THE PLATFORM (OR TURNTABLE) CONTROL PANEL	

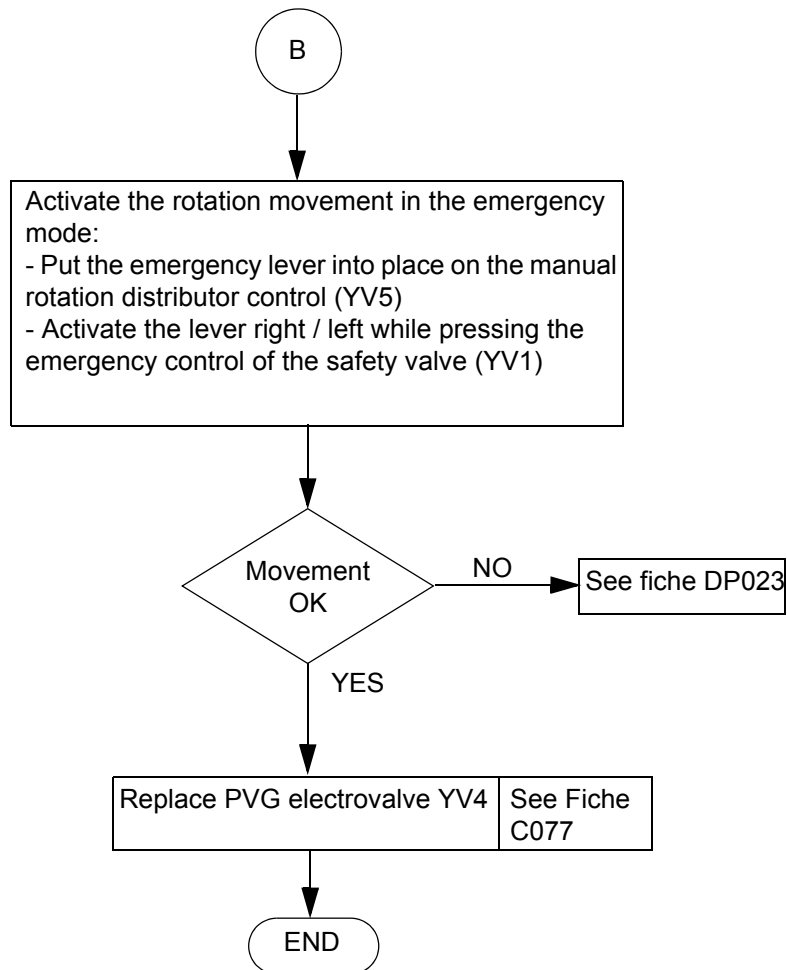

Sheet DP032	BREAKDOWN DETECTION FLOW CHART	Folio 1/4
	NO MACHINE TRAVEL MOVEMENT	

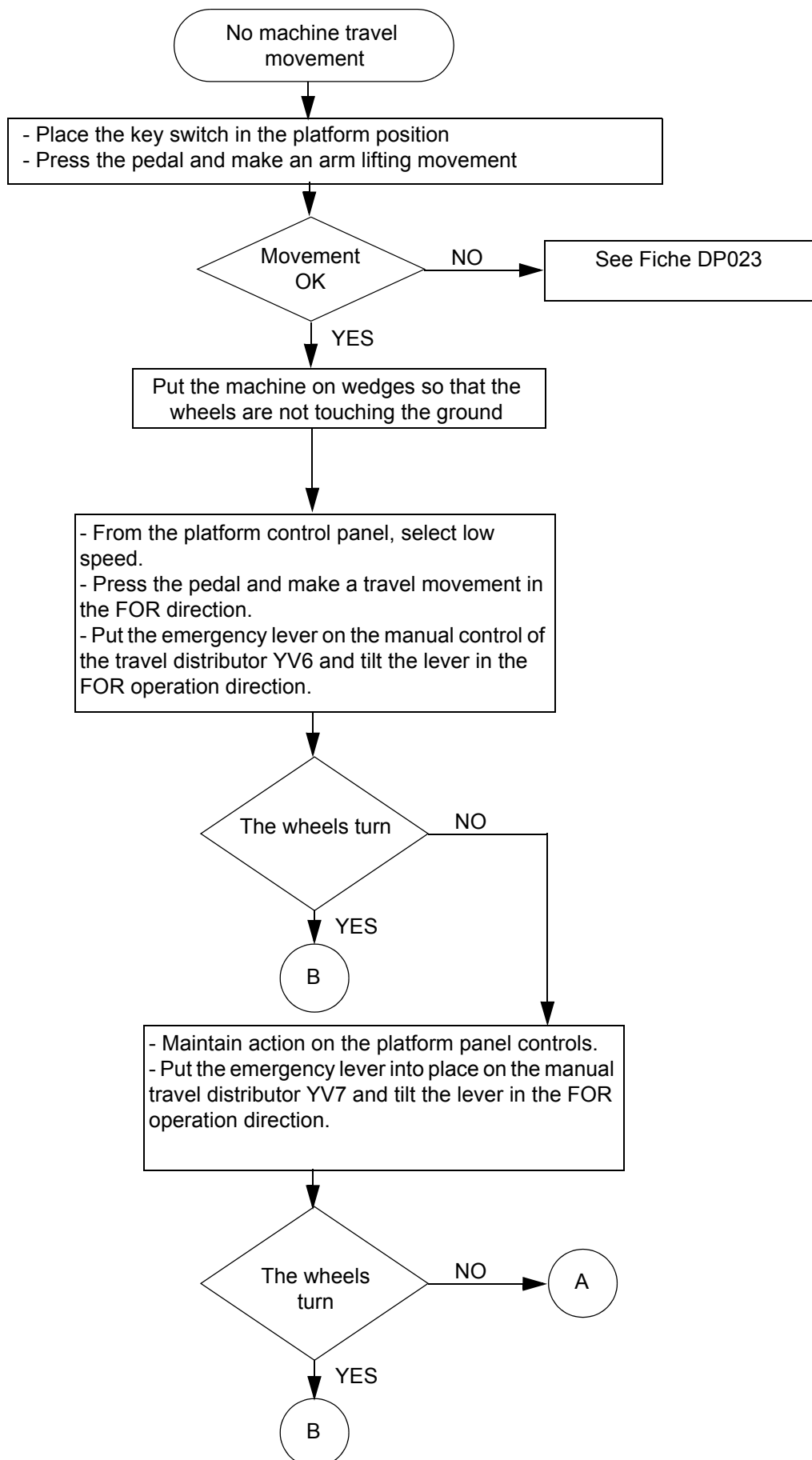

Sheet DP032	BREAKDOWN DETECTION FLOW CHART	Folio 2/4
	NO MACHINE TRAVEL MOVEMENT	

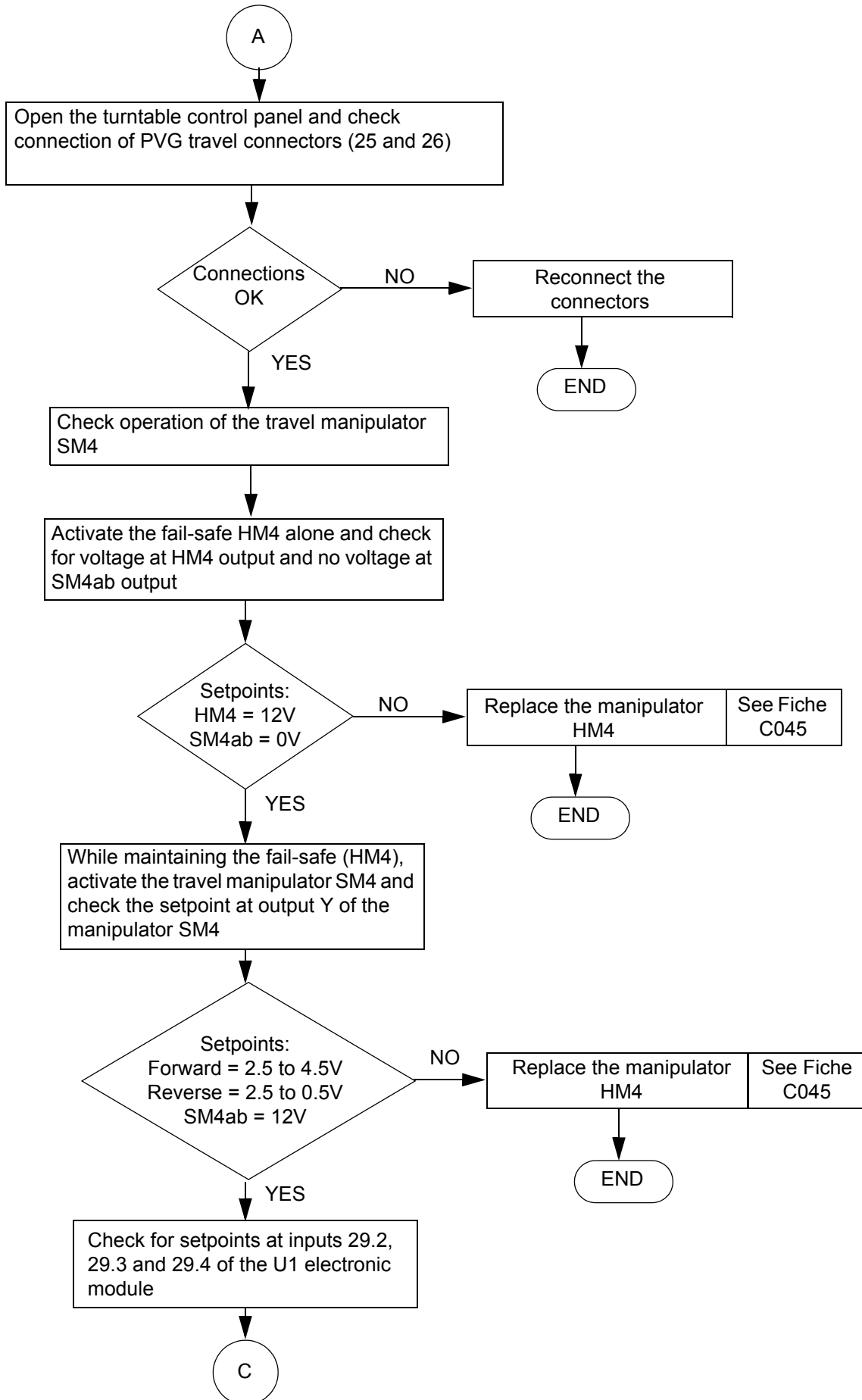

Sheet DP032	BREAKDOWN DETECTION FLOW CHART	Folio 3/4
	NO MACHINE TRAVEL MOVEMENT	

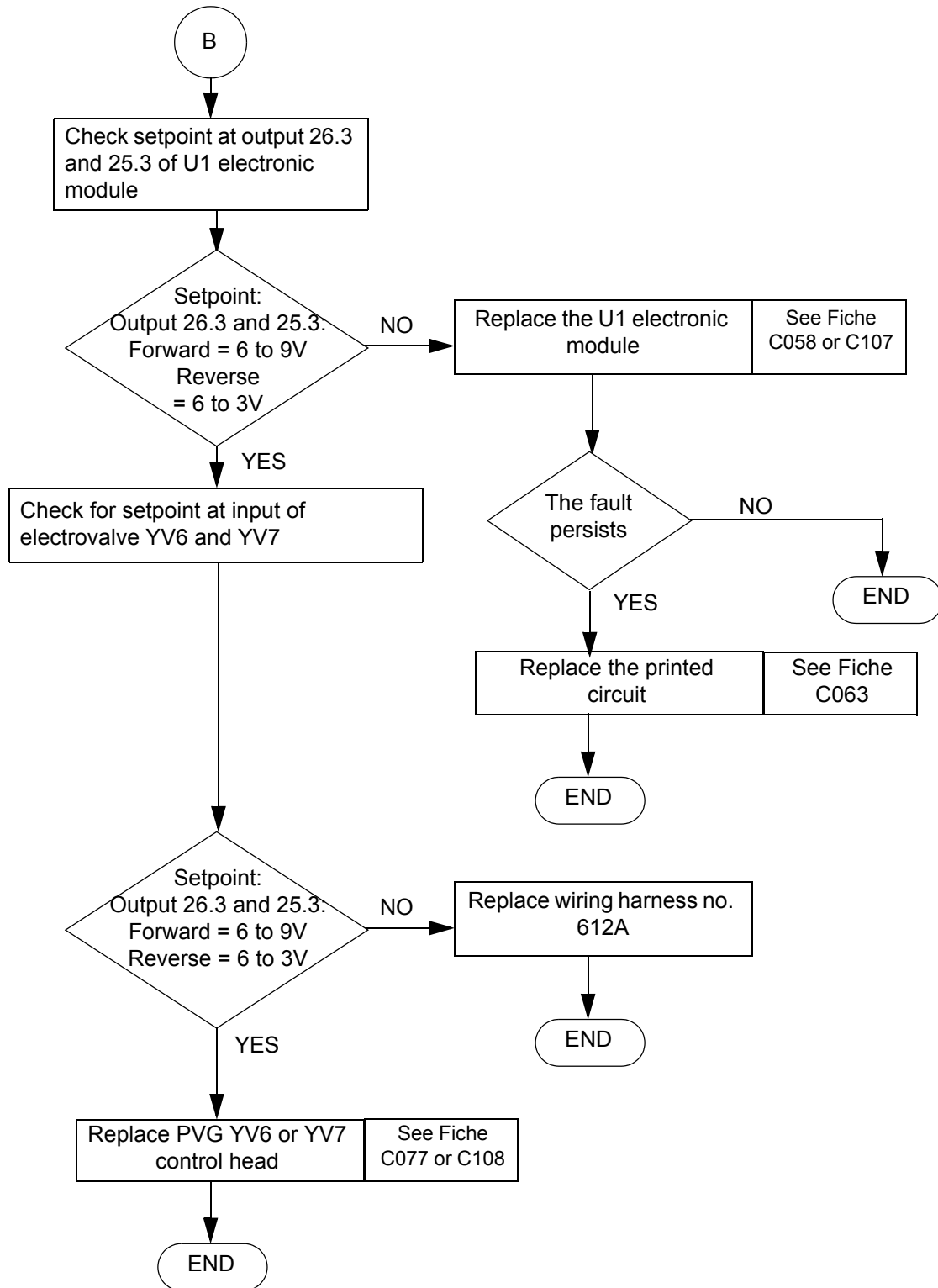

Sheet DP032	BREAKDOWN DETECTION FLOW CHART	Folio 4/4
	NO MACHINE TRAVEL MOVEMENT	

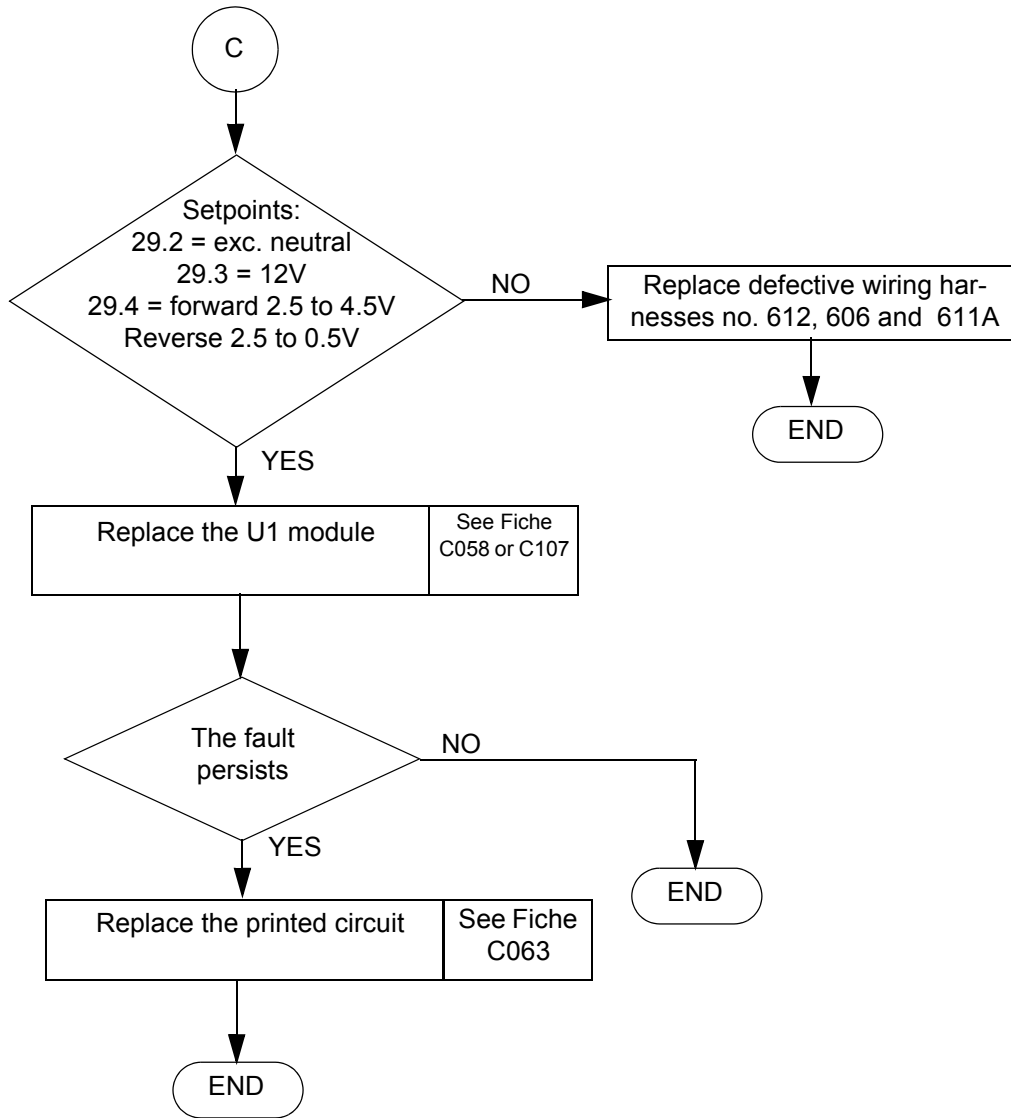

Sheet DP036	BREAKDOWN DETECTION FLOW CHART	Folio 1/3
	NO DIFFERENTIAL BLOCKING WHEN SWITCH SA3 IS ACTIVATED	

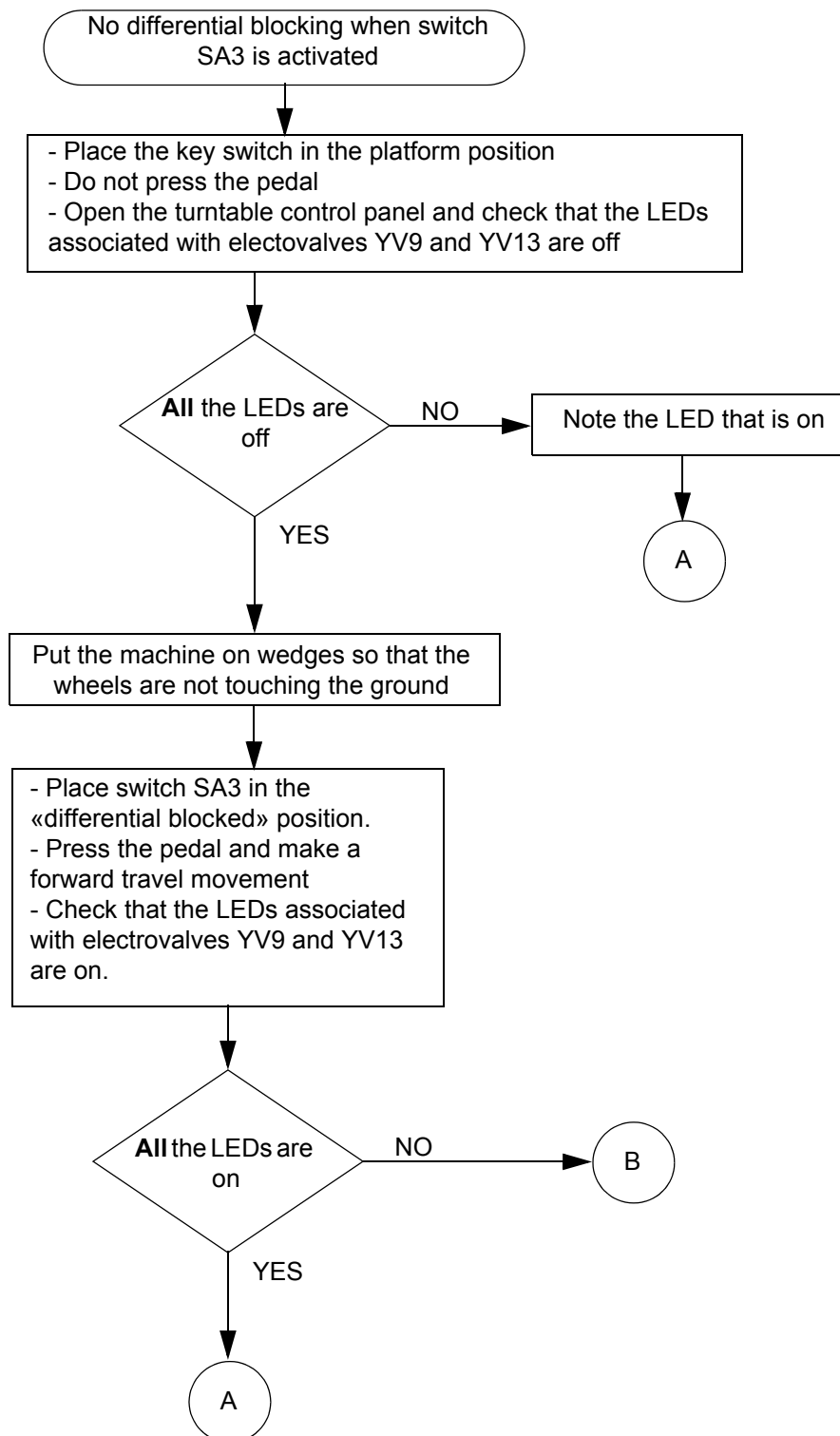

Sheet DP036	BREAKDOWN DETECTION FLOW CHART	Folio 2/3
	NO DIFFERENTIAL BLOCKING WHEN SWITCH SA3 IS ACTIVATED	

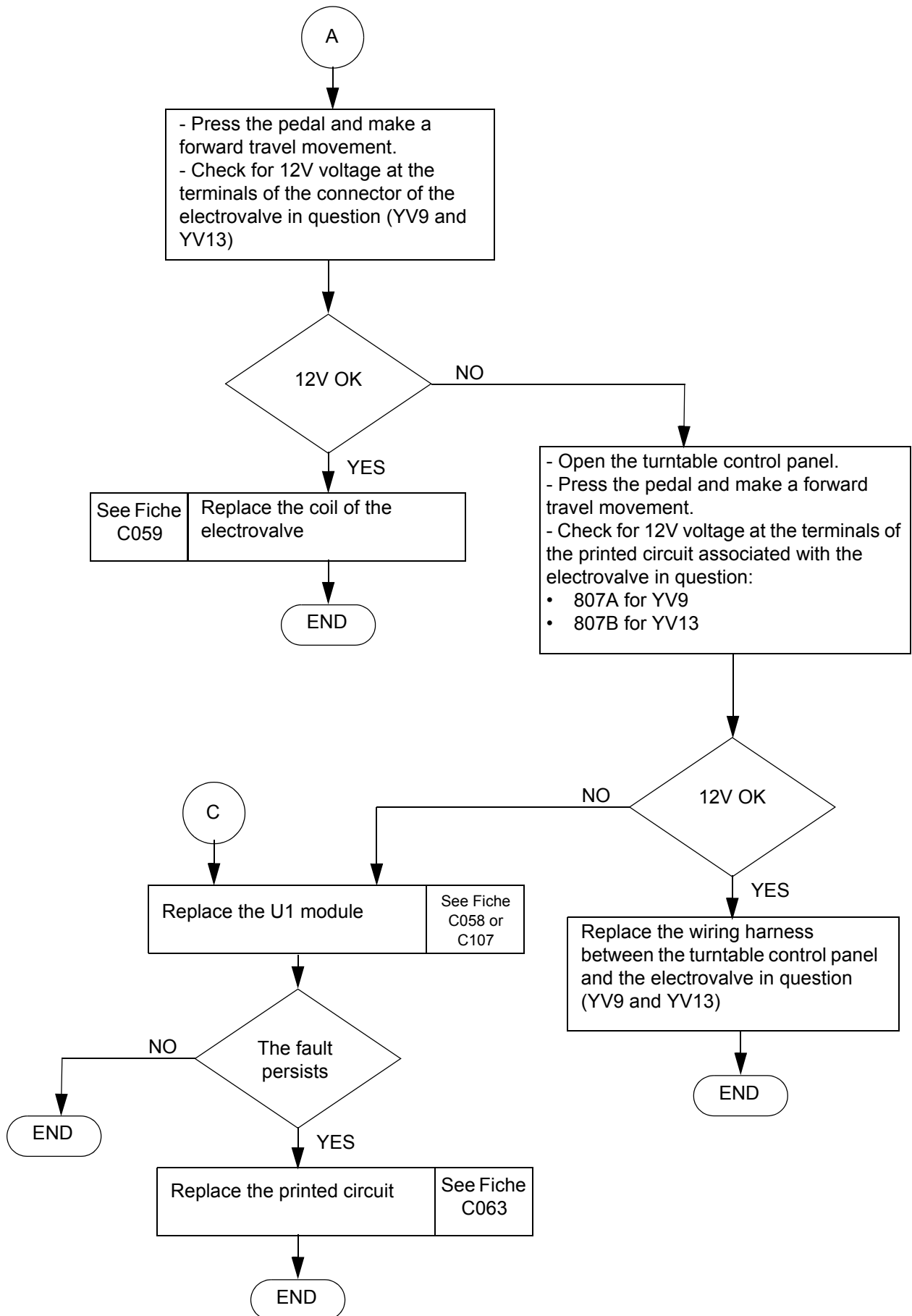

Sheet DP036	BREAKDOWN DETECTION FLOW CHART	Folio 3/3
	NO DIFFERENTIAL BLOCKING WHEN SWITCH SA3 IS ACTIVATED	

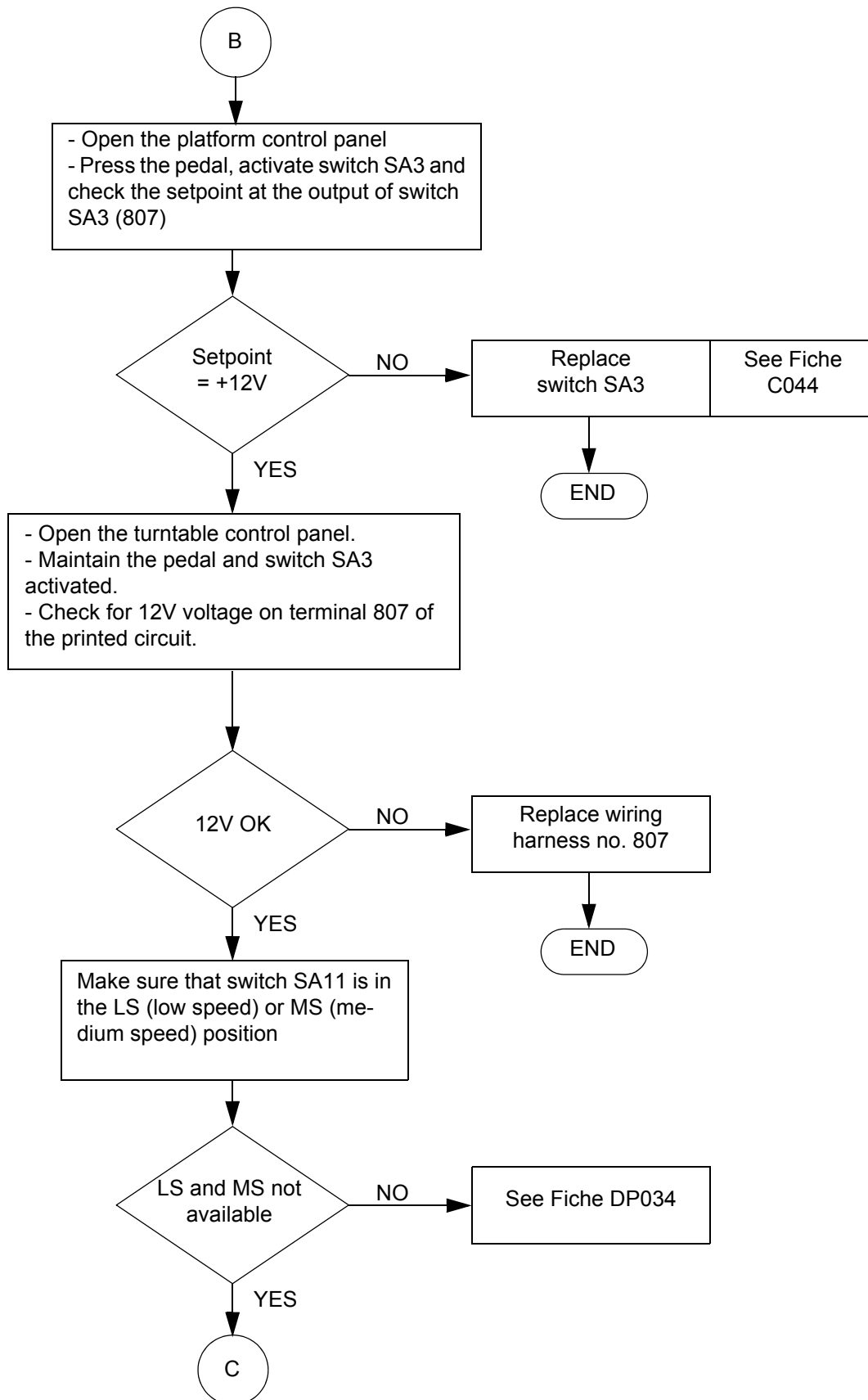

Sheet DP037	BREAKDOWN DETECTION FLOW CHART	Folio 1/4
	NO STEERING MOVEMENT (RIGHT AND/OR LEFT) ON THE FRONT AXLE	

No steering movement
(right and/or left) on the front axle

- Place the key switch in the platform position.
- Put the emergency lever into place on the manual control of the ON/OFF distributor YV2.
- Press the pedal and make a travel movement.
- Activate the FRONT steering switch SA12 while activating the emergency lever of distributor YV2 (direction YV2b)

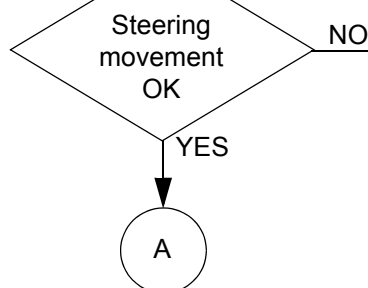

- Open the turntable control panel and check that the LEDs associated with electrovalve YV22A (left) / YV22B (right) and YV2B are off

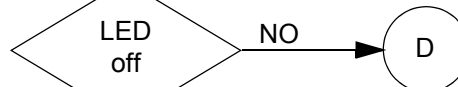

Put the machine on wedges so that the wheels are not touching the ground

- Press the pedal and make a travel movement: Activate the FRONT steering switch SA12.
- Check that the LED associated with electrovalve YV22A (left) or YV22B (right) is on

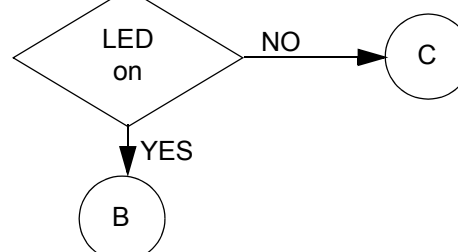

Sheet DP037	BREAKDOWN DETECTION FLOW CHART	Folio 2/4
	NO STEERING MOVEMENT (RIGHT AND/OR LEFT) ON THE FRONT AXLE	

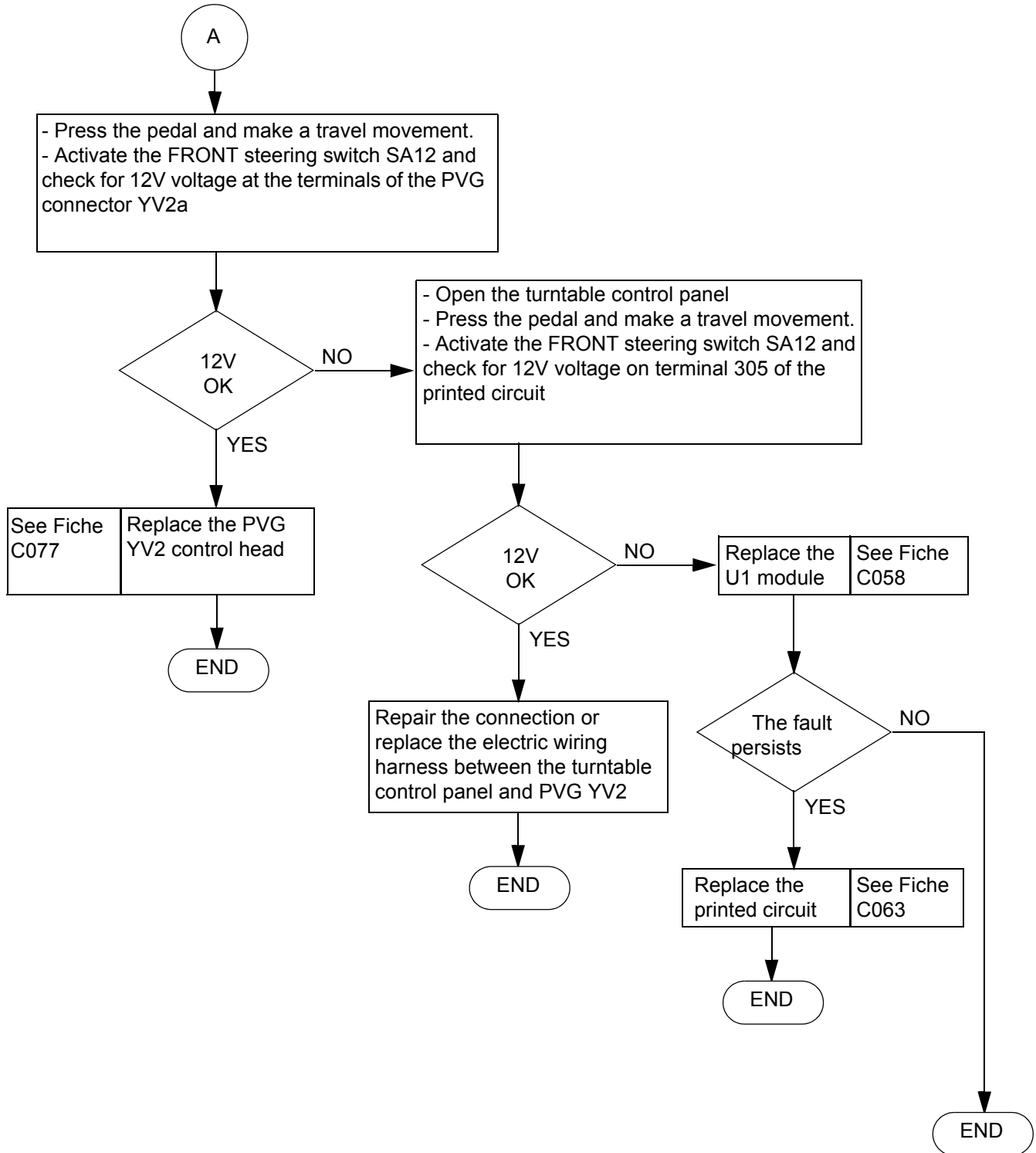

Sheet DP037	BREAKDOWN DETECTION FLOW CHART	Folio 3/4
	NO STEERING MOVEMENT (RIGHT AND/OR LEFT) ON THE FRONT AXLE	

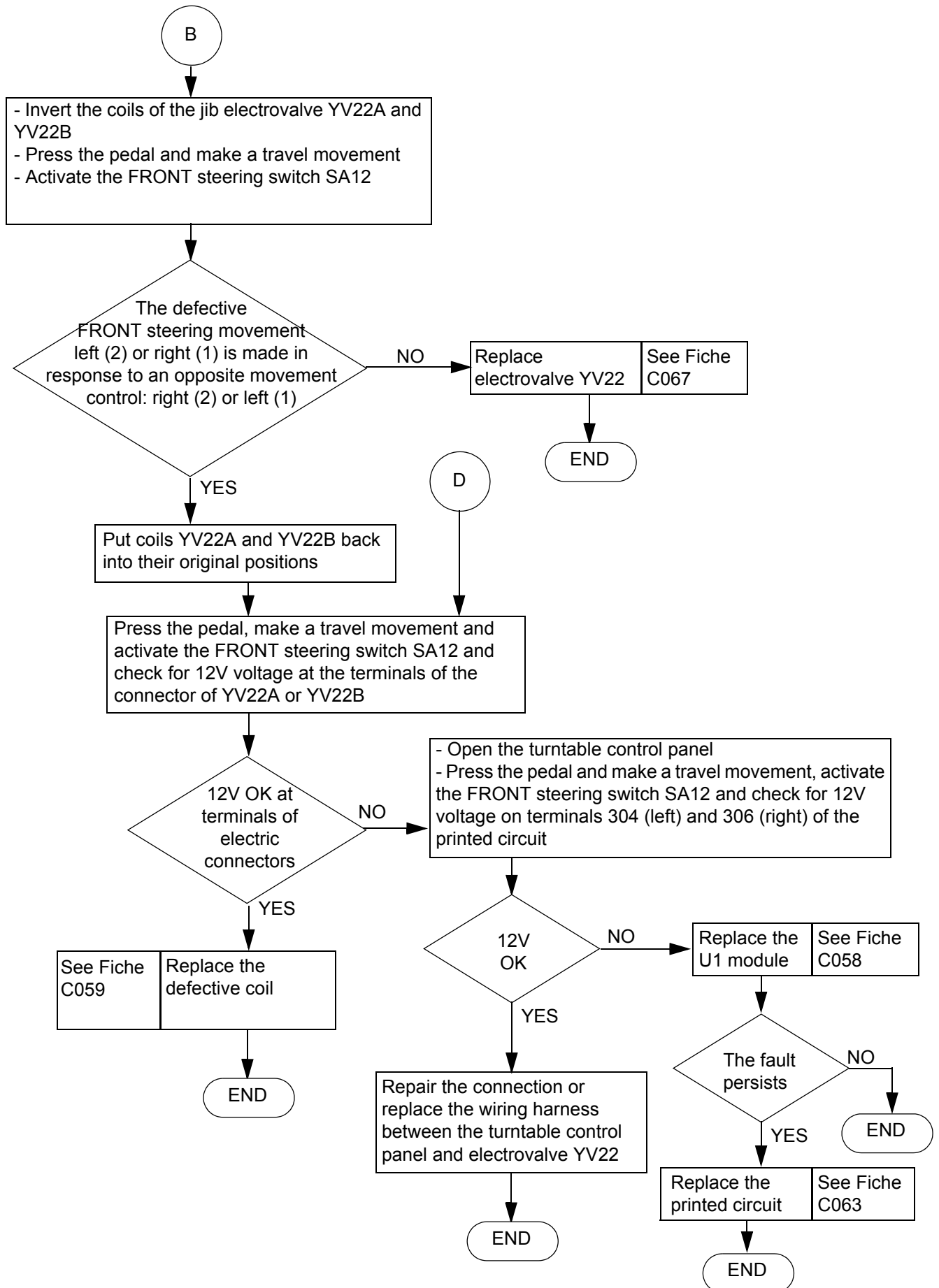

Sheet DP037	BREAKDOWN DETECTION FLOW CHART	Folio 4/4
	NO STEERING MOVEMENT (RIGHT AND/OR LEFT) ON THE FRONT AXLE	

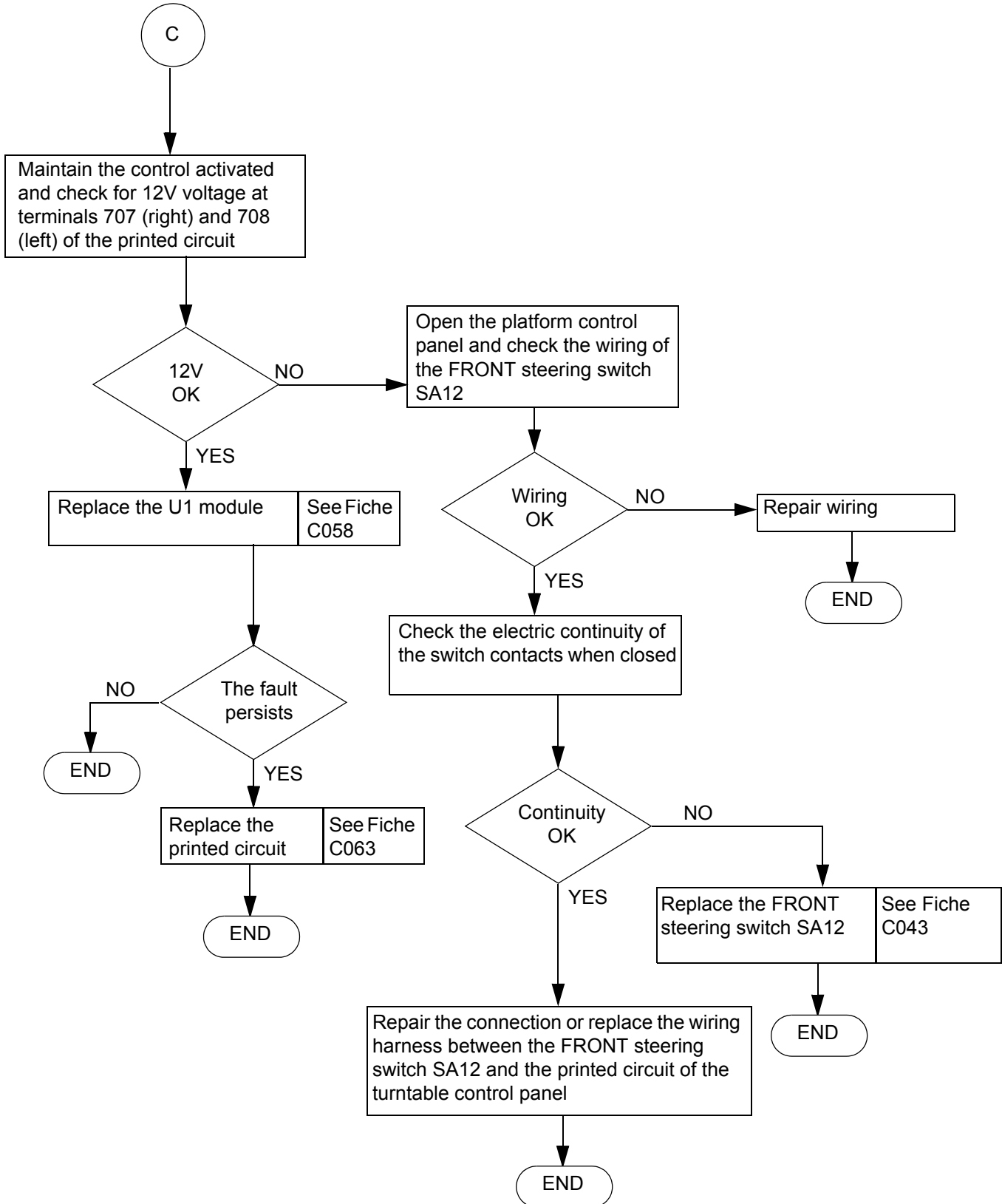

Sheet DP038	BREAKDOWN DETECTION FLOW CHART	Folio 1/4
	NO STEERING MOVEMENT (RIGHT AND/OR LEFT) ON THE REAR AXLE	

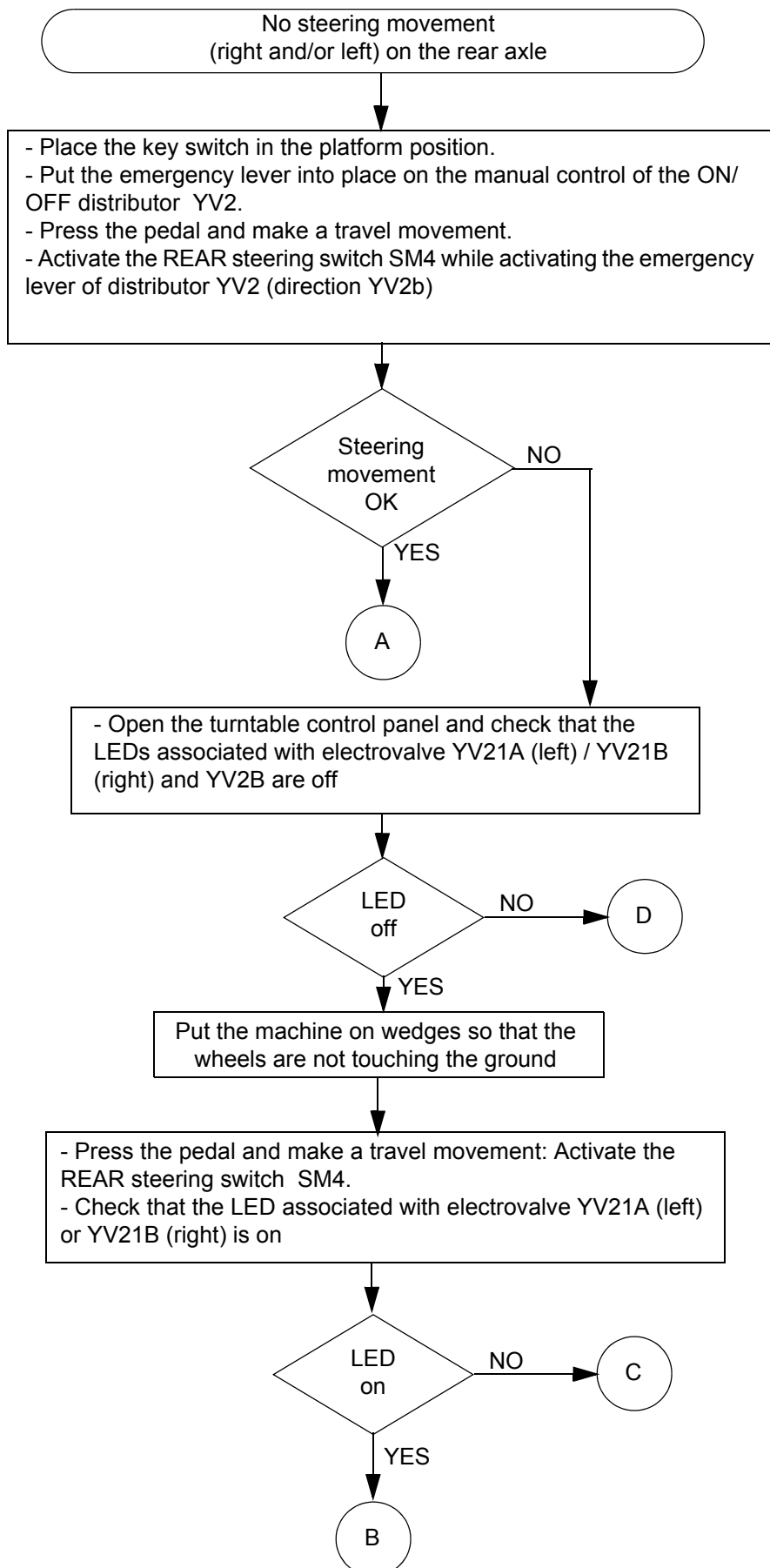

Sheet DP038	BREAKDOWN DETECTION FLOW CHART	Folio 2/4
	NO STEERING MOVEMENT (RIGHT AND/OR LEFT) ON THE REAR AXLE	

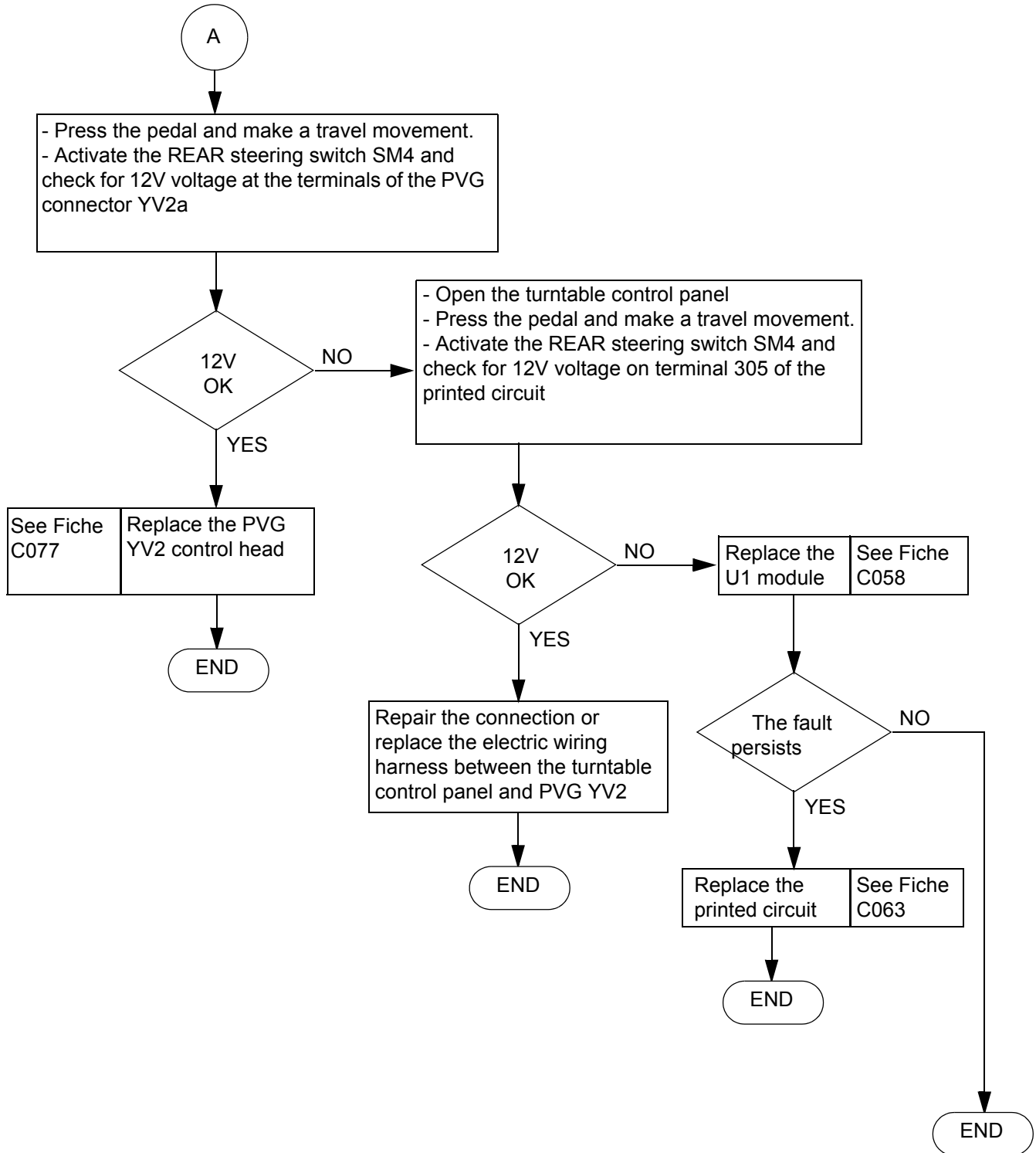

Sheet DP038	BREAKDOWN DETECTION FLOW CHART	Folio 3/4
	NO STEERING MOVEMENT (RIGHT AND/OR LEFT) ON THE REAR AXLE	

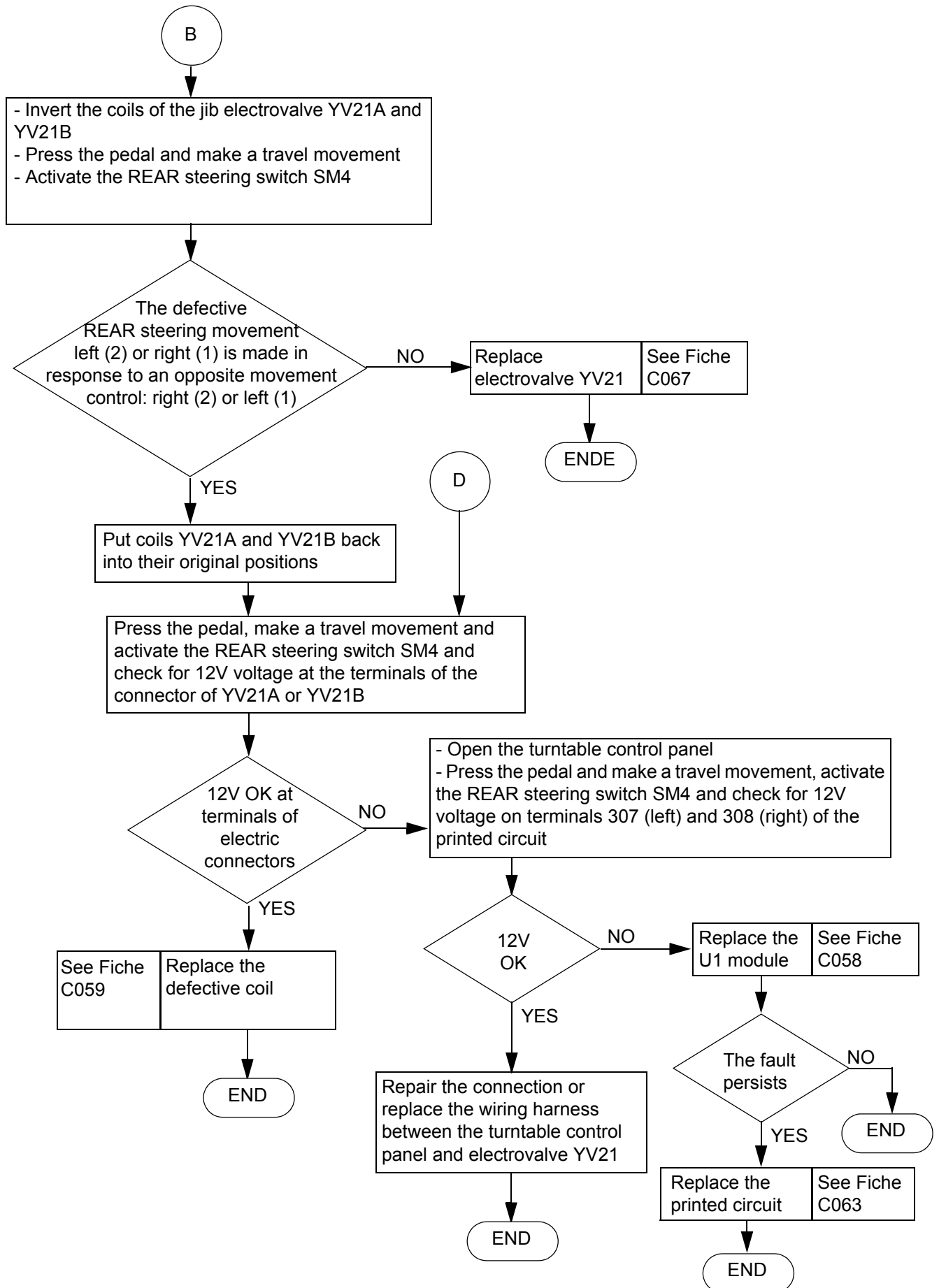

Sheet DP038	BREAKDOWN DETECTION FLOW CHART	Folio 4/4
	NO STEERING MOVEMENT (RIGHT AND/OR LEFT) ON THE REAR AXLE	

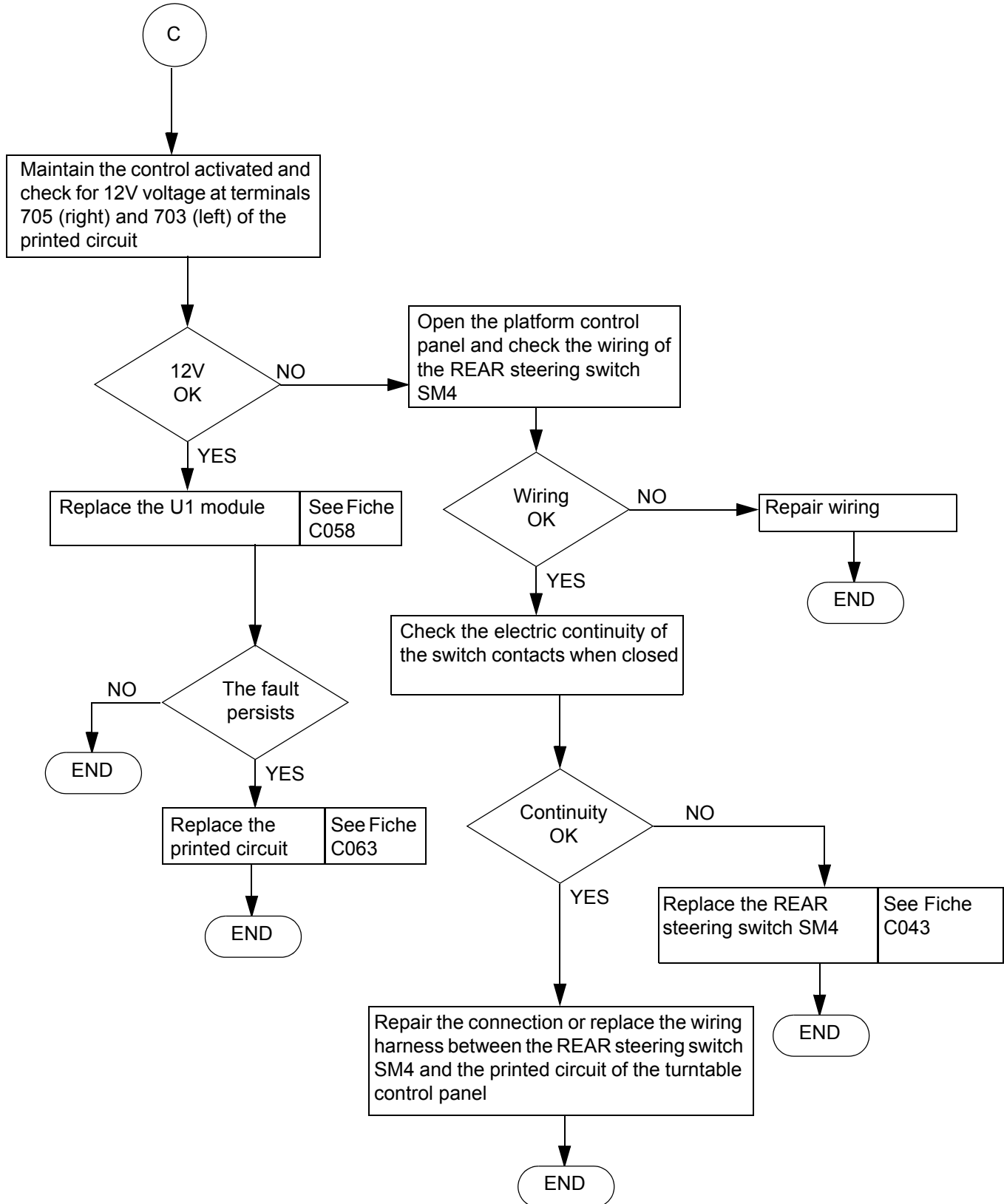

Sheet DP066	BREAKDOWN DETECTION FLOW CHART	Folio 1/4
	THE MOTOR DOES NOT START, THE STARTER IS ACTIVATED	

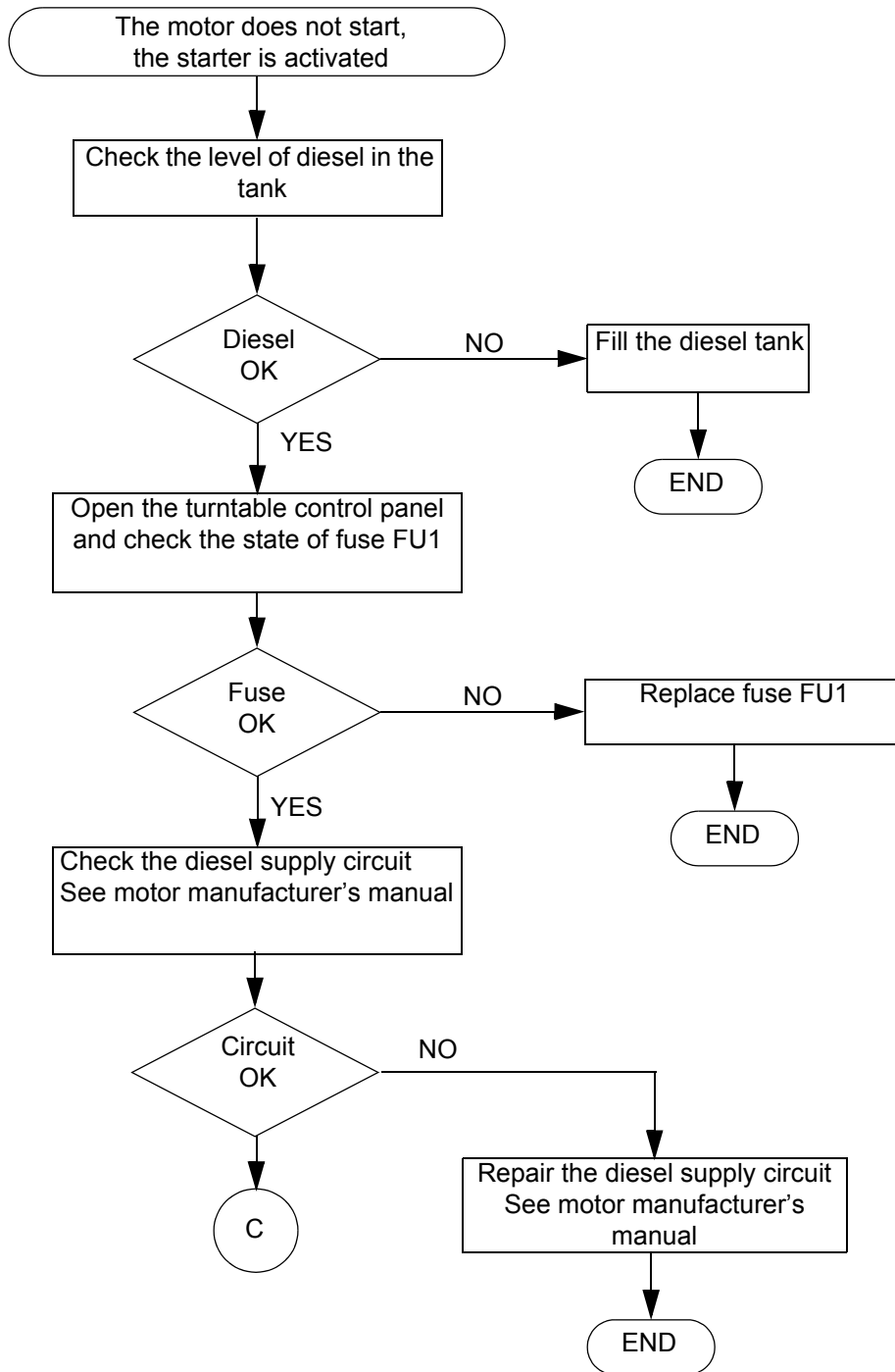

Sheet DP066	BREAKDOWN DETECTION FLOW CHART	Folio 2/4
	THE MOTOR DOES NOT START, THE STARTER IS ACTIVATED	

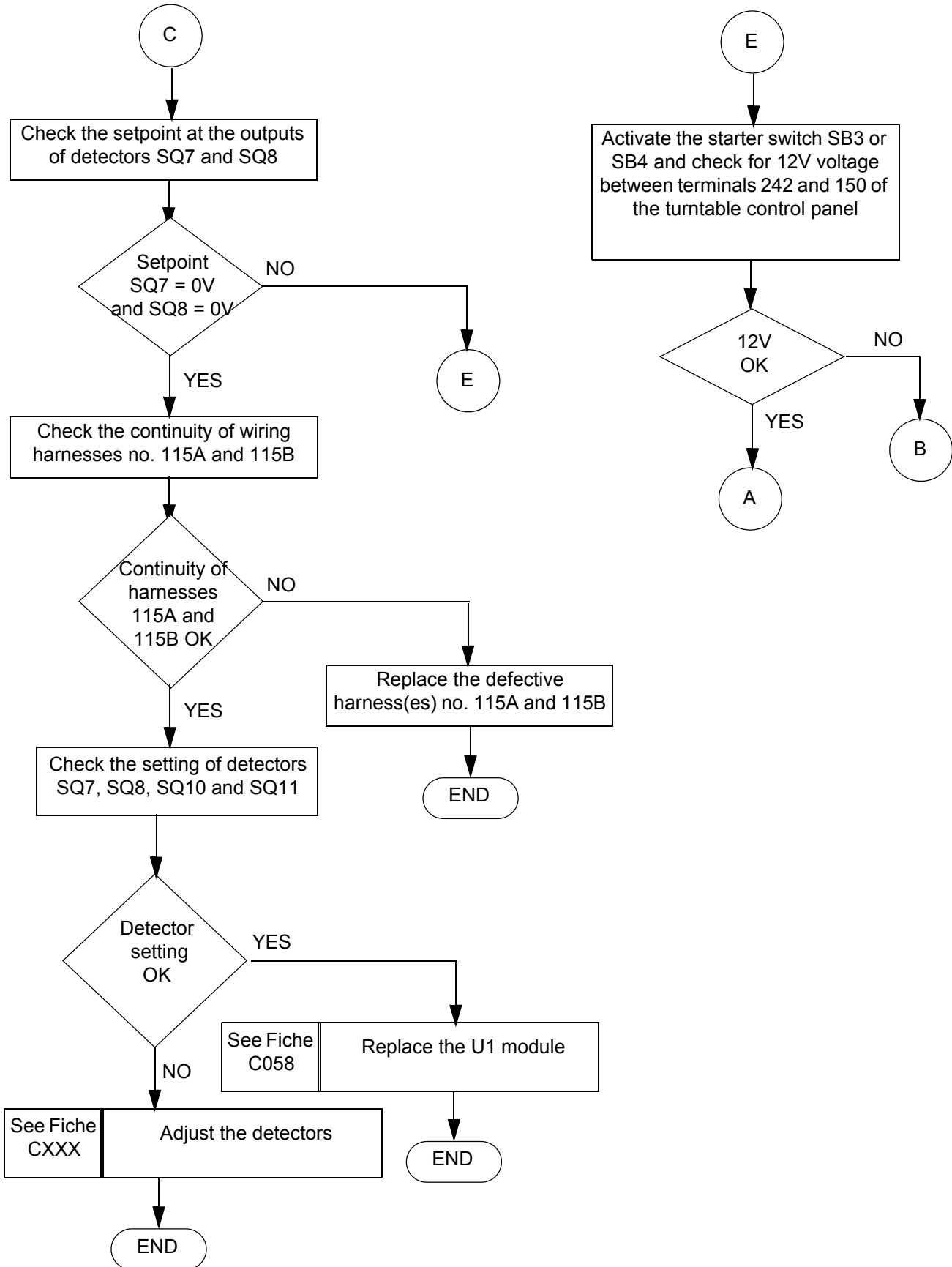

Sheet DP066	BREAKDOWN DETECTION FLOW CHART	Folio 3/4
	THE MOTOR DOES NOT START, THE STARTER IS ACTIVATED	

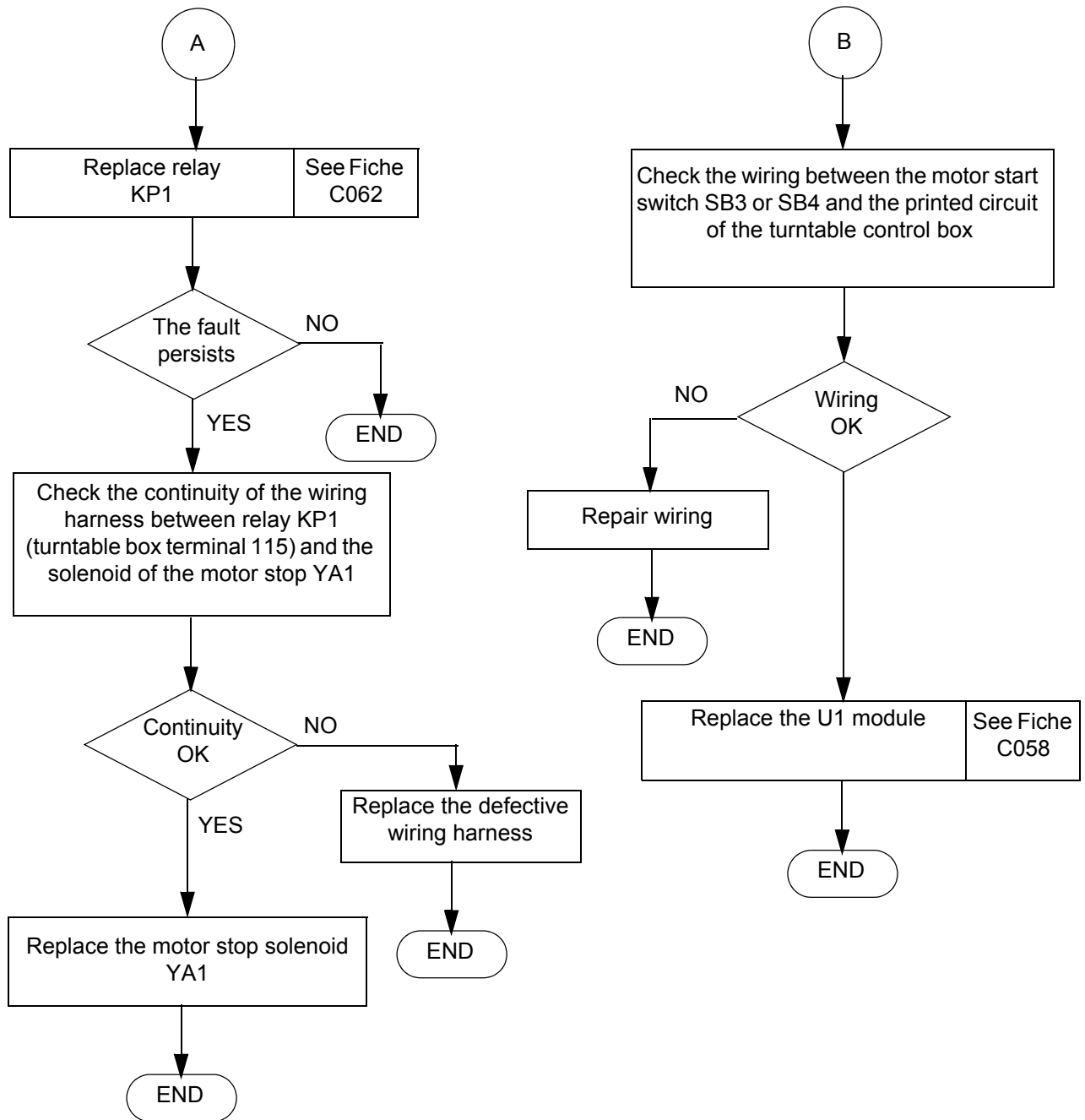

Sheet DP066	BREAKDOWN DETECTION FLOW CHART	Folio 4/4
	THE MOTOR DOES NOT START, THE STARTER IS ACTIVATED	

Sheet DP067	BREAKDOWN DETECTION FLOW CHART	Folio 1/6
	NO TELESCOPING MOVEMENT (OUT AND/OR IN) FROM THE PLATFORM (OR TURNTABLE) CONTROL PANEL	

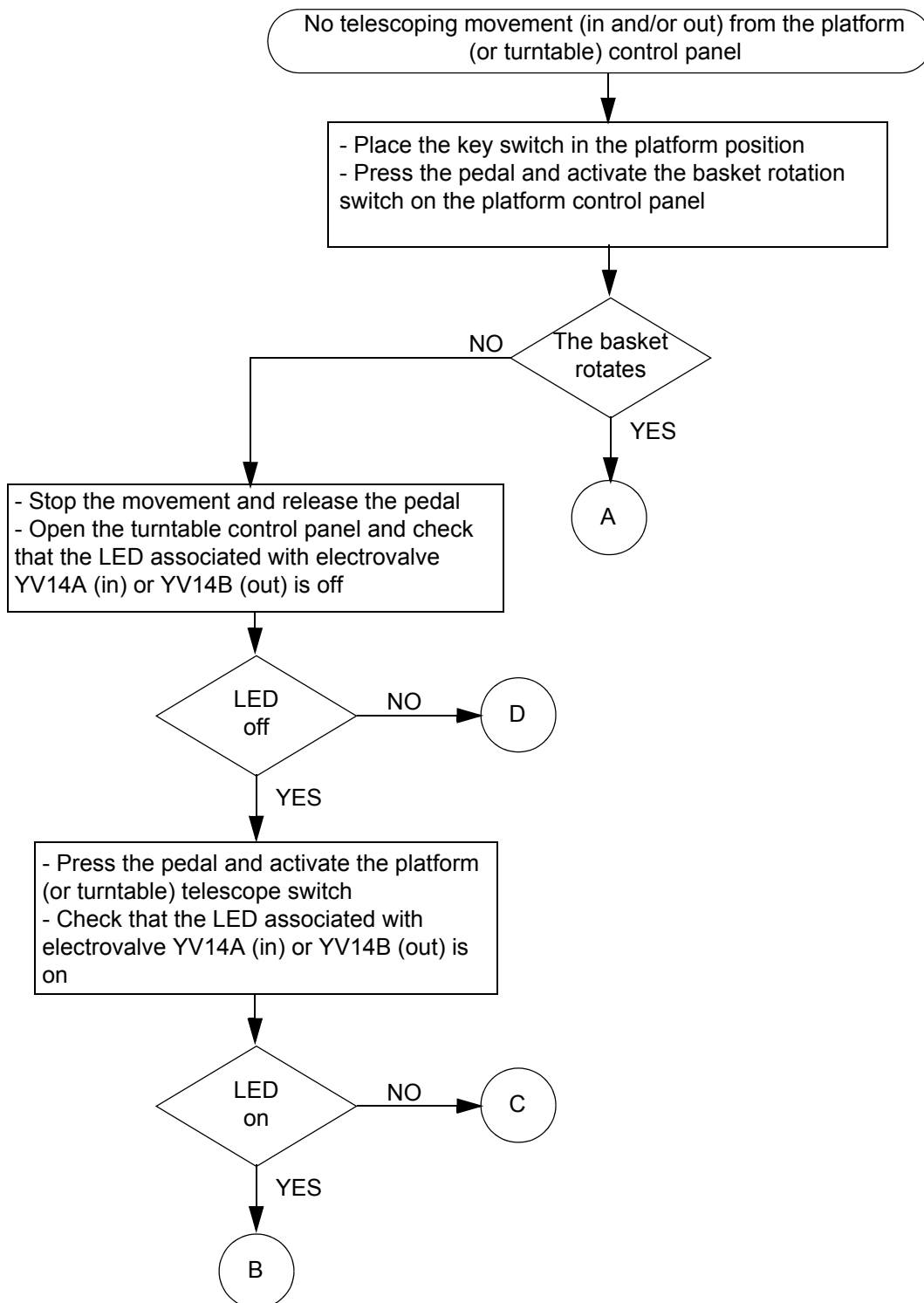

Sheet DP067	BREAKDOWN DETECTION FLOW CHART	Folio 2/6
	NO TELESCOPING MOVEMENT (OUT AND/OR IN) FROM THE PLATFORM (OR TURNTABLE) CONTROL PANEL	

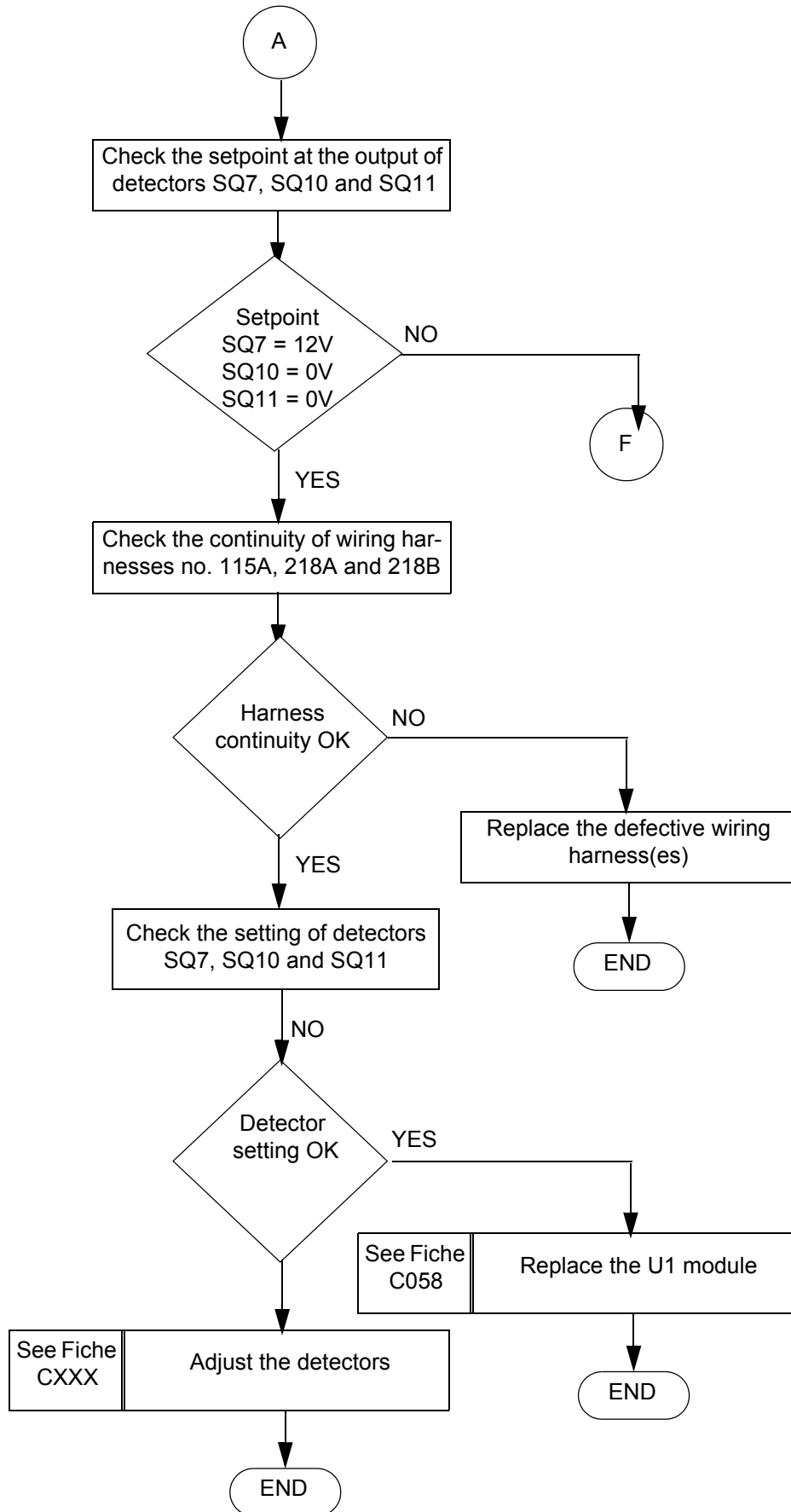

Sheet DP067	BREAKDOWN DETECTION FLOW CHART	Folio 3/6
	NO TELESCOPING MOVEMENT (OUT AND/OR IN) FROM THE PLATFORM (OR TURNTABLE) CONTROL PANEL	

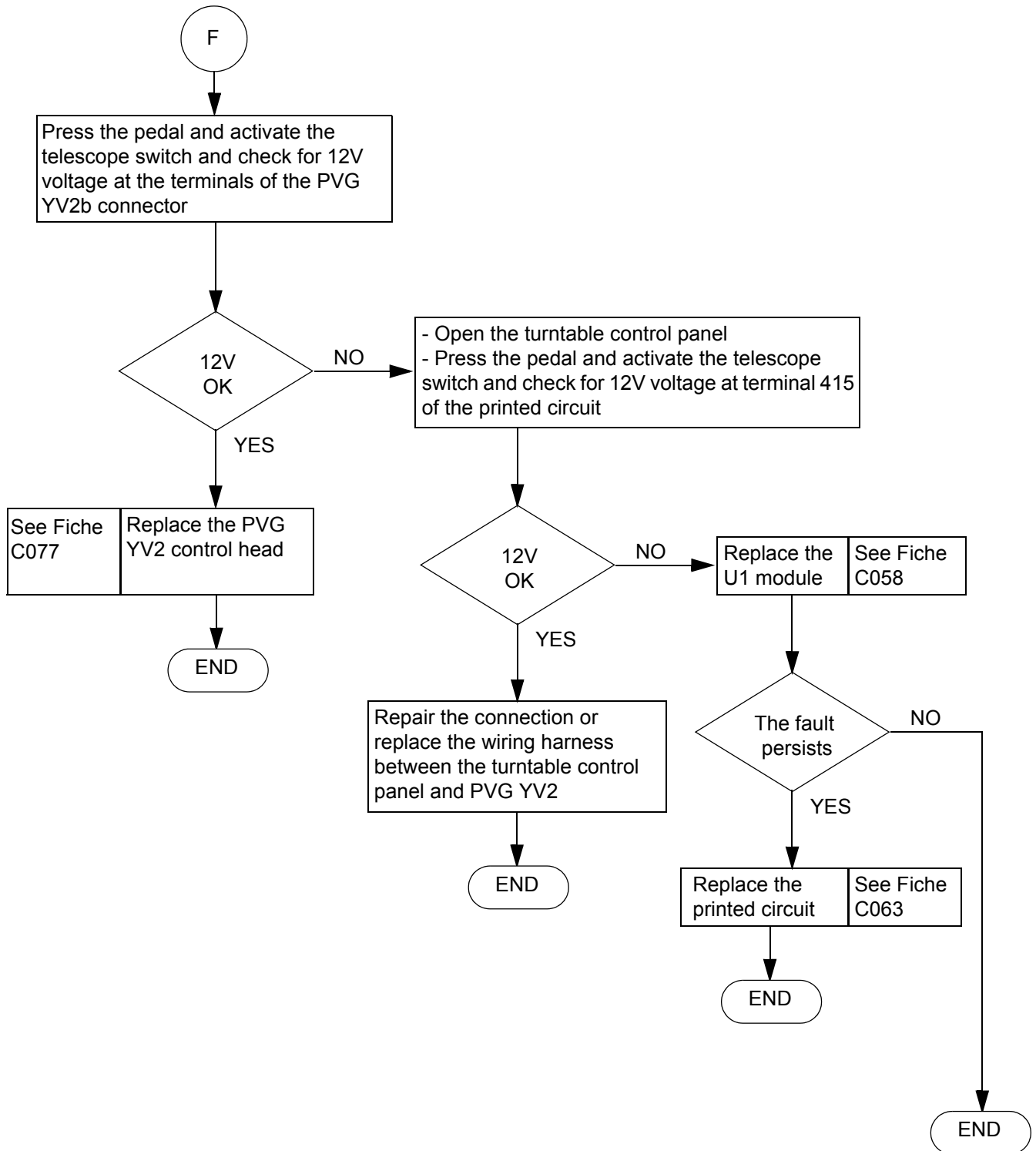

Sheet DP067	BREAKDOWN DETECTION FLOW CHART	Folio 4/6
	NO TELESCOPING MOVEMENT (OUT AND/OR IN) FROM THE PLATFORM (OR TURNTABLE) CONTROL PANEL	

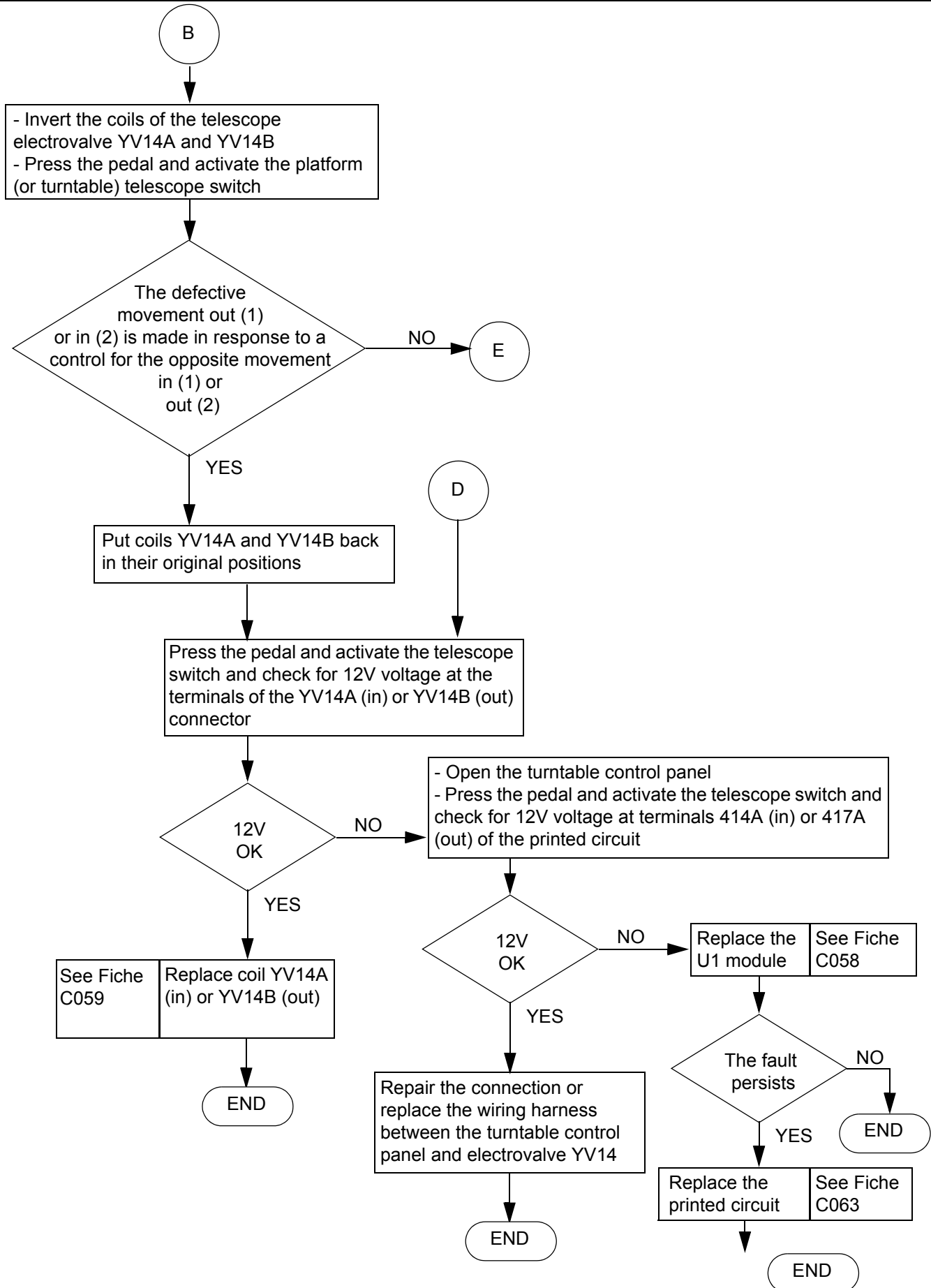

Sheet DP067	BREAKDOWN DETECTION FLOW CHART	Folio 5/6
	NO TELESCOPING MOVEMENT (OUT AND/OR IN) FROM THE PLATFORM (OR TURNTABLE) CONTROL PANEL	

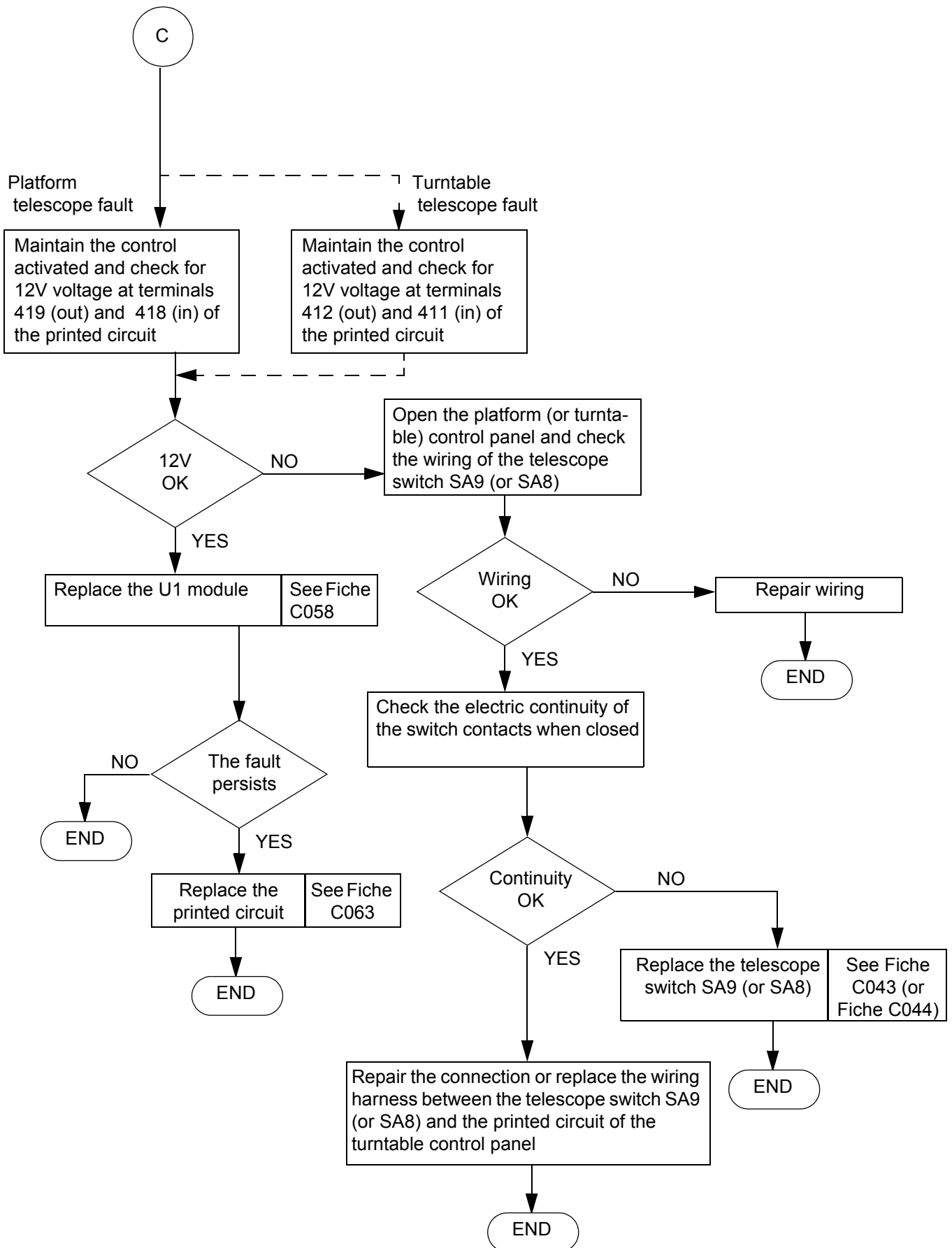

Sheet DP067	BREAKDOWN DETECTION FLOW CHART	Folio 6/6
	NO TELESCOPING MOVEMENT (OUT AND/OR IN) FROM THE PLATFORM (OR TURNTABLE) CONTROL PANEL	

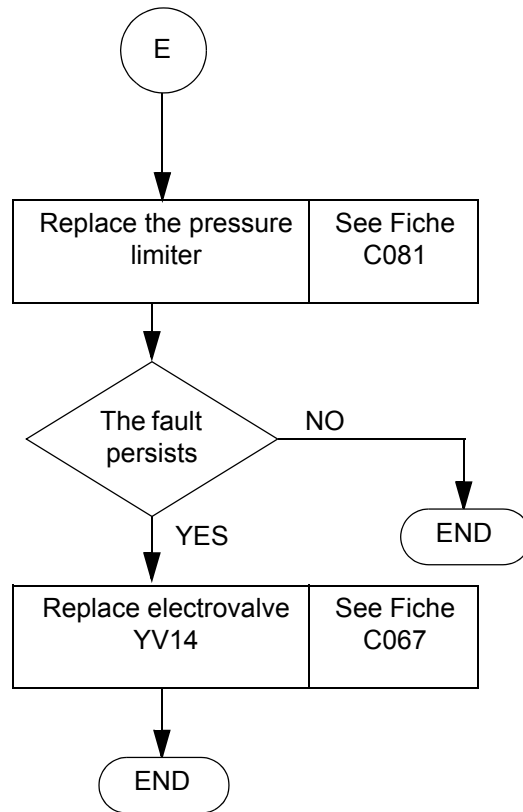

Sheet DP068	BREAKDOWN DETECTION FLOW CHART	Folio 1/4
	NO BOOM LIFTING MOVEMENT (UP AND/OR DOWN) FROM THE PLATFORM (OR TURNTABLE) CONTROL PANEL	

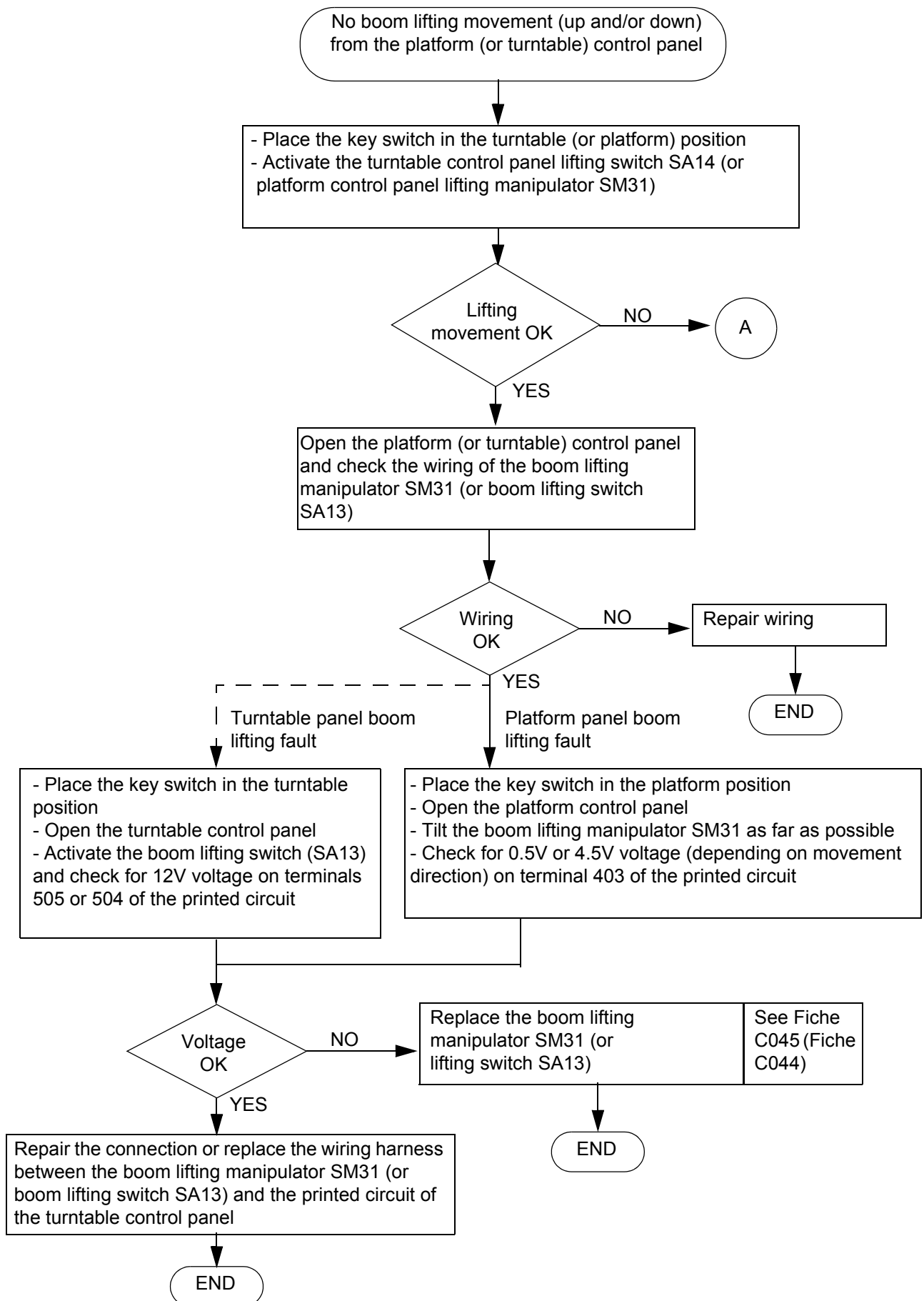

Sheet DP068	BREAKDOWN DETECTION FLOW CHART	Folio 2/4
	NO BOOM LIFTING MOVEMENT (UP AND/OR DOWN) FROM THE PLATFORM (OR TURNTABLE) CONTROL PANEL	

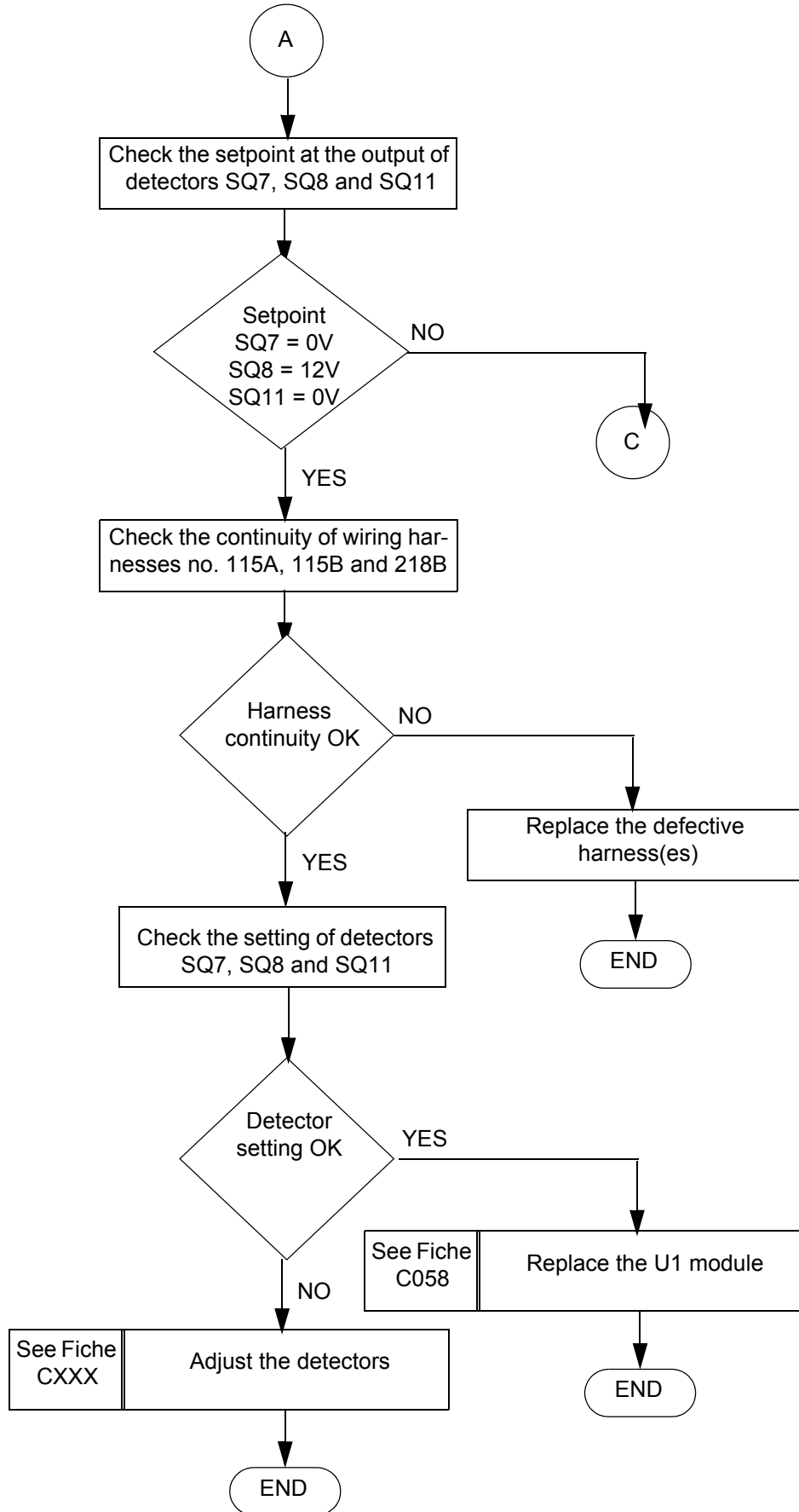

Sheet DP068	BREAKDOWN DETECTION FLOW CHART	Folio 3/4
	NO BOOM LIFTING MOVEMENT (UP AND/OR DOWN) FROM THE PLATFORM (OR TURNTABLE) CONTROL PANEL	

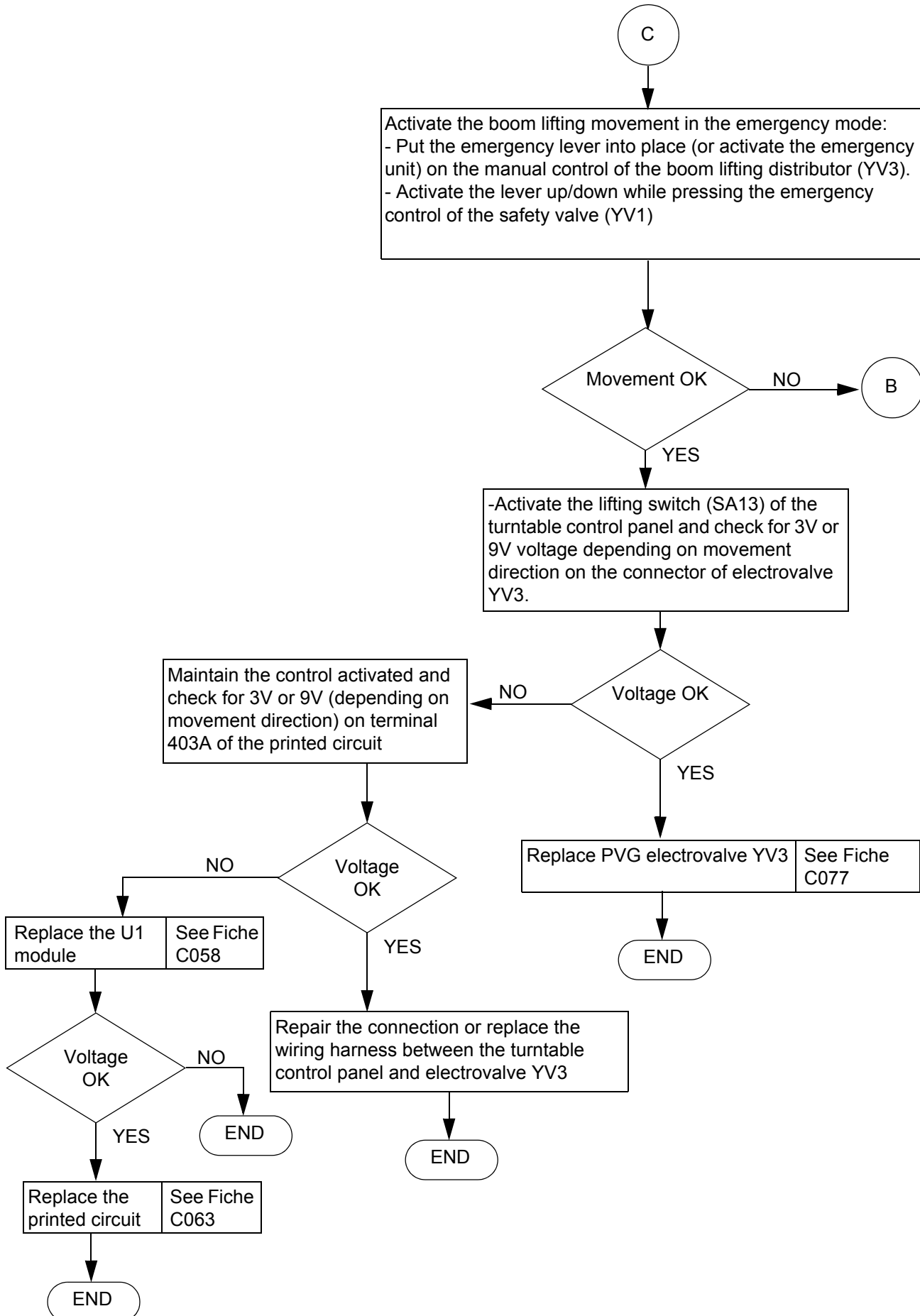

Sheet DP068	BREAKDOWN DETECTION FLOW CHART	Folio 4/4
	NO BOOM LIFTING MOVEMENT (UP AND/OR DOWN) FROM THE PLATFORM (OR TURNTABLE) CONTROL PANEL	

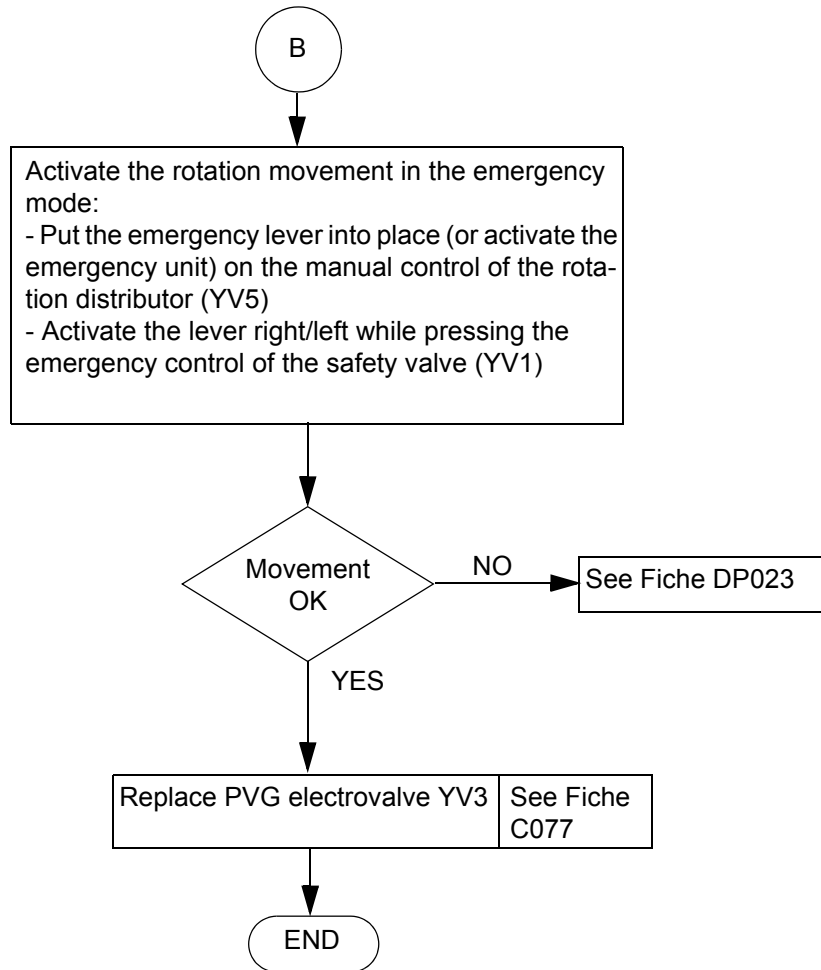

Sheet DP069	BREAKDOWN DETECTION FLOW CHART	Folio 1/4
	MACHINE TRAVEL SPEED DOES NOT CORRESPOND TO THE SELECTOR	

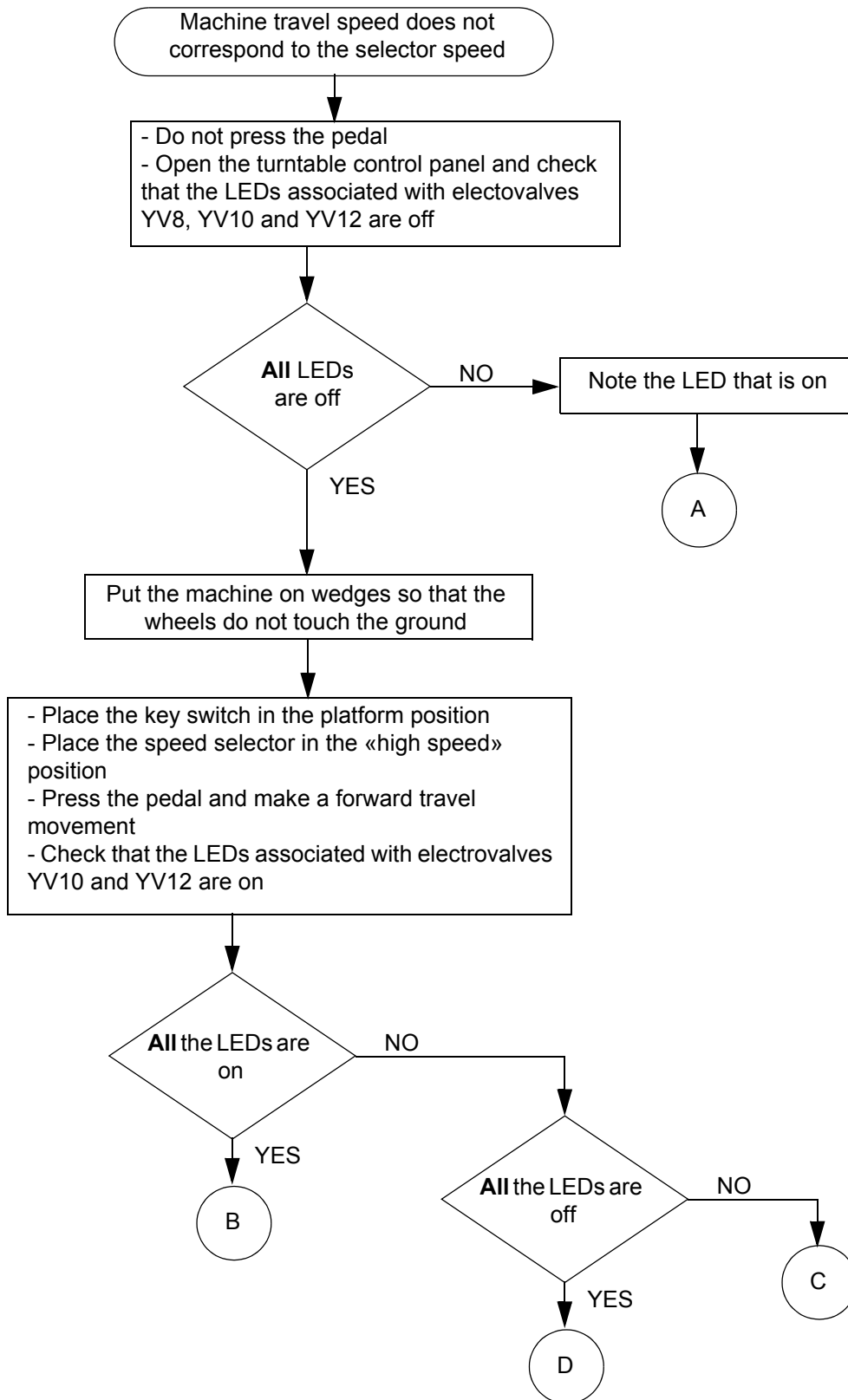

Sheet DP069	BREAKDOWN DETECTION FLOW CHART	Folio 2/4
	MACHINE TRAVEL SPEED DOES NOT CORRESPOND TO THE SELECTOR	

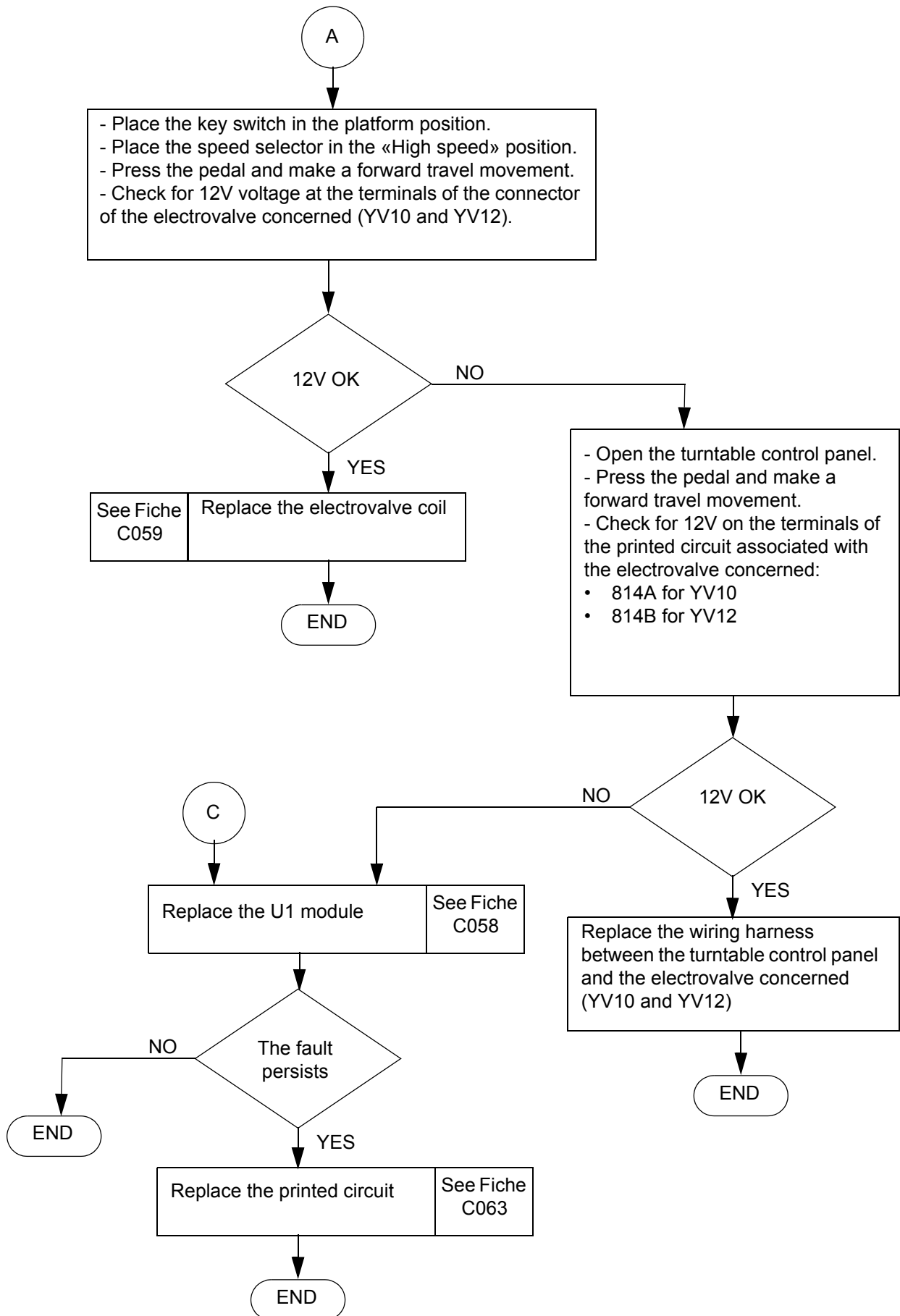

Sheet DP069	BREAKDOWN DETECTION FLOW CHART	Folio 3/4
	MACHINE TRAVEL SPEED DOES NOT CORRESPOND TO THE SELECTOR	

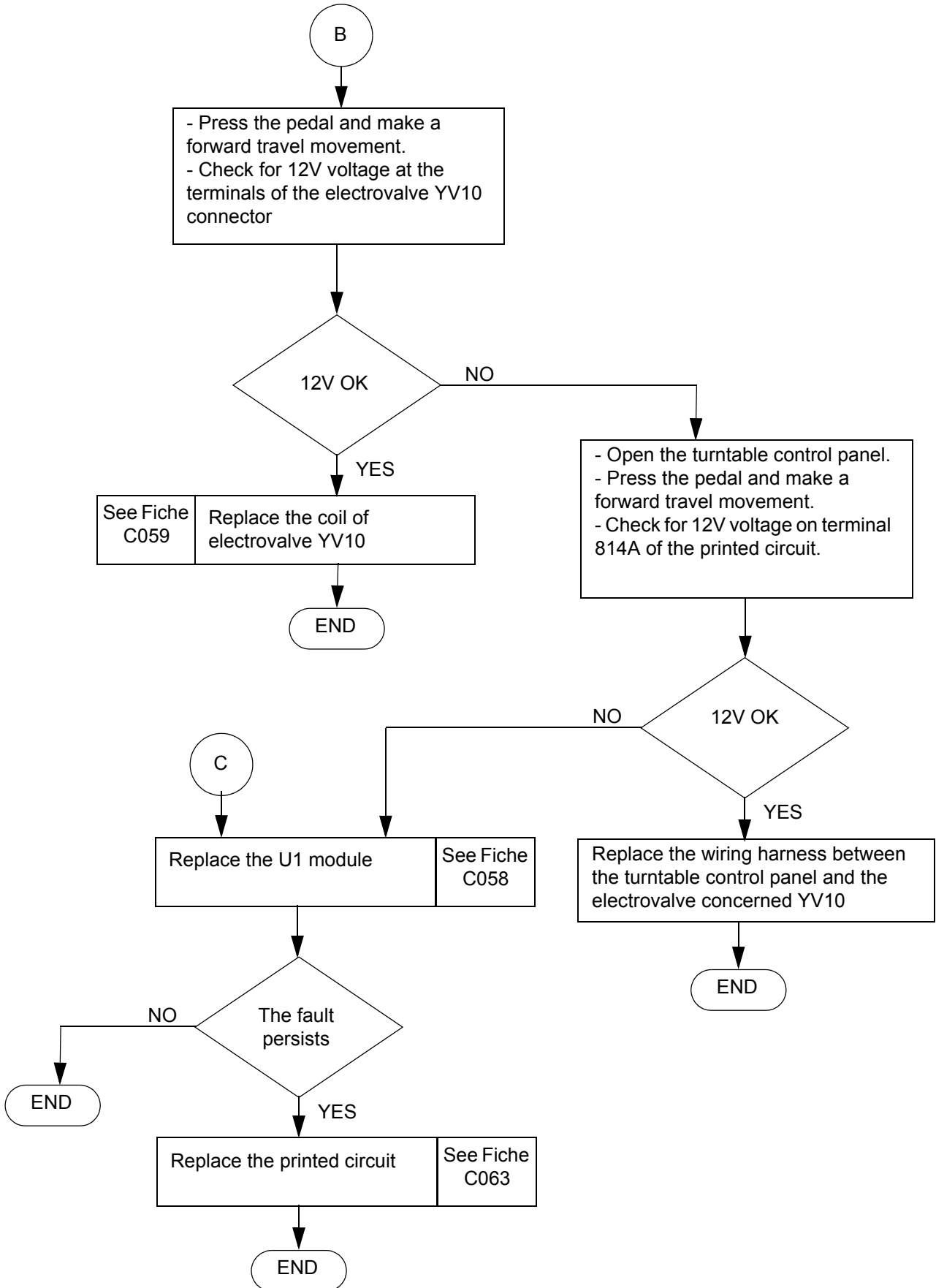

Sheet DP069	BREAKDOWN DETECTION FLOW CHART	Folio 4/4
	MACHINE TRAVEL SPEED DOES NOT CORRESPOND TO THE SELECTOR	

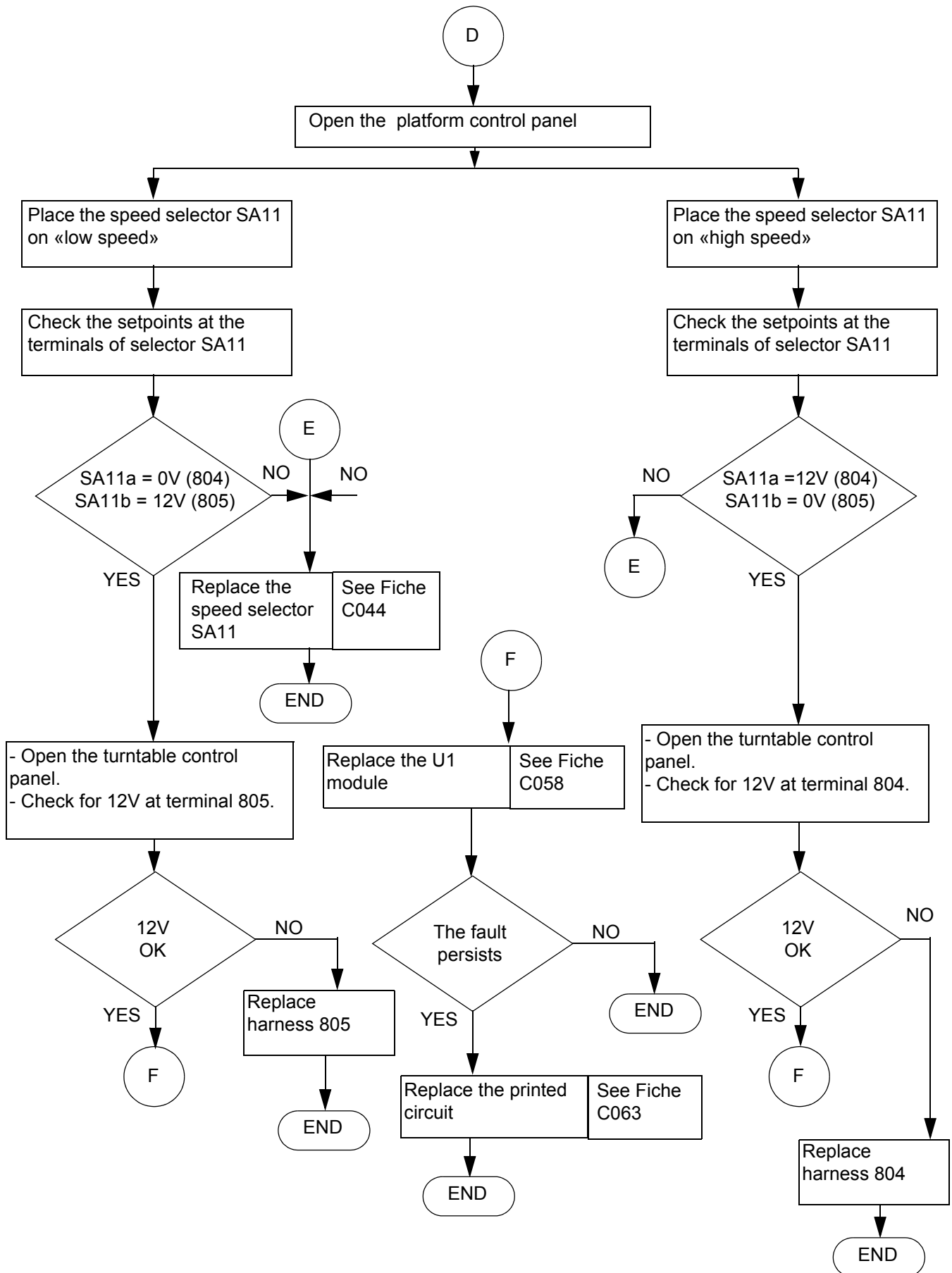

Sheet DP070	BREAKDOWN DETECTION FLOW CHART	Folio 1/1
	SUDDEN STOP OF TRAVEL MOVEMENT DURING A PLATFORM LIFTING OPERATION	

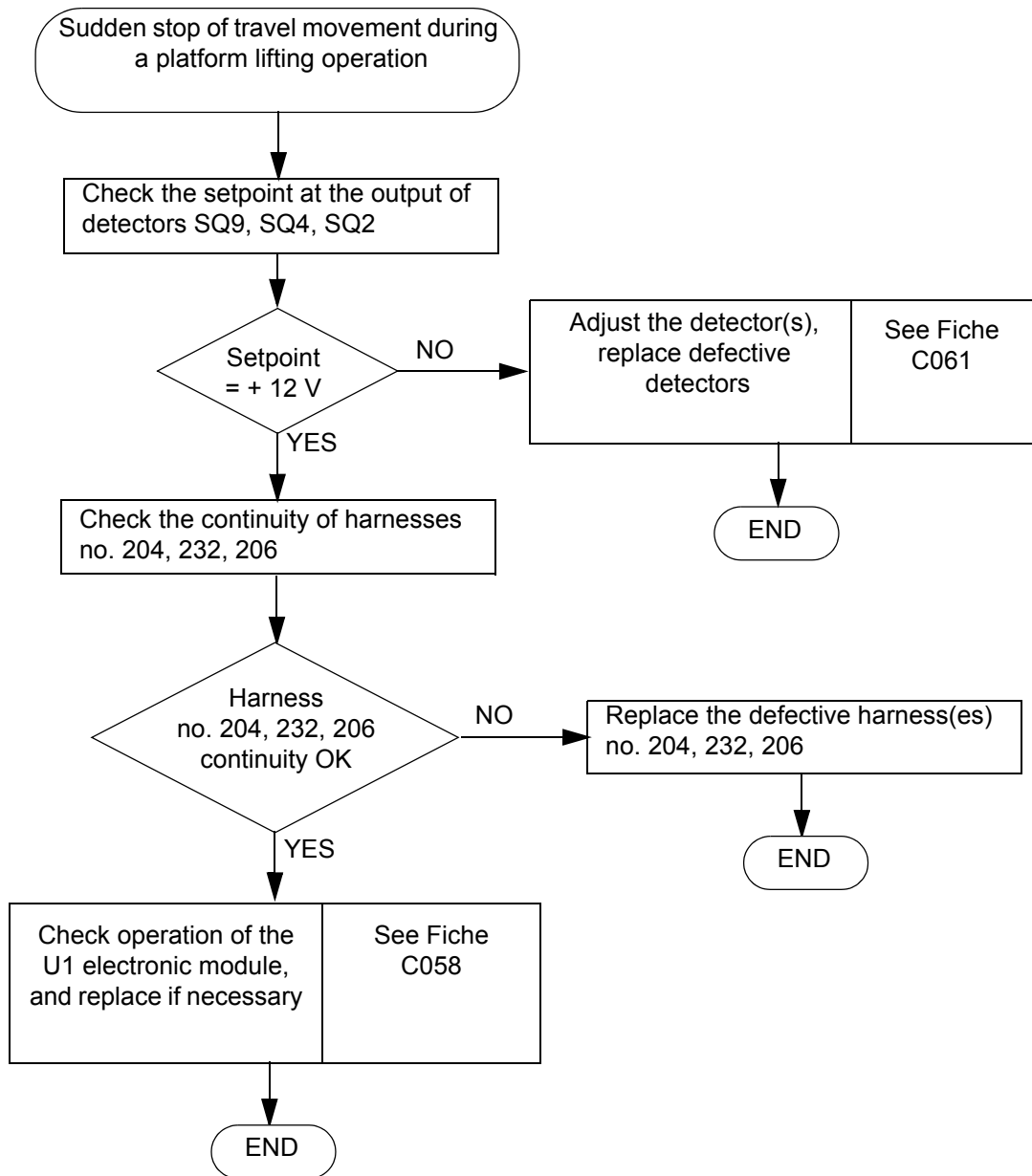

Sheet DP071	BREAKDOWN DETECTION FLOW CHART	Folio 1/2
	ONLY TRAVEL MICRO-SPEED REMAINS AVAILABLE ON THE MACHINE REGARDLESS OF THE SPEED SELECTED	

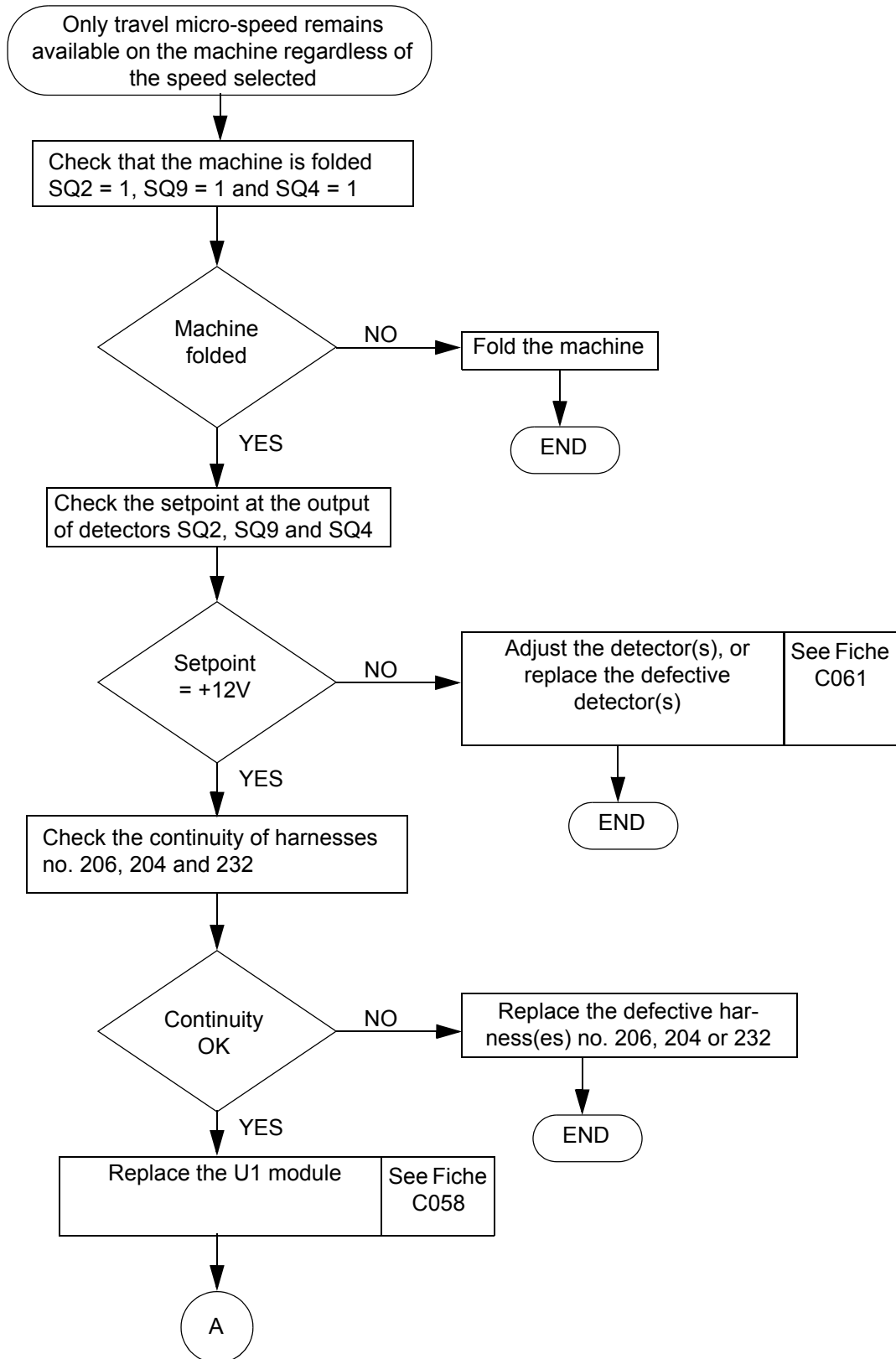

Sheet DP071	BREAKDOWN DETECTION FLOW CHART	Folio 2/2
	ONLY TRAVEL MICRO-SPEED REMAINS AVAILABLE ON THE MACHINE REGARDLESS OF THE SPEED SELECTED	

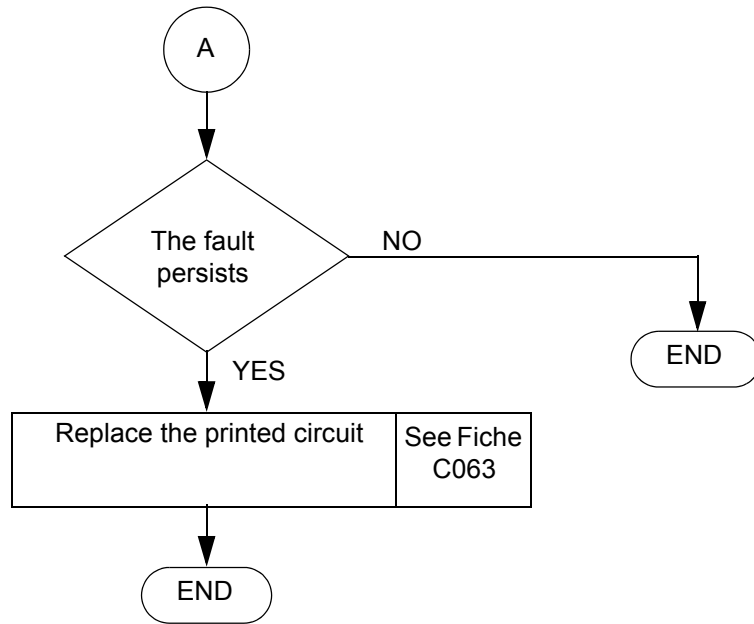

15 - CORRECTIVE MAINTENANCE PROCEDURES

List of corrective maintenance sheets:

<i>Sheet no.</i>	<i>Description</i>
SHEET C010	Changing a hose
SHEET C034	Changing a wheel
SHEET C038	Changing the steering cylinder
SHEET C039	Changing the tilt sensor
SHEET C040	Changing the horn
SHEET C041	Changing the tilt sensor buzzer
SHEET C043	Changing an electric component on the top control panel
SHEET C044	Changing an electric component on the bottom control panel
SHEET C045	Changing a manipulator
SHEET C046	Changing the starter battery
SHEET C047	Changing a cover gas spring
SHEET C052	Changing the basket rotation hydraulic motor
SHEET C053	Changing the basket
SHEET C054	Changing a weighing system rolling bearing
SHEET C056	Changing the hydraulic filter
SHEET C058	Changing the u1 electronic module
SHEET C059	Changing a coil
SHEET C062	Changing a relay
SHEET C063	Changing the printed circuit
SHEET C064	Changing the fail-safe pedal
SHEET C067	Changing an electrovalve
SHEET C068	Changing the double balancing valve of the rotation function
SHEET C069	Dismantling / re-assembling the jib
SHEET C079	Changing a flow separator
SHEET C082	Changing a balancing valve for the compensation function
SHEET C083	Changing a double flow limiter for the compensation function
SHEET C084	Changing a non-return valve on the steering hydraulic block
SHEET C085	Changing a steering pivot on a non-drive wheel
SHEET C086	Dismantling and re-assembling the steering system
SHEET C087	Changing the steering cylinder
SHEET C091	Changing the hydraulic pump
SHEET C092	Changing the hydraulic block (travel / on-off movement / steering)
SHEET C093	Changing the distribution hydraulic block
SHEET C094	Intrinsic dismantling / re-assembly of the distribution hydraulic block

<i>Sheet no.</i>	<i>Description</i>
SHEET C097	Changing a turntable cover
SHEET C099	Changing the turntable rotation hydraulic motor
SHEET C100	Changing the swing joint assembly
SHEET C104	Changing the basket rotation gearing
SHEET C106	Changing the slew ring
SHEET C108	Changing a control unit of the distribution block
SHEET C109	Changing the emergency electropump unit
SHEET C114	Changing the emergency hydraulic circuit pressure limiter
SHEET C115	Changing the jib cylinder
SHEET C117	Changing the turntable rotation reducing gear
SHEET C132	Changing a turntable cover
SHEET C133	Changing the thermal motor
SHEET C134	Changing the counterweights

Sheet C010	CORRECTIVE MAINTENANCE SHEET	Folio 1/1
	CHANGING A HOSE	

 **Caution!**
Ensure that the oil is not too hot.

 **Caution!**
Use a container to collect oil to prevent pollution of the environment.

1 - Preliminary operations

- Put the machine in the maintenance configuration (see corresponding paragraph).
- Switch off electric power (see corresponding paragraph).
- Close the shut-off valve, if any; if not, empty the hydraulic tank.

2 - Removing a hose

- Disconnect the hose from the equipment to which it is connected.

NB: *Unscrew the hose slowly to release residual hydraulic pressure.*

- Protect the holes of the equipment using caps.

3 - Installing a hose

- Reconnect a new hydraulic hose.
- Put the machine back into the operational configuration.
- Make several movements using the hose to purge the hydraulic circuit.
- Check the level in the hydraulic oil tank.

Sheet C034	CORRECTIVE MAINTENANCE SHEET	Folio 1/1
	CHANGING A WHEEL	

4 - Preliminary operations

- Put the machine in the maintenance configuration (see corresponding paragraph).
- Switch off electric power (see corresponding paragraph).

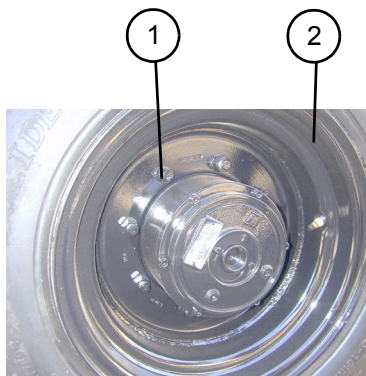
**5 - Removing a wheel**

- Unblock (without completely unscrewing) the fixing screws (1) of the wheel to be removed.
- Raise the machine using a jack or hoist.
- Remove the fixing screws (1) from the wheel and remove the wheel (2).

6 - Installing a wheel

- Put a new wheel into place and put back the fixing screws.
- Put the machine on the ground.
- Tighten the fixing screws to the recommended torque (see tightening torque value table).
- Put the machine back into the operational configuration.

**Caution!**

Use a container to collect oil to prevent pollution of the environment.

**Caution!**

It is essential to put the component in slings before dismantling/re-assembling it.

Sheet C038	CORRECTIVE MAINTENANCE SHEET	Folio 1/1
	CHANGING THE STEERING CYLINDER	

 **Caution!**
Ensure that the oil is not too hot.

 **Caution!**
Use a container to collect oil to prevent pollution of the environment.

 **Caution!**
It is essential to put the component in slings before dismantling/re-assembling it.

7 - Preliminary operations

- Put the machine in the maintenance configuration (see corresponding paragraph).
- Switch off electric power (see corresponding paragraph).

2 - Removing the steering cylinder

- Open the upper chassis cover.
- Mark and disconnect the two hoses (2) of the steering cylinder (1).

NB: *Unscrew the hoses slowly to release residual hydraulic pressure.*

- Put caps on the hoses.
- Put the cylinder in slings.
- Remove the Nylstop nuts (4) then remove the two fastening pins (3) from the steering cylinder.
- Remove the steering cylinder.

3 - Installing the steering cylinder

- Put a new steering cylinder into place.
- Install the fastening pins and fix using new Nylstop nuts and their washers.
- Reconnect the hydraulic hoses according to the marks made during dismantling.
- Put the machine back into the operational configuration.
- Make several steering movements to purge the hydraulic circuit.
- Check the level of the hydraulic oil tank.



HA16/18 - HA46/51 JRT

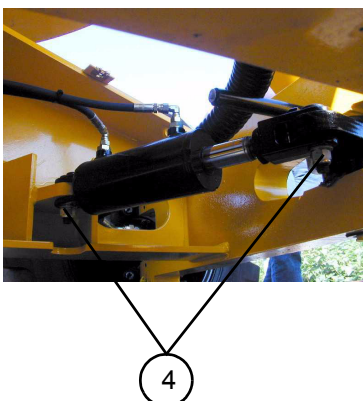

HA16/18 - HA46/51 JRT

Sheet C039	CORRECTIVE MAINTENANCE SHEET	Folio 1/1
	CHANGING THE TILT SENSOR	

 **Caution!**
Do not use the machine during maintenance operations.

1 - Preliminary operations

- Put the machine on a flat surface with zero slope.
- Put the machine into the maintenance configuration (see corresponding paragraph).
- Switch off electric power (see corresponding paragraph).

2 - Removing the tilt sensor

- Mark and disconnect the electric connections of the tilt sensor.
- Remove the tilt sensor (2) by unscrewing the fixing bolts (1).

3 - Installing the tilt sensor

- Put a new tilt sensor into place and fix using the fixing bolts (1).
- Reconnect the electric connections according to the marks made during dismantling.
- Place a spirit level on the top surface of the tilt sensor and set the adjustment screws (4) so that the tilt sensor is level.

NB: *The spirit level (3) is built into certain tilt sensors.*

- Put the machine back into the operational configuration.

4 - Tilt sensor operating test

- Extend the machine.
- Tilt the tilt sensor and check that the buzzer sounds.
- Check that after 1 or 2 seconds, extension or travel movements have been disabled.

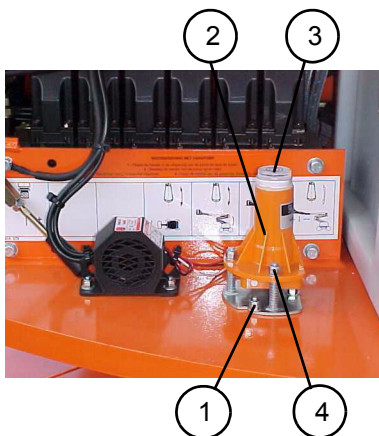

HA16/18PX - HA46/51 JRT

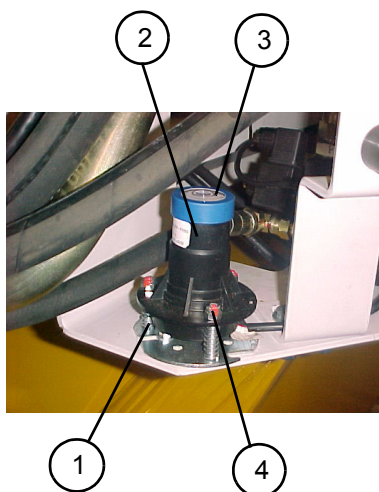

HA16/18PX New design
 HA46/51JRT New Design

 **Caution!**
The buzzer should be audible from the basket.

Sheet C040	CORRECTIVE MAINTENANCE SHEET	Folio 1/1
	CHANGING THE HORN	

 **Caution!**
Do not use the machine during maintenance operations.

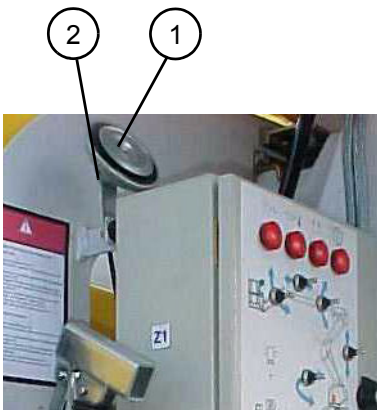

1 - Preliminary operations

- Switch off electric power (see corresponding paragraph).

2 - Removing the horn

- Mark and disconnect the electric connections from the horn (1).
- Remove the horn, by unscrewing the fixing bolts (2).

3 - Installing the horn

- Put the horn back into place and fix with the fixing bolt.
- Reconnect the electric connections according to the marks made during dismantling.

4 - Test

- Select the top control panel and switch on machine power.
- Put the machine back into the operational configuration.
- Activate the horn switch from the platform control panel and check that the horn sounds.

 **Caution!**
The horn should be audible from the basket.

Sheet C041	CORRECTIVE MAINTENANCE SHEET	Folio 1/1
	CHANGING THE TILT SENSOR BUZZER	

 **Caution!**
Do not use the machine during maintenance operations.

HA16/18PX - HA46/51JRT

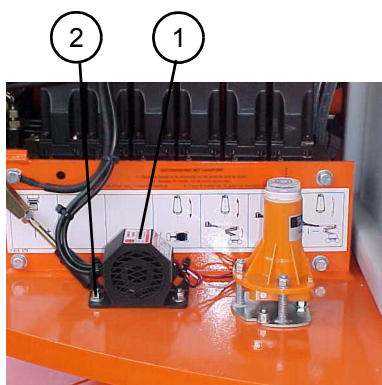

1 - Preliminary operations

- Switch off electric power (see corresponding paragraph).

2 - Removing the buzzer

- Mark and disconnect the buzzer's electric connections (1).
- Remove the buzzer by unscrewing the fixing bolts (2).

3 - Installing the buzzer

- Put the buzzer back into place and fix with the fixing bolts.
- Reconnect the electric connections according to the marks made during dismantling.

4 - Test

- Put the machine back into the operational configuration.
- Extend the machine, tilt the tilt sensor and check that the buzzer sounds.

HA16/18PX New design
 HA46/51JRT New Design

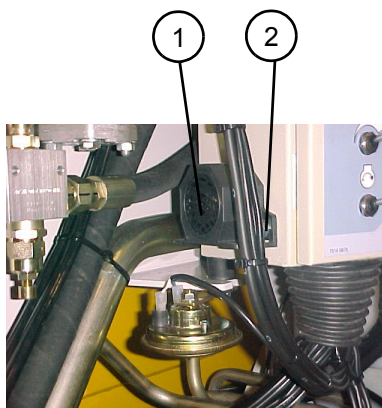

 **Caution!**
The buzzer should be audible from the basket.

Sheet C043	CORRECTIVE MAINTENANCE SHEET	Folio 1/1
	CHANGING AN ELECTRIC COMPONENT ON THE TOP CONTROL PANEL	

 **Caution!**
Do not use the machine during maintenance operations.

1 - Preliminary operations

- Put the machine in the maintenance configuration (see corresponding paragraph).
- Switch off electric power (see corresponding paragraph).
- Disconnect the «-» then «+» terminals of the starter battery.

2 - Removing a component from the top control panel

- Remove the closing plate (1) by removing the four fixing screws (4).
- Mark and disconnect the electric connections (3) of the component to be replaced (2).
- Remove the component.

3 - Installing a component in the top control panel

- Put a new component and seal into place on the front panel of the top control panel.

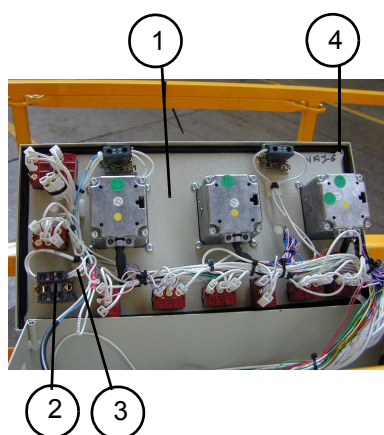

NB: *In the case of a lever switch, adjust the position of the fixing nut and counter-nut so that the switch lever's articulation pin is at the same level as the seal, to ensure tightness.*

- Reconnect the electric connections according to the marks made during dismantling.
- Fix the closing plate using the four fixing screws.
- Reconnect the « + » then « - » terminals of the battery.
- Put the machine back into the operational configuration.
- Perform the function corresponding to the replaced component to check that it works properly.

Sheet C044	CORRECTIVE MAINTENANCE SHEET	Folio 1/1
	CHANGING AN ELECTRIC COMPONENT ON THE BOTTOM CONTROL PANEL	

 **Caution!**
Do not use the machine during maintenance operations.

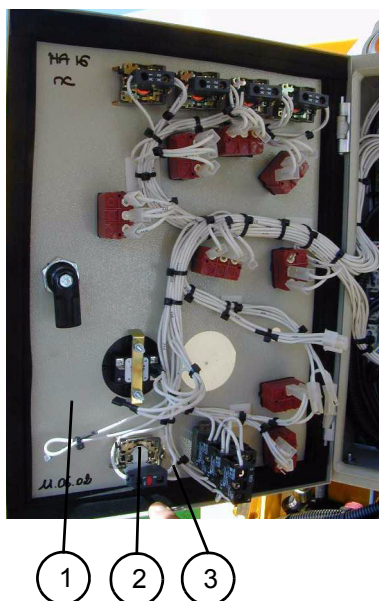

1 - Preliminary operations

- Put the machine in the maintenance configuration (see corresponding paragraph).
- Switch off electric power (see corresponding paragraph).
- Disconnect the «-» then «+» terminals to isolate the circuit.

2 - Removing a component from the bottom control panel

- Open the door of the bottom control panel (1).
- Mark and disconnect the electric connections (3) of the component to be replaced (2).
- Remove the component.

3 - Installing a component in the bottom control panel

- Put a new component and seal into place on the front panel of the bottom control panel.

NB: In the case of a lever switch, adjust the position of the fixing nut and counter-nut so that the switch lever's articulation pin is at the same level as the seal, to ensure tightness.

- Reconnect the electric connections according to the marks made during dismantling.
- Close the door of the bottom control panel.
- Reconnect the « + » then « - » terminals of the battery.

4 - Test

- Put the machine back into the operational configuration.
- Perform the function corresponding to the replaced component to check that it works properly.

Sheet C045	CORRECTIVE MAINTENANCE SHEET	Folio 1/1
	CHANGING A MANIPULATOR	

 **Caution!**
Do not use the machine during maintenance operations.

1 - Preliminary operations

- Put the machine in the maintenance configuration (see corresponding paragraph).
- Switch off electric power (see corresponding paragraph).
- Disconnect the «-» then «+» terminals to isolate the circuit.

2 - Removing a manipulator (2)

- Remove the upper panel (4) of the top control box by removing its fixing screws (1).
- Using cutters, remove the cable clamps from the defective manipulator wires.
- Carefully mark the positions of the different manipulator wires (3) on the top control panel connector.
- Disconnect the wires from the top control panel plug.
- Disconnect the positive wires 211 from the switches, and then the negative wire.
- Remove the fixing screws (5) from the manipulator and take the manipulator out of the box.

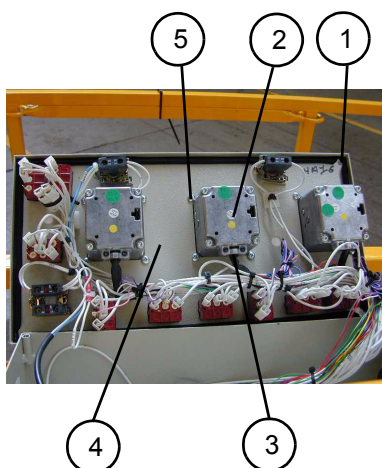

3 - Installing a manipulator

- Place the replacement manipulator in position and put back the fixing screws (5).
- Put back the wires (3) in the cable strand and fasten the strand using plastic clamps.
- Fit male reference contacts to the ends of the wires (3).
- Connect the wires in the plug according to the marks made during dismantling.
- Re-connect the supply wires 211 and then the negative wire.
- Put back the upper panel (4) of the box and fix using screws (1).
- Re-connect the « + » then « - » terminals of the battery.
- Put the machine back into its operational configuration.
- Make several movements controlled from the basket to test manipulator operation.

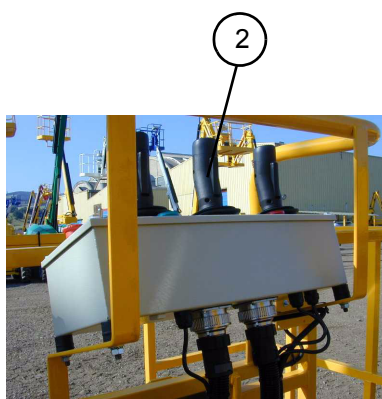

Sheet C046	CORRECTIVE MAINTENANCE SHEET	Folio 1/1
	CHANGING THE STARTER BATTERY	

 **Caution!**
Wear protective goggles and gloves for any operation on the batteries.

1 - Preliminary operations

- Put the machine in the maintenance configuration (see corresponding paragraph).
- Switch off electric power (see corresponding paragraph).

2 - Removing the starter battery

- Disconnect the « - » then « + » terminals (1) of the battery (3).
- Remove the fixing screws from the battery fixing tab and remove the fixing tab (2).
- Remove the battery.

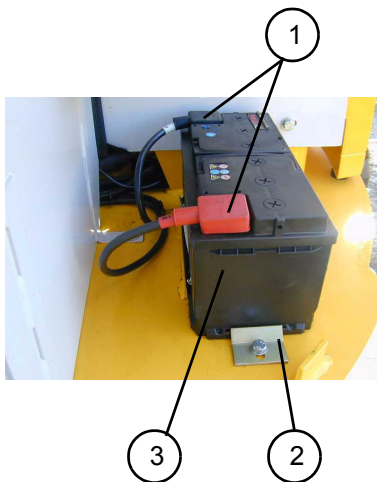

3 - Installing the starter battery

- Put a new battery into place.
- Put back the fixing tab and secure with the fixing screw equipped with a new toothed washer.
- Re-connect the « + » then « - » terminals of the battery and lubricate them to improve contact.
- Put the machine back into its operational configuration.
- Start the machine to check that the battery works properly.

Sheet C047	CORRECTIVE MAINTENANCE SHEET	Folio 1/1
	CHANGING A COVER GAS SPRING	

Caution!
Do not use the machine during maintenance operations.

HA16/18PX - HA46/51JRT

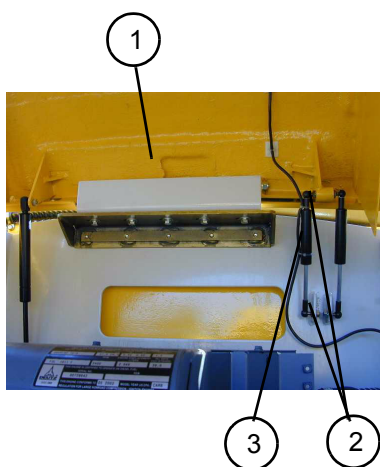

1 - Preliminary operations

- Put the machine in the maintenance configuration (see corresponding paragraph).
- Switch off electric power (see corresponding paragraph).

2 - Removing a gas spring

- Open the cover (1) concerned.
- Put the cover in slings.
- Remove the fixing nuts and washers (2) at both ends of the gas spring (3).

3 - Installing a gas spring

- Put a new gas spring into place and fix at both ends using the fixing nuts and washers.
- Put the machine back into the operational configuration.
- Check that the cover opens and closes correctly.

HA16/18 PX New design
 HA46/51JRT New Design

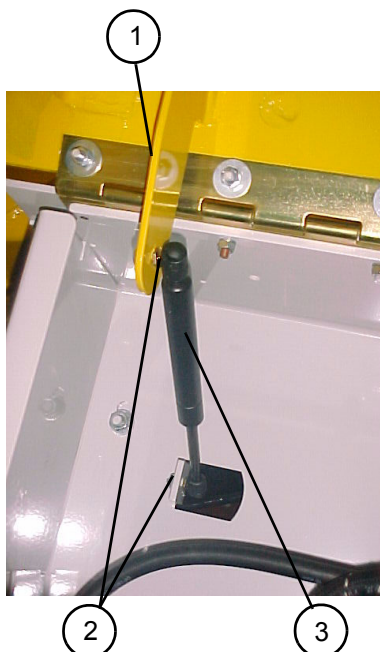

Sheet C052	CORRECTIVE MAINTENANCE SHEET	Folio 1/1
	CHANGING THE BASKET ROTATION HYDRAULIC MOTOR	

 **Caution!**
Ensure that the oil is not too hot.

 **Caution!**
Use a container to collect oil to prevent pollution of the environment.

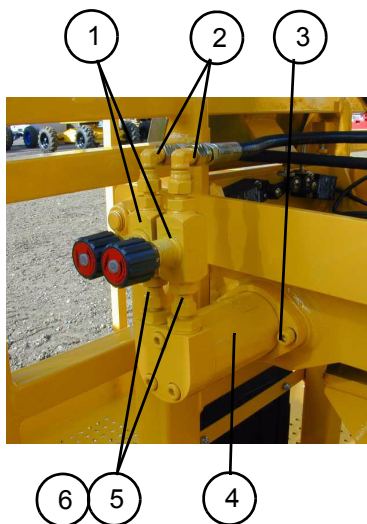

1 - Preliminary operations

- Put the machine in the maintenance configuration (see corresponding paragraph).
- Switch off electric power (see corresponding paragraph).

2 - Removing the hydraulic motor

- Mark and disconnect the hoses (2) from the hydraulic motor (4).

NB: *Unscrew the hoses slowly to release residual hydraulic pressure.*

- Fit caps to the hoses.
- Remove the flow limiters (1) by unscrewing the unions (5) and adapters (6).
- Remove the hydraulic motor by unscrewing its fixing screws (3).

3 - Installing the hydraulic motor

- Replace the flow limiters if necessary.
- Put a new hydraulic motor into place.
- Fix the hydraulic motor using fixing screws equipped with new grower washers.
- Screw the unions, adapters and flow limiters onto the motor.
- Reconnect the hydraulic hoses according to the marks made during dismantling (see table of tightening torque values).
- Put the machine back into the operational configuration.
- Make several platform rotation movements to purge the hydraulic circuit and adjust rotation speed using the flow limiter adjustment buttons (see Table of adjustment times).
- Check the level of the hydraulic oil tank.

Sheet C053	CORRECTIVE MAINTENANCE SHEET	Folio 1/3
	CHANGING THE BASKET	



Caution!

It is essential to put the component in slings before dismantling/re-assembling it.

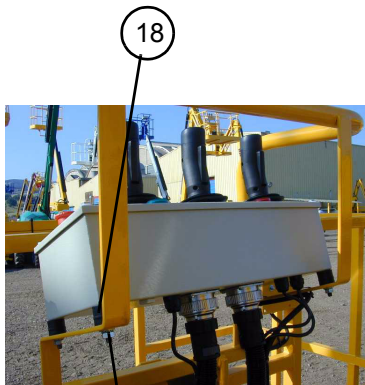

18

17



19

1 - Preliminary operations

- Put the machine in the maintenance configuration (see corresponding paragraph).
- Switch off electric power (see corresponding paragraph).
- Disconnect the « - » then « + » terminals of the starter battery.

2 - Removing the platform

- Disconnect the platform control panel electric wiring harness.
- Remove the control panel fixing screws (17).
- Remove the control panel and its silent blocks (18).
- Remove the platform's electric plug (19), if any, by unscrewing its fixing bolts.
- Put the platform in slings.
- Remove the pre-stressing stop by unscrewing the screw (1) and nut (2).

Upper part

- Remove the Nylstop nut (3) and its washer (4) on the platform side.
- Remove the stop pad (5) on the platform side.
- Remove the weighing articulation pin (6).

Lower part

- Remove the lower pivot pin (7) by removing its fixing screws (8) and washer (9).
- Remove the platform and retain the ball (10), the nylatron washer (11) and the stop (12).
- If necessary, unscrew the pre-stressing nut totally (13) as a safety measure, before performing any operation on the platform.

3 - Installing the platform

- Check the condition of the elastic parts and wearing parts, and replace if necessary (spring washers (14), collar rings (15), ring (16), nylatron washer (11), control panel silent blocks, circlips).

Lower part

- If necessary, adjust the pre-stressing system by tightening the pre-stressing nut (13), so that the washers are 108 mm high (see figure 3).
- Put the platform into place, taking care to put the ball (10), nylatron washer (11) and stop (12) in the right places.
- Lubricate the bore and put the lower pivot (7) into place. Fix using the fixing screw (8) and washer (9).

NB: *Only use lubricants recommended by the manufacturer.*

Upper part

- Lubricate then put back the weighing articulation pin (6).
- Put back the stop tab (5).
- Install the Nylstop nut (3) and its washer (4).
- Adjust the stop for the pre-stressing system by tightening the screw (1) and the nut (2).
- Put the control panel into place on its silent blocks and fix using the screws equipped with new washers.
- Reconnect the control panel wiring harness.

Sheet C053	CORRECTIVE MAINTENANCE SHEET	Folio 2/3
	CHANGING THE BASKET	

- If necessary, put the platform's electric plug back into place and fix using its fixing bolts equipped with new toothed washers.
- Reconnect the « + » then « - » terminals of the starter battery.
- Put the machine back into the operational configuration.
- Adjust the weighing contactors (see corresponding sheet).

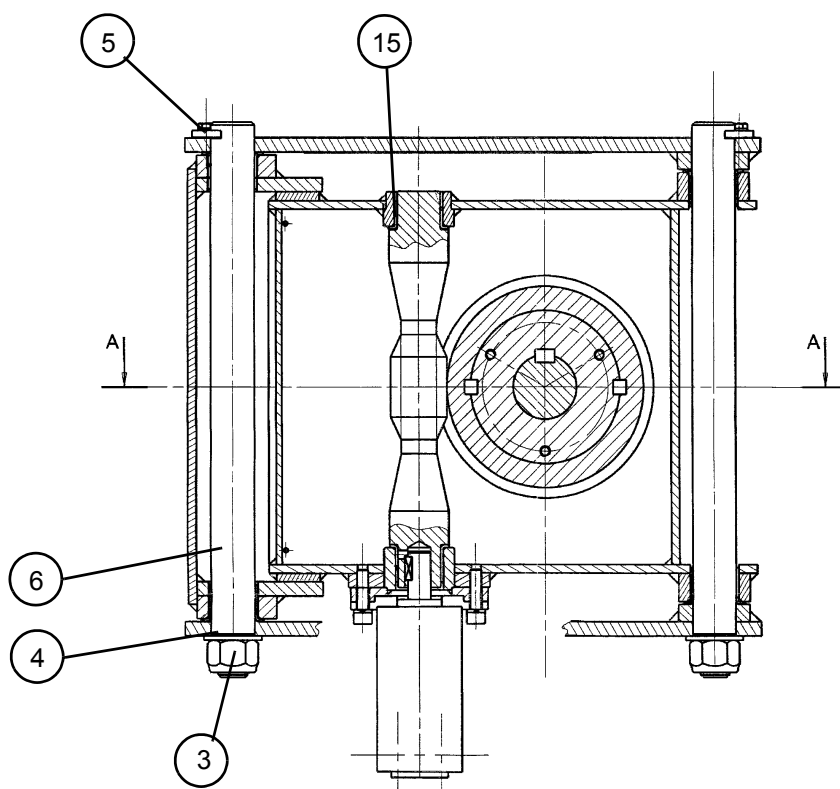
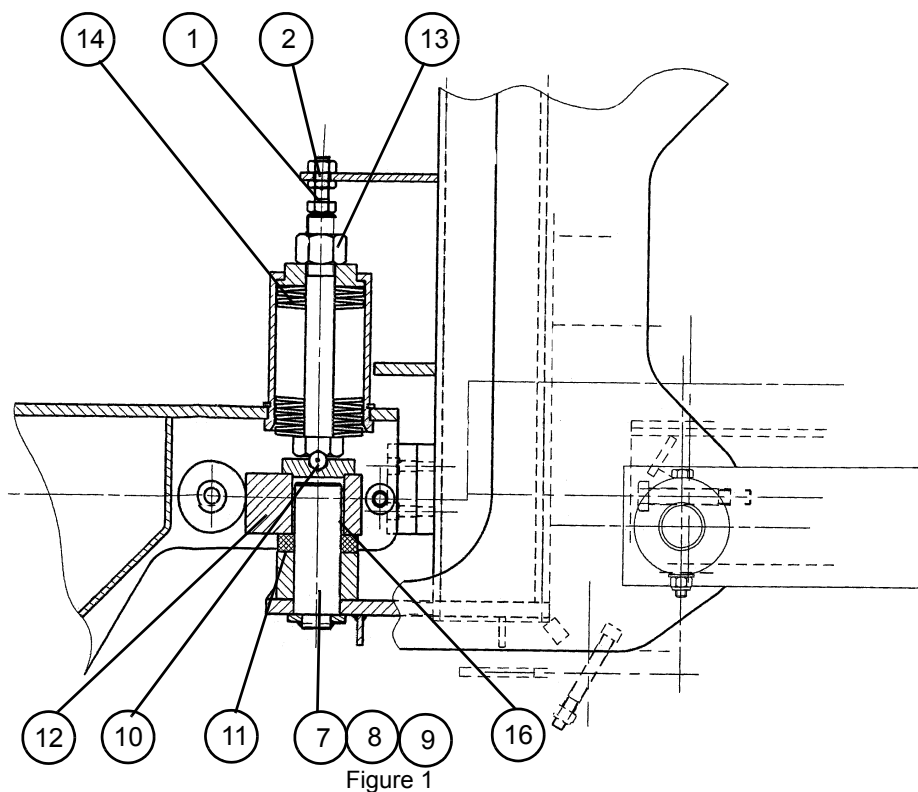

Sheet C053	CORRECTIVE MAINTENANCE SHEET	Folio 3/3
	CHANGING THE BASKET	

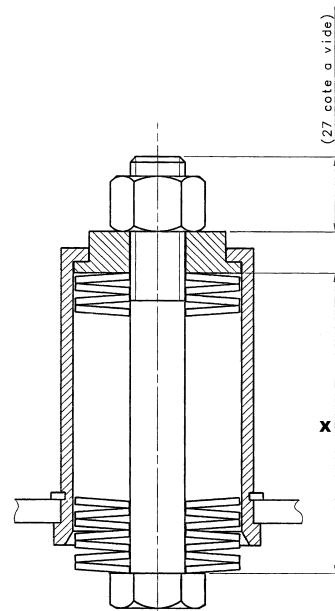

Figure 3

X =

HA16/18PX - HA46/51JRT = 108 mm / 4.25 in

H21T - HB62 = 103 mm / 4.055 in

H23T/TP - H25TP - HB68J - HB76J = 108 mm / 4.25 in

Sheet C054	CORRECTIVE MAINTENANCE SHEET	Folio 1/1
	CHANGING A WEIGHING SYSTEM ROLLING BEARING	

1 - Preliminary operations

- Put the machine in the maintenance configuration (see corresponding paragraph).
- Switch off electric power (see corresponding paragraph).
- Remove the basket (see corresponding sheet).

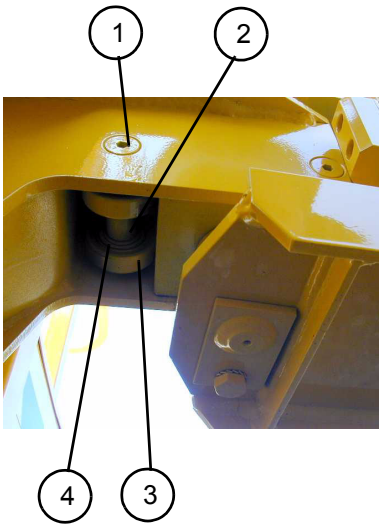

2 - Removing the rolling bearing

- Remove the screws (1) from the rolling bearing track.
- Remove the rolling bearing track (2).
- Remove the circlips (4), then the ball bearings (3).

3 - Installing the rolling bearing

- Put new rolling elements on the bearing track. Block in travel using the circlips.
- Lubricate the rolling bearings.

NB: *Only use lubricants recommended by the manufacturer.*

- Re-install the basket (see corresponding sheet).
- Put the machine back in the operational configuration.

Sheet C056	CORRECTIVE MAINTENANCE SHEET	Folio 1/1
	CHANGING THE HYDRAULIC FILTER	

 **Caution!**
 Ensure that the oil is not too hot.

 **Caution!**
 Use a container to collect oil to prevent pollution of the environment.

1 - Preliminary operations

- Put the machine in the maintenance configuration (see corresponding paragraph).
- Switch off electric power (see corresponding paragraph).
- Close the shut-off valve, if any. Otherwise, empty the hydraulic tank.

2 - Removing the hydraulic filter

- Disconnect the hydraulic filter hoses (1).

NB: Unscrew the hoses slowly to release residual hydraulic pressure.

- Fit caps to the hoses.
- Unscrew the fixing screws (2) and remove the hydraulic filter.
- Remove the two connectors (3) from the hydraulic filter.

3 - Installing the hydraulic filter

- Install the two connectors on a new hydraulic filter (see the table of tightening torque values).
- Put the equipped hydraulic filter back into place, respecting the oil flow direction and fix using the fixing screws.
- Reconnect the hydraulic hoses.
- Put the machine back into the operational configuration.
- Make several lifting cycles to purge the hydraulic circuit.



HA16/18PX - HA46/51JRT



H14/16TPX - HB40/44J

	CORRECTIVE MAINTENANCE SHEET	

Sheet C058	CORRECTIVE MAINTENANCE SHEET	Folio 1/1
	CHANGING THE U1 ELECTRONIC MODULE	

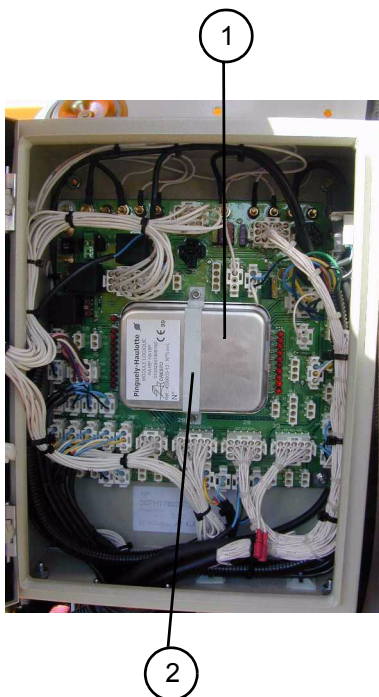

1 - Preliminary operations

- Put the machine in the maintenance configuration (see corresponding paragraph).
- Switch off electric power (see corresponding paragraph).
- Disconnect the « - » then « + » terminals of the starter battery to isolate the electric circuit.

2 - Removing the U1 electronic module

- Open the turntable electric box.
- Remove the fixing flange (2) from the U1 electronic module.
- Remove the U1 electronic module.

3 - Installing the U1 electronic module

- Install a new U1 electronic module, previously programmed by the manufacturer.
- Install the fixing flange.
- Close the electric box.
- Reconnect the « + » then « - » terminals of the starter battery.
- Put the machine back into the operational configuration.
- Check that the U1 electronic module works perfectly using the check list for the machine concerned.

4 - Testing the U1 electronic module

- Make all movements from the bottom control panel for two seconds.
- Make all movements from the top control panel for two seconds.
- Lift the jib (> 0°)
- Make a travel movement with the selector on high speed and check that movement speed is actually micro-speed.
- Lower the jib.
- Lift the arm to 3 metres.
- Make a travel movement with the selector on high speed and check that movement speed is actually micro-speed.
- Lower the arm.
- Lift the boom.
- Make a travel movement with the selector on high speed and check that movement speed is actually micro-speed.
- Lower the boom.



Caution!

Computers are not interchangeable, they have a serial number corresponding to a given machine. If this rule is ignored, dangerous malfunctions may occur.

Sheet C059	CORRECTIVE MAINTENANCE SHEET	Folio 1/1
	CHANGING A COIL	

1 - Preliminary operations

- Put the machine in the maintenance configuration (see corresponding paragraph).
- Switch off electric power (see corresponding paragraph).

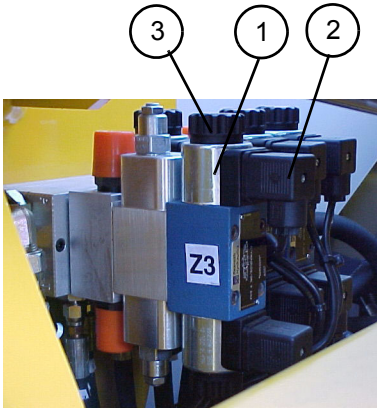

2 - Removing a coil

- Disconnect the electric connector (2) from the coil concerned.
- Unscrew the nut (3) and remove the coil (1).

3 - Installing a coil

- Put a new coil into place (1) and fix with the nut (3).
- Reconnect the electric connector (2) to the coil.
- Put the machine back into the operational configuration.
- Check proper operation by making the movement corresponding to the replaced coil.

Sheet C062	CORRECTIVE MAINTENANCE SHEET	Folio 1/1
	CHANGING A RELAY	

1 - Preliminary operations

- Put the machine in the maintenance configuration (see corresponding paragraph).
- Switch off electric power (see corresponding paragraph).
- Disconnect the « - » then « + » terminals of the starter battery.

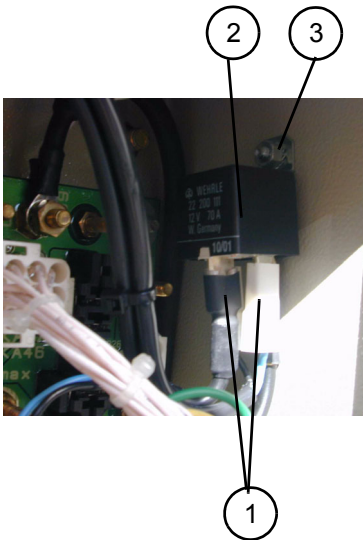

2 - Removing a relay

- Open the turntable electric box.
- Mark and disconnect the electric connections (1) of the relay (2).
- Remove the relay by removing the fixing bolt (3).

3 - Installing a relay

- Put a new relay into place and fix using its bolt equipped with a new grower washer.
- Reconnect the electric connections according to the marks made during dismantling.
- Close the turntable box.
- Reconnect the « + » then « - » terminals of the starter battery.
- Put the machine back into the operational configuration.

Pinguely-Haulotte

Sheet C063	CORRECTIVE MAINTENANCE SHEET	Folio 1/1
	CHANGING THE PRINTED CIRCUIT	

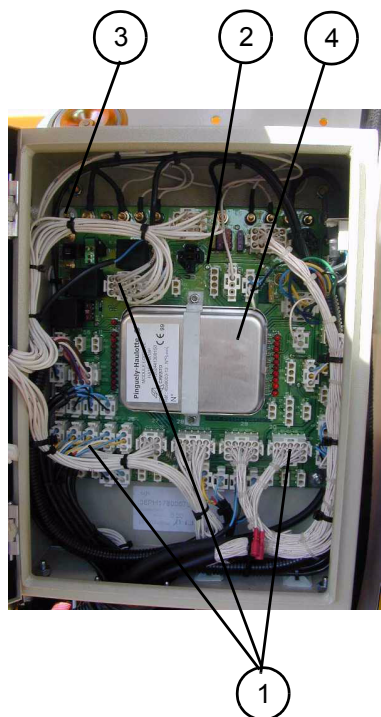

1 - Preliminary operations

- Put the machine in the maintenance configuration (see corresponding paragraph).
- Switch off electric power (see corresponding paragraph).
- Disconnect the « - » then « + » terminals of the starter battery.

2 - Removing the printed circuit

- Open the turntable electric box.
- Carefully mark and disconnect all the electric connections (1) of the printed circuit (2).
- Remove the U1 electronic module (4) (see corresponding sheet)
- Remove the bolts (3) fixing the board to the box and their sealing washers.
- Remove the printed circuit and silent-blocks equipping the fixing bolts.

3 - Installing the printed circuit

- Put a new printed circuit into place and fix using the bolts equipped with silent blocks, sealing rings and new toothed washers.
- Install the U1 electronic module (see corresponding sheet).
- Reconnect the electric connections according to the marks made during dismantling.
- Close the turntable box.
- Reconnect the « + » then « - » terminals of the starter battery.
- Put the machine back into the operational configuration.
- Test the printed circuit.

4 - Testing the printed circuit

- Perform the computer operating test (see «changing the U1 electronic module» sheet).

Sheet C064	CORRECTIVE MAINTENANCE SHEET	Folio 1/1
	CHANGING THE FAIL-SAFE PEDAL	

1 - Preliminary operations

- Put the machine in the maintenance configuration (see corresponding paragraph).
- Switch off electric power (see corresponding paragraph).
- Disconnect the « - » then « + » terminals of the starter battery.



2 - Removing the fail-safe pedal

- Open the platform electric box.
- Mark and disconnect the electric connections (1) of the fail-safe pedal (2) in the box.
- Mark the pedal cabling path (1) along the vertical platform parts and then cut the fixing collars (3).
- Remove the pedal by removing the pedal's fixing bolts (4) and their washers.

3 - Installing the fail-safe pedal

- Put a new pedal into place and fix using the bolts and their washers.
- Reconnect the electric connections in the box, according to the marks made during dismantling.
- Close the platform box.
- Fix the electric cable to the vertical platform parts using collars.
- Reconnect the « + » then « - » terminals of the starter battery.
- Put the machine back into the operational configuration.
- Check that movements from the platform are possible only if the fail-safe pedal is pressed.

Sheet C067	CORRECTIVE MAINTENANCE SHEET	Folio 1/1
	CHANGING AN ELECTROVALVE	

 **Caution!**
Ensure that the oil is not too hot.

 **Caution!**
Use a container to collect oil to prevent pollution of the environment.

1 - Preliminary operations

- Put the machine in the maintenance configuration (see corresponding paragraph).
- Switch off electric power (see corresponding paragraph).

2 - Removing an electrovalve

- Mark and disconnect the electric connections(1) of the coils.
- Mark the installation position of the electrovalve on the block.
- Unscrew the four fixing screws (3) of the electrovalve (2) and remove.

3 - Installing an electrovalve

- Put a new electrovalve equipped with its seals into place and fix using the 4 screws, in the position of the electrovalve on the block. Tighten to the recommended torque (see corresponding paragraph).
- Reconnect the electrovalve's electric connections, according to the marks made during dismantling.
- Put the machine back into the operational configuration.
- Make several movement cycles using the replaced electrovalve to purge the hydraulic circuit.
- Check the level of the hydraulic oil tank.

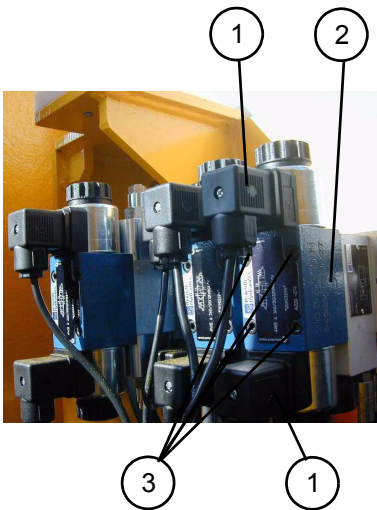

Sheet C068	CORRECTIVE MAINTENANCE SHEET	Folio 1/1
	CHANGING THE DOUBLE BALANCING VALVE OF THE ROTATION FUNCTION	

 **Caution!**
Ensure that the oil is not too hot.

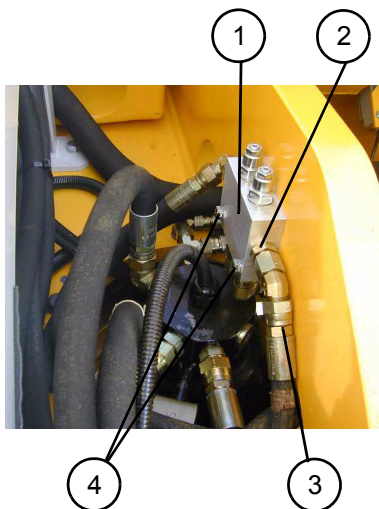

 **Caution!**
Balancing valves are safety elements. They are calibrated in the plant and must not be re-adjusted.

1 - Preliminary operations

- Put the machine in the maintenance configuration (see corresponding paragraph).
- Switch off electric power (see corresponding paragraph).

2 - Removing a double balancing valve

- Mark and disconnect the four hydraulic hoses (3) on the double balancing valve unit (1).

NB: *Unscrew the hoses slowly to release residual hydraulic pressure.*

- Fit the hoses with caps.
- Remove the unit's 4 unions (2).
- Remove the unit (1) by unscrewing the 2 fixing bolts (4).

3 - Installing a double balancing valve

- Put a new unit into place and fix with the two bolts, equipped with new toothed washers.
- Put the four unions equipped with new O-rings back onto the unit. Tighten to the recommended torque (see corresponding paragraph).
- Reconnect the hydraulic hoses, according to the marks made during dismantling. Tighten to the recommended torque (see corresponding paragraph).
- Put the machine back into the operational configuration.
- Make several movement cycles using the replaced double balancing valve to purge the hydraulic circuit.
- Check the level of the hydraulic oil tank.

Sheet C069	CORRECTIVE MAINTENANCE SHEET	Folio 1/2
	DISMANTLING / RE-ASSEMBLING THE JIB	

 **Caution!**
Ensure that the oil is not too hot.

 **Caution!**
Make sure that the lifting equipment is in good condition and of sufficient capacity.

 **Caution!**
Use a container to collect oil to prevent pollution of the environment.

 **Caution!**
It is essential to put the component in slings before dismantling/re-assembling it.

1 - Preliminary operations

- Put the machine in the maintenance configuration (see corresponding paragraph).
- Switch off electric power (see corresponding paragraph).
- Remove contactor SQ2 (see corresponding sheet).

2 - Removing the platform+support assembly

- Mark and disconnect the electric connections at the platform box.
- Mark and disconnect the hydraulic hoses of the platform rotation motor and the jib cylinder (1).

NB: *Unscrew the hoses slowly to release residual hydraulic pressure.*

- Fit caps to the hoses.
- Open the two cable passage collars on the platform, and the three collars along the jib.
- Mark the path of the electric cables and hoses, then remove all cables passing along the length of the jib.
- Put the platform into slings.
- Put the jib cylinder (1) and vertical elements (2) and (3) into slings.
- Remove the four bolts and pin stop rings (5) fixing the platform assembly (4).
- Remove the two Mécanindus pins blocking the pins (5).
- Remove the two pins (5) and remove the platform assembly.

3 - Removing the jib

- Mark the position of the cam (6) of sensor SQ2 (7).
- Remove the two pins (8) fixing the jib to the jib link part, as described above, then remove the vertical parts of the jib (2) and (3) and the cylinder (1).

4 - Removing the jib link part (9)

- Put the jib link part into slings (9).
- Put the receiver compensation cylinder into slings (10).
- Remove the Mécanindus pin blocking the pin, then remove the pin (11) of the receiver compensation cylinder (10).
- Remove the male clevis blocking the link part rotation pin (12) by removing its fixing screw.
- Remove the rotation pin (12) then remove the jib link part (9).

5 - Installing the jib link part

NB: *Lubricate all bores before re-installing the pins.
 Only use lubricants recommended by the manufacturer.*

- Check the condition of the rings of the different jib pins, and replace if necessary.
- Put the jib link part back into place.
- Install the link part rotation pin.
- Install the clevis and block using the screw, previously coated with normal blue loctite 243.
- Install the receiver compensation cylinder pin and block with a new Mécanindus pin.

Sheet C069	CORRECTIVE MAINTENANCE SHEET	Folio 2/2
	DISMANTLING / RE-ASSEMBLING THE JIB	

6 - Installing the jib

- Put the jib and its cylinder into place and install the articulation pins.
- Fix the pins with Mécanindus pins.
- Install the 3 stop rings and the contactor SQ2 cam in the positions marked during dismantling and fix with their bolts.

7 - Installing the platform+support assembly

- Put the platform+support assembly into place and install the two articulation pins.
- Block the pins with new Mécanindus pins.
- Install the four pin stop rings and fix using their fixing bolts.
- Pass the hydraulic hoses and electric cables along the jib according to the marks made during dismantling and reconnect.
- Install the two cable passage collars on the platform and the three collars along the length of the jib.
- Install and set the contactor SQ2 (see corresponding sheet).
- Put the machine back into the operational configuration.
- Make several jib lifting, boom lifting and platform rotation movements, to purge the hydraulic circuit.
- Check the level of the hydraulic oil tank.

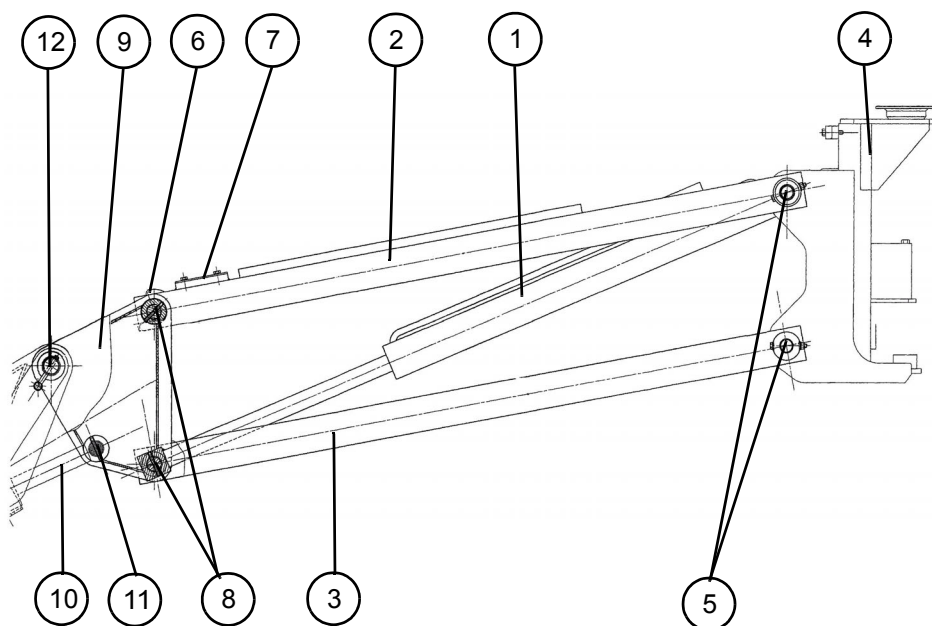

Sheet C079	CORRECTIVE MAINTENANCE SHEET	Folio 1/1
	CHANGING A FLOW SEPARATOR	



Caution!

Ensure that the oil is not too hot.



Caution!

Use a container to collect oil to prevent pollution of the environment.

1 - Preliminary operations

- Put the machine in the maintenance configuration (see corresponding paragraph).
- Switch off electric power (see corresponding paragraph).

2 - Removing a flow separator

- Remove the flow separator (1) by unscrewing it.

3 - Installing a flow separator

- Screw a new flow separator, whose characteristics correspond to the machine in question, into the hydraulic block.
- Tighten to the recommended torque:
 - Flow separator ref. FDC1-10: 47 to 54 Nm. (34 to 39.8 lb.ft)
 - Flow separator ref. FDC1-16: 108 to 122 Nm (79.6 to 89.9 lb.ft).
- Put the machine back into the operational configuration.
- Make several movements using the replaced flow separator to purge the circuit.
- Check that the corresponding movement is made correctly.

1



Sheet C082	CORRECTIVE MAINTENANCE SHEET	Folio 1/1
	CHANGING A BALANCING VALVE FOR THE COMPENSATION FUNCTION	



Caution!
Ensure that the oil is not too hot.



Caution!
Use a container to collect oil to prevent pollution of the environment.



Caution!
Balancing valves are safety elements. They are calibrated in the plant and must not be re-adjusted.

1 - Preliminary operations

- Put the machine in the maintenance configuration (see corresponding paragraph).
- Switch off electric power (see corresponding paragraph).

2 - Removing a balancing valve

- Remove the balancing valve (1) by unscrewing it.

3 - Installing a balancing valve

- Screw a new balancing valve, whose characteristics correspond to the machine in question, into the hydraulic block. Tighten to a torque of 45 to 50 Nm (33 to 36.7 lb.ft).
- Put the machine back into the operational configuration.
- Make several movements using the replaced balancing valve to purge the circuit.
- Check that the corresponding movement is made correctly.

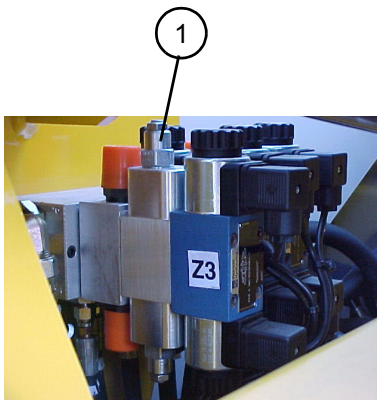

Sheet C083	CORRECTIVE MAINTENANCE SHEET	Folio 1/1
	CHANGING A DOUBLE FLOW LIMITER FOR THE COMPENSATION FUNCTION	

 **Caution!**
Ensure that the oil is not too hot.

 **Caution!**
Use a container to collect oil to prevent pollution of the environment.

1 - Preliminary operations

- Put the machine in the maintenance configuration (see corresponding paragraph).
- Switch off electric power (see corresponding paragraph).

2 - Removing a double flow limiter (1)

- Mark the installation position of the electro distributor, balancing valve and double flow limiter.
- Remove the 4 fixing screws (2), then take out the electrovalve (3) + balancing valve (4) + double flow limiter (1) assembly.
- Remove the double flow limiter (1).

3 - Installing the double flow limiter

- Replace the seals and put into place on the hydraulic block a new flow limiter (1), whose characteristics correspond to the machine in question, then the balancing valve (4) and the electrovalve (3).
- Fix the assembly with the 4 fixing screws (2). Tighten to the recommended torque (see corresponding chapter).
- Put the machine back into the operational configuration.
- Make several movements using the replaced double flow limiter to purge the circuit.
- Adjust compensation up and down speeds (see corresponding chapter).
- Check that the corresponding movement is made correctly.

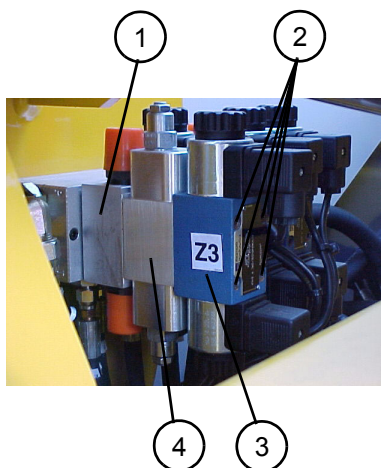

Sheet C084	CORRECTIVE MAINTENANCE SHEET	Folio 1/1
	CHANGING A NON-RETURN VALVE ON THE STEERING HYDRAULIC BLOCK	



Caution!
Ensure that the oil is not too hot.



Caution!
Use a container to collect oil to prevent pollution of the environment.

1 - Preliminary operations

- Put the machine in the maintenance configuration (see corresponding paragraph).
- Switch off electric power (see corresponding paragraph).

2 - Removing a non-return valve

- Remove the non-return valve (1) by unscrewing it.

3 - Installing a non-return valve

- Screw a new non-return valve, whose characteristics correspond to the machine in question, into the hydraulic block.
- Put the machine back into the operational configuration.
- Make several movements using the replaced non-return valve to purge the circuit.
- Check that the corresponding movement is made correctly.

1

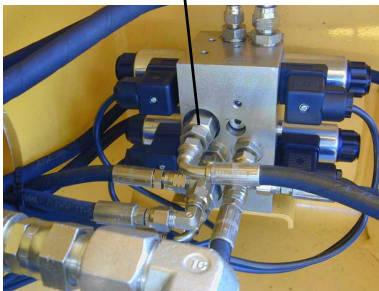

Sheet C085	CORRECTIVE MAINTENANCE SHEET	Folio 1/2
	CHANGING A STEERING PIVOT ON A NON-DRIVE WHEEL	



Caution!

Ensure that the oil is not too hot.



Caution!

Use a container to collect oil to prevent pollution of the environment.



Caution!

It is essential to put the component in slings before dismantling/re-assembling it.

1 - Preliminary operations

- Put the machine in the maintenance configuration (see corresponding paragraph).
- Switch off electric power (see corresponding paragraph).
- Remove the wheel corresponding to the element to be removed (see corresponding sheet).

2 - Removing the bearings (if necessary)

- Remove the cap (10).
- Remove the counter-nut (11), brake washer (12) and nut (13).
- Remove the hub (14) of the pivot (1).
- Remove the bearings (16).
- Remove the seal (15).

3 - Removing a pivot (see figure 1)

- Place a wedge under the steering pivot (1).
- Remove the fixing screw (2) from the steering clevis pin.
- Remove the steering clevis pin (3).
- Remove the two screws (4) from the two caps on the pivot pin and remove the two caps (5).
- Take the Mécanindus pin from each pivot pin (6), and remove the pivot pin and support washer (7).
- Remove the steering pivot (1).

4 - Installing a pivot

- Put the steering pivot into place.
- Replace pins, lubricators and support washers if necessary.
- Put back the support washers and pivot pins, and block using new Mécanindus pins.
- Put back the pivot pin caps and fix using fixing screws and washers.
- Adjust wheel alignment if necessary:
 - slacken the counter-nut (8),
 - screw or unscrew the clevis (9) to adjust the length of the steering bar.
 - tighten the counter-nut (8).
- Put back the steering clevis pin and fix using the screw equipped with a new grower washer.

NB: *When re-installing the pins, take the measures necessary to avoid damaging the pins, rings and bores.*

5 - Installing the bearings (if applicable)

- Lubricate the bearings and pivot pin.

NB: *Only use lubricants recommended by the manufacturer.*

- Install a new seal (15).
- Install the bearings (16) on the hub (14).
- Install the hub (14) on the pivot (1).
- Install the nut (13).
- Block the nut (13) until the wheel turns with difficulty and turn back one quarter turn.
- Install the brake washer (12) and counter-nut (11).
- Block the counter-nut (11), then raise the wings of the brake washer.
- Put back the cap (10).

6 - Additional operations

- Put back the wheel (see corresponding sheet).
- Put the machine back in the operational configuration.
- Make several travel movements to check correct operation.
- Lubricate the pins with the lubricators.

Sheet C085	CORRECTIVE MAINTENANCE SHEET	Folio 2/2
	CHANGING A STEERING PIVOT ON A NON-DRIVE WHEEL	

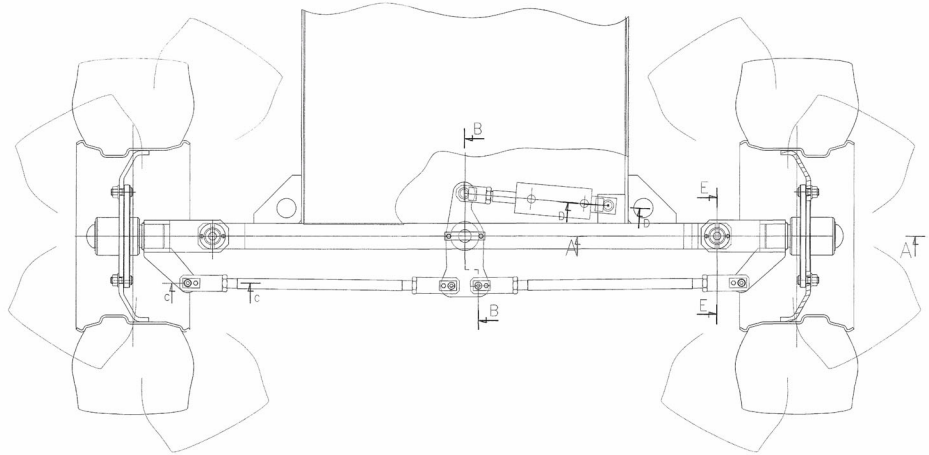

A - A

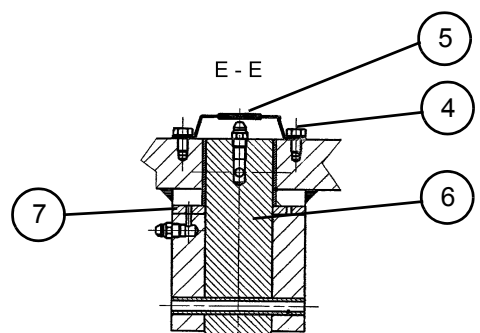
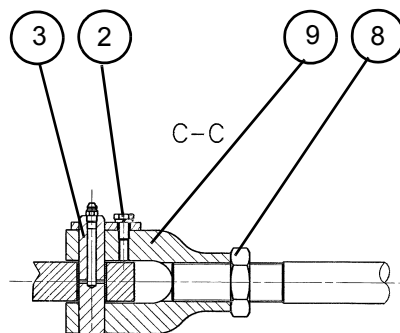
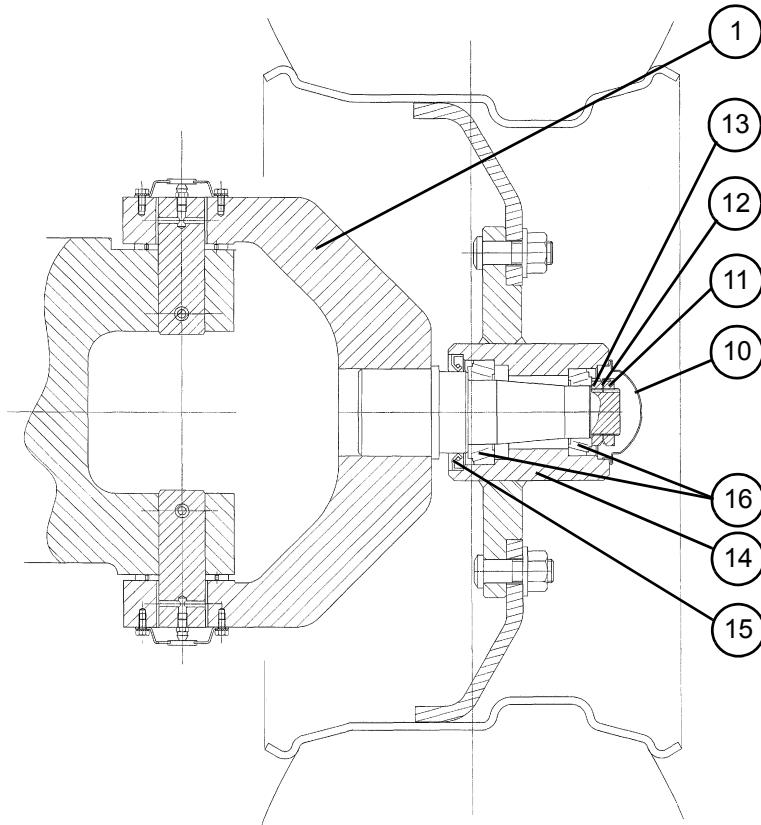

Sheet C086	CORRECTIVE MAINTENANCE SHEET	Folio 1/2
	DISMANTLING AND RE-ASSEMBLING THE STEERING SYSTEM	

 **Caution!**
Ensure that the oil is not too hot.

 **Caution!**
Use a container to collect oil to prevent pollution of the environment.

 **Caution!**
It is essential to put the component in slings before dismantling/re-assembling it.

1 - Preliminary operations

- Put the machine in the maintenance configuration (see corresponding paragraph).
- Switch off electric power (see corresponding paragraph).

2 - Removing a steering bar

- Remove the fixing screw (1) from the two steering clevis pins (2).
- Remove the two steering clevis pins (2).
- Unscrew the counter-nut (11).
- Remove the steering bar (3).

NB: Repeat the operation (2) for the other side.

3 - Removing the steering lever (section B-B)

- Remove the Nylstop nut (4) and the washer (5) from the cylinder fastening pin.
- Remove the cylinder fastening pin (6).
- Remove the male clevis (12).
- Remove the screws and washers (13/14) then the central steering pin (8).
- Remove the steering lever (9).

4 - Installing the steering lever

NB: When re-installing the pins, take the measures necessary to avoid damanging the pins, rings and bores.

- Replace the pins and lubricators if necessary.
- Put the steering lever into place.
- Put back the central steering pin, then the screws and new washers (13/14)
- Put back the male clevis and fix with its fixing screw equipped with a new washer.
- Put back the cylinder fastening pin and fix with a new Nylstop nut and its washer.

5 - Installing a steering bar

- Replace the pins and lubricators if necessary.
- Put the steering bar into place, performing the removal operations in reverse order.
- Adjust wheel alignment if necessary:
 - slacken the counter-nut (10) on the steering bar,
 - screw or unscrew the clevis (11) to adjust the length of the steering bar.
 - tighten the counter-nut (10).
- Put back the two steering clevis pins.
- Put back the fixing screws of the two steering clevis pins.

6 - Additional operations

- Put the machine back in the operational configuration.
- Lubricate the pins with lubricators.

Sheet C086	CORRECTIVE MAINTENANCE SHEET	Folio 2/2
	DISMANTLING AND RE-ASSEMBLING THE STEERING SYSTEM	

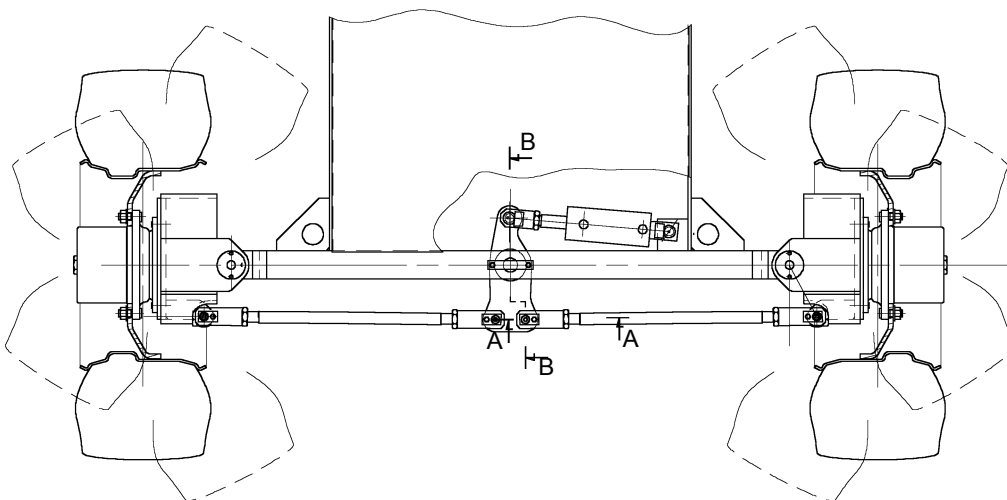
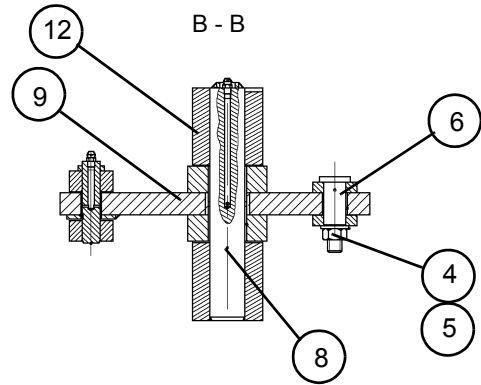
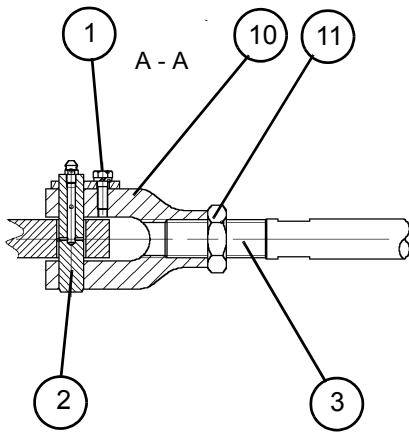
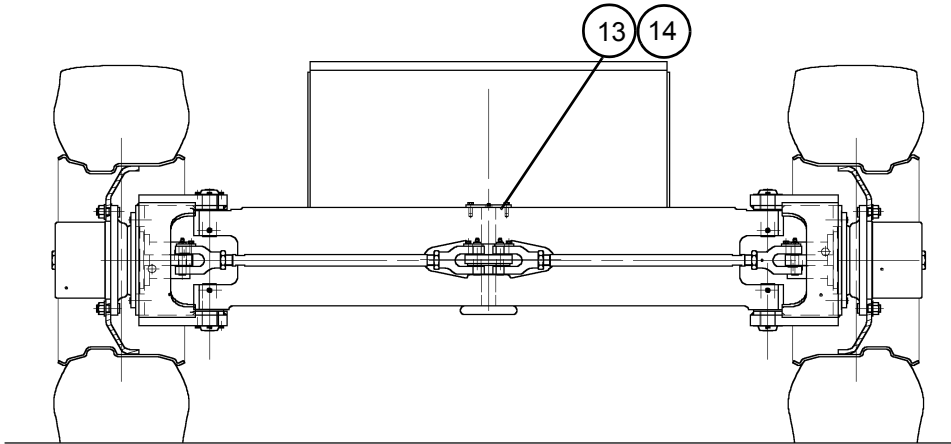

Sheet C087	CORRECTIVE MAINTENANCE SHEET	Folio 1/1
	CHANGING THE STEERING CYLINDER	



Caution!

Ensure that the oil is not too hot.



Caution!

Use a container to collect oil to prevent pollution of the environment.



Caution!

It is essential to put the component in slings before dismantling/re-assembling it..

8 - Preliminary operations

- Put the machine in the maintenance configuration (see corresponding paragraph).
- Switch off electric power (see corresponding paragraph).

9 - Removing the steering cylinder

- Open the upper cover of the chassis.
- Mark and disconnect the two hoses (2) of the steering cylinder (1).

NB: *Unscrew the hoses slowly to release residual hydraulic pressure.*

- Put caps on the hoses.
- Put the cylinder in slings.
- Remove the Nylstop nuts (4) then remove the two fastening pins (3) from the steering cylinder.
- Remove the steering cylinder.

10 - Installing the steering cylinder

- Put a new steering cylinder into place.
- Put back the fastening pins and fix using new Nylstop nuts and washers.
- Reconnect the hydraulic hoses, according to the marks made during dismantling.
- Check that there is sufficient oil in the hydraulic tank.
- Put the machine back into the operational configuration.
- Make several steering movements to purge the hydraulic circuit.
- Check the level of the hydraulic oil tank.

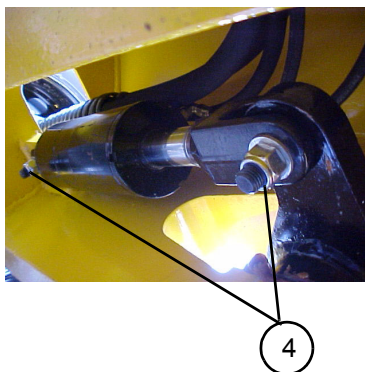
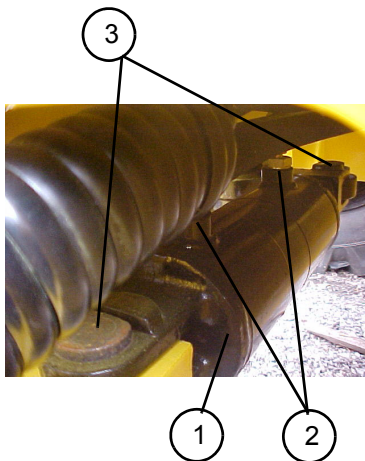

Pinguely-Haulotte

Sheet C091	CORRECTIVE MAINTENANCE SHEET	Folio 1/2
	CHANGING THE HYDRAULIC PUMP	



Caution!

Ensure that the oil is not too hot.



Caution!

Close the shut-off valve if any, otherwise, empty the hydraulic oil tank.



Caution!

Use a container to collect oil to prevent pollution of the environment.



Caution!

It is essential to put the component in slings before dismantling/re-assembling it.

11 - Preliminary operations

- Put the machine in the maintenance configuration (see corresponding paragraph).
- Switch off electric power (see corresponding paragraph).
- Close the shut-off valve if any, otherwise, empty the hydraulic oil tank.

12 - Removing the hydraulic pump

- Mark and disconnect the pump hoses (1).

NB: Unscrew the hoses slowly to release residual hydraulic pressure.

- Put caps on the hoses.
- Remove the hydraulic unions (4) screwed on the pump.
- Remove the screws and washers (2) fixing the pump to the motor flange (3), then remove the pump (5).
- Remove the split spined hub (6) by unscrewing its tightening screw (7).
- Discard the O-rings.

13 - Installing the hydraulic pump

- Equip the unions with new O-rings.
- Screw the hydraulic unions on the pump.
- Check that the circlips and spacer are in good condition and in position inside the split spined hub.
- Lubricate then fit the split spined hub onto a new pump, until the pump shaft comes up against the spacer. Tighten to a torque of 83 N.m (61.21 lb.ft).
- Coat the hub's tightening screws with normal blue loctite 243
- Install the pump on the flange and fix using fixing screws previously coated with normal blue loctite 243 and equipped with new grower washers. Tighten to a torque of 86 N.m (63.43 lb.ft).
- Reconnect the hydraulic hoses according to the marks made during dismantling.
- Open the shut-off valve, if any.
- Check the level of the hydraulic tank and fill if necessary.
- Before starting, fill the pump pan with hydraulic oil (hole L engraved on the pump).

14 - Additional operations

- Put the machine back in the operational configuration.
- Make several extension movements to purge the hydraulic circuit.
- Check the level of the hydraulic oil tank.
- Adjust pump flow, the load sensing pressure limiter and the main pressure limiter (see corresponding sheet).

Sheet C091	CORRECTIVE MAINTENANCE SHEET	Folio 2/2
	CHANGING THE HYDRAULIC PUMP	

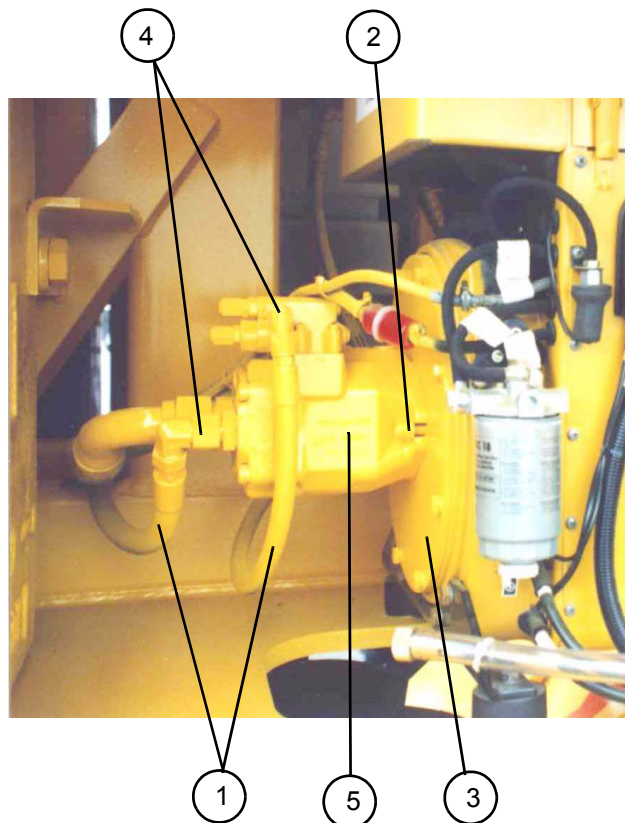
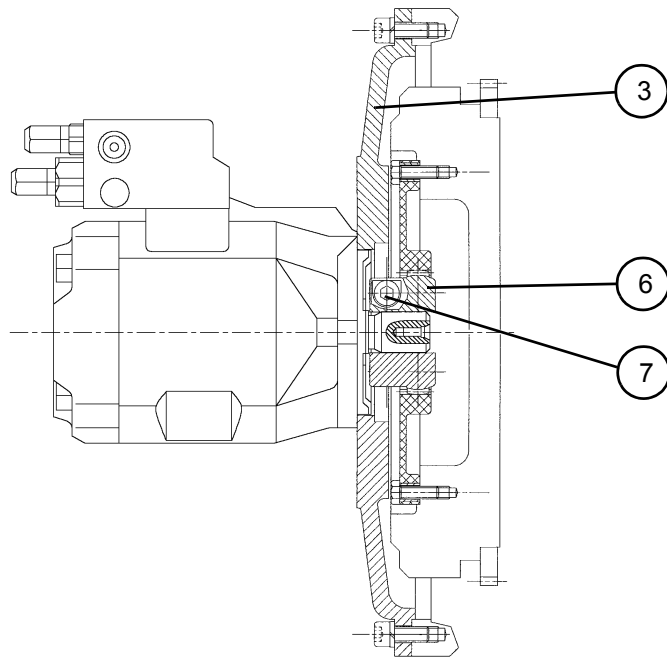

Sheet C092	CORRECTIVE MAINTENANCE SHEET	Folio 1/1
	CHANGING THE HYDRAULIC BLOCK (TRAVEL / ON-OFF MOVEMENT / STEERING)	

 **Caution!**
Ensure that the oil is not too hot.

 **Caution!**
Use a container to collect oil to prevent pollution of the environment.

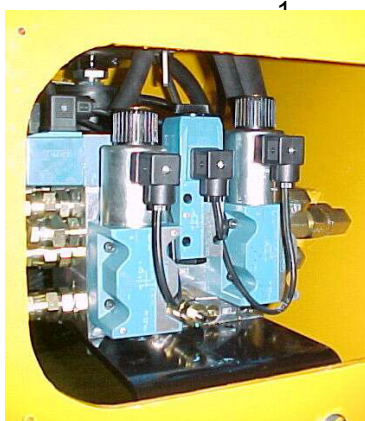
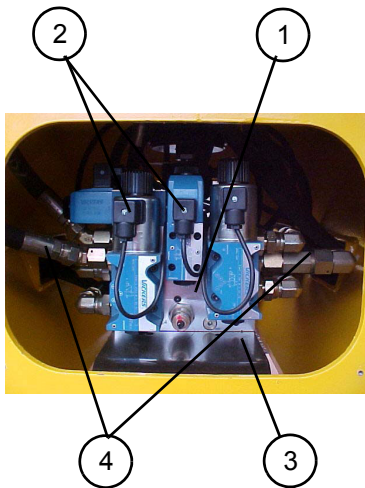

Travel

1 - Preliminary operations

- Put the machine in the maintenance configuration (see corresponding paragraph).
- Switch off electric power (see corresponding paragraph).

2 - Removing the hydraulic block

- Remove the chassis inspection flap enabling access to the hydraulic block.
- Mark and disconnect the electric connections (2) of the hydraulic block (1).
- Mark and disconnect the block's hoses (4).

NB: *Unscrew the hoses slowly to release residual hydraulic pressure.*

- Put caps on the hoses.
- Place a wedge under the hydraulic block if necessary.
- Remove the hydraulic block by removing the fixing screws and washers (3).

3 - Installing the hydraulic block

- Put the hydraulic block into place and fix using screws equipped with new toothed washers.
- Reconnect the hydraulic hoses according to the marks made during dismantling.
- Reconnect the electric connections of the hydraulic block, according to the marks made during dismantling.
- Put the machine back in the operational configuration.
- Make several movements using the replaced hydraulic block to purge the hydraulic circuit.
- Check the level of the hydraulic oil tank.



On/off movement

Pinguely-Haulotte

Sheet C093	CORRECTIVE MAINTENANCE SHEET	Folio 1/2
	CHANGING THE DISTRIBUTION HYDRAULIC BLOCK	

 **Caution!**
Ensure that the oil is not too hot.

 **Caution!**
Use a container to collect oil to prevent pollution of the environment.

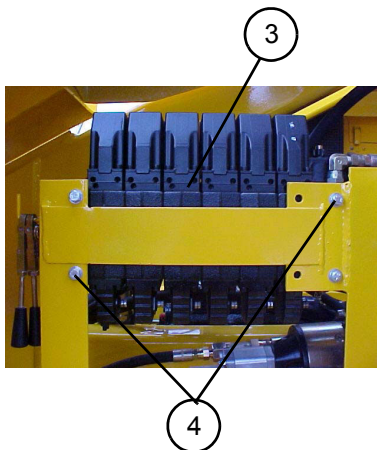

1 - Preliminary operations

- Put the machine in the maintenance configuration (see corresponding paragraph).
- Switch off electric power (see corresponding paragraph).

2 - Removing the distribution hydraulic block

- Mark and disconnect the electric connections (1) of the hydraulic block (3).
- Mark and disconnect the block's hoses (2).

NB: *Unscrew the hoses slowly to release residual hydraulic pressure.*

- Put caps on the hoses.
- Put the hydraulic block in slings.
- Remove the fixing screws and washers (4) from the hydraulic block.
- Take out the block from the top of the turntable.
- Dismantle the hydraulic block to change one of its elements, if necessary (see corresponding sheet).

3 - Installing the distribution hydraulic block

- If the distribution block installed is new, fit the new block with the unions retained from the old one but replace the O-rings. Tighten to the recommended torque (see concerned chapter).
- Put the hydraulic block into place and fix with screws, equipped with new grower washers.
- Reconnect the hydraulic hoses according to the marks made during dismantling. Tighten to the recommended torque (see chapter concerned).
- Reconnect the hydraulic block's electric connections, according to the marks made during dismantling.
- Put the machine back in the operational configuration.
- Check that there is sufficient oil in the hydraulic tank.
- Make several lifting, travel, steering and turntable rotation movements to purge the hydraulic circuit and test block operation.
- Check the level of the hydraulic oil tank.

Pinguely-Haulotte

Sheet C094	CORRECTIVE MAINTENANCE SHEET	Folio 1/1
	INTRINSIC DISMANTLING / RE-ASSEMBLY OF THE DISTRIBUTION HYDRAULIC BLOCK	



Caution!

Ensure that the oil is not too hot.



Caution!

Use a container to collect oil to prevent pollution of the environment.

1 - Preliminary operations

- Remove the distribution hydraulic block (see corresponding sheet).

2 - Dismantling the distribution hydraulic block (1)

- Mark the assembly position of the input plate, input module, distribution elements and closing plate.
- If necessary, remove the control units (see corresponding sheet).
- Remove the fixing nuts and 3 tie rods (2) then separate the elements.

3 - Re-assembling the distribution hydraulic block

- Replace the O-ring seals.
- If necessary, put back the control units (see corresponding sheet).
- Remount the input plate, input module, distribution elements and closing plate.
- Put back the fixing nuts and 3 tie rods (2). Tighten to 2.2 daN.m (15.91 lb.ft).
- Put back the distribution hydraulic block (see corresponding sheet).
- Check that there is sufficient oil in the hydraulic tank.
- Put the machine back in the operational configuration.
- Make several lifting, travel, steering and turntable rotation movements to purge the hydraulic circuit.
- Check the level of the hydraulic oil tank.

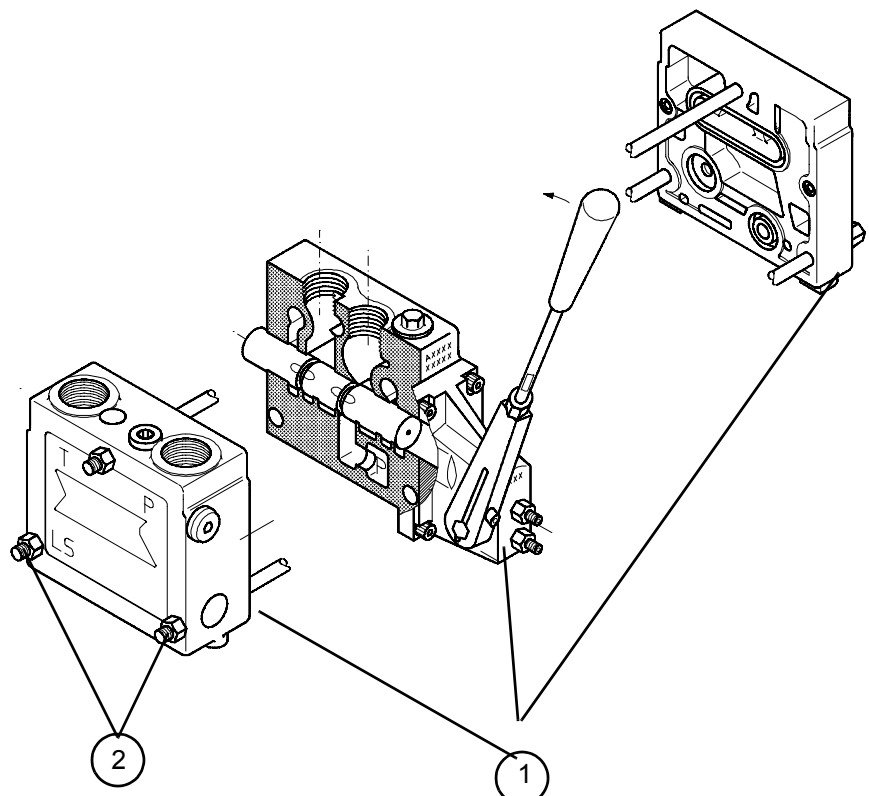

Sheet C097	CORRECTIVE MAINTENANCE SHEET	Folio 1/1
	CHANGING A TURNTABLE COVER	

 **Caution!**
Do not use the machine during maintenance operations.

1 - Preliminary operations

- Put the machine in the maintenance configuration (see corresponding paragraph).
- Switch off electric power (see corresponding paragraph).

2 - Removing a cover

- Open the relevant cover (1).
- Put the cover in slings.
- Remove the nuts and washers (3) fixing the gas springs to the connecting rods (2) supporting the cover.
- Remove the bolts (5) and (6) fixing the cover (1) to the two hinges (4).
- Retain the cover support connecting rods (2).
- Remove the cover.

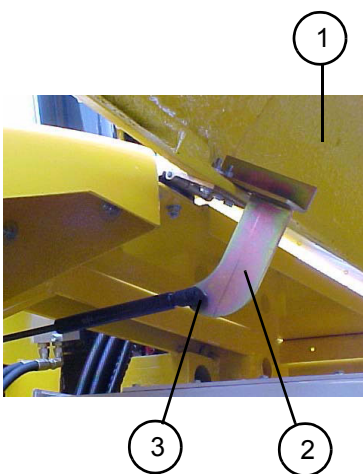

3 - Installing a cover

- Position a new cover, and fix to the hinges (4) with screws (5).
- Put back the cover support connecting rods using their fixing screws (6).
- Fix the gas springs to the cover connecting rods (2) using nuts and washers (3).
- Check that the cover opens and closes properly.
- If necessary, adjust the cover using screws (4) and (5).
- Put the machine back in the operational configuration.

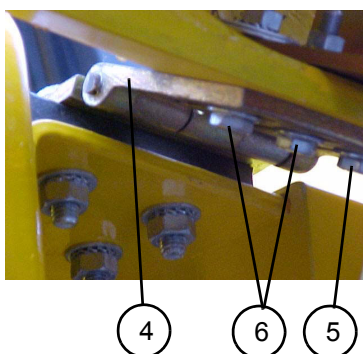

Sheet C099	CORRECTIVE MAINTENANCE SHEET	Folio 1/1
	CHANGING THE TURNTABLE ROTATION HYDRAULIC MOTOR	



Caution!
Put the turntable rotation blocking pin into place.



Caution!
It is essential to put the component in slings before dismantling/re-assembling it.



Caution!
Ensure that the oil is not too hot.



Caution!
Use a container to collect oil to prevent pollution of the environment.

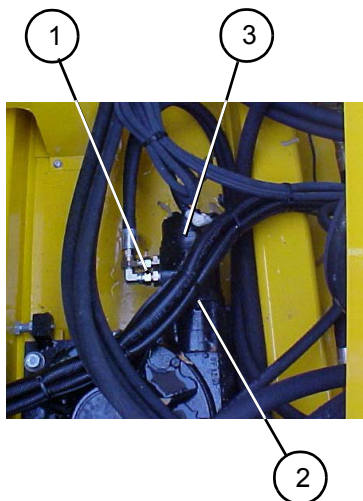

1 - Preliminary operations

- Lift the boom sufficiently to enable access to the turntable rotation hydraulic motor.
- Place wedges under the boom to bear its weight.
- Put the machine in the maintenance configuration (see corresponding paragraph).
- Switch off electric power (see corresponding paragraph).
- If necessary, close the shut-off valve or empty the hydraulic tank.

2 - Removing the hydraulic motor

- Mark and disconnect the two hoses (1) of the hydraulic motor (3).

NB: Unscrew the hoses slowly to release residual hydraulic pressure.

- Put caps on the hoses.
- Place a wedge under the hydraulic motor.
- Remove its two fixing screws (2)
- Remove the hydraulic motor.
- Remove the blocking screws from the keyed sleeve at the end of the motor shaft.
- Remove and retain the keyed sleeve.

3 - Installing the hydraulic motor

- Put the keyed sleeve back at the end of the motor shaft (coat the blocking screw with blue loctite).
- Put a new hydraulic motor into place.
- Fix the hydraulic motor with the two fixing screws equipped with new spring washers.
- Reconnect the hydraulic hoses according to the marks made during dismantling.

4 - Additional operations

- Remove the boom wedge.
- Put the machine back in the operational configuration.
- Make several turntable rotation movements to purge the hydraulic circuit.
- Check the level of the hydraulic oil tank.

Pinguely-Haulotte

Sheet C100	CORRECTIVE MAINTENANCE SHEET	Folio 1/2
	CHANGING THE SWING JOINT ASSEMBLY	

 **Caution!**
Put the turntable rotation blocking pin into place.

 **Caution!**
It is essential to put the component in slings before dismantling/re-assembling it.

 **Caution!**
Ensure that the oil is not too hot.

 **Caution!**
Use a container to collect oil to prevent pollution of the environment.

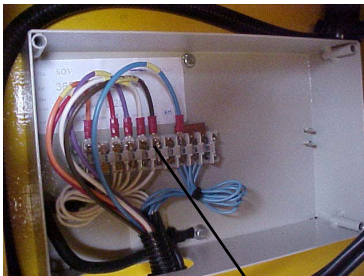

5

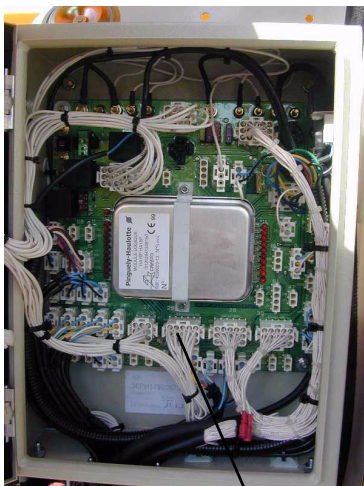

6

1 - Preliminary operations

- Lift the boom sufficiently to enable access to the swing joint.
- Place wedges under the boom to bear its weight.
- Put the machine in the maintenance configuration (see corresponding paragraph).
- Switch off electric power (see corresponding paragraph).
- If necessary, close the shut-off valve or empty the hydraulic tank.

2 - Removing the swing joint

- Open the chassis box, mark and disconnect all electric connectors (5).
- Open the turntable box, mark and disconnect all electric connectors (6) from the swing joint wiring harness.
- Free the two electric wiring harnesses (2) of the swing joint after marking their respective paths.
- Mark and disconnect the hydraulic caps and hoses (1) of the swing joint (3), on the turntable and below the chassis.

NB: *Unscrew hoses slowly to release residual hydraulic pressure.*

- Put caps on the hoses.
- Put the swing joint in slings.
- Remove the swing joint's stop screw (4).
- Remove the screws (7) fixing the swing joint to the chassis.
- Remove the swing joint from underneath the chassis.

3 - Installing the swing joint assembly

- Put the swing joint into place from underneath the chassis, and fix with fixing screws equipped with new nylstop nuts.
- Put back the swing joint rotation stop screw (4).
- Reconnect the hydraulic hoses and caps on the swing joint according to the marks made during dismantling.
- Pass the wiring harnesses in the machine along their original paths.
- Reconnect the electric connections in the chassis box and turntable box according to the marks made during dismantling.

4 - Additional operations

- Put the machine back in the operational configuration.
- Remove the wedges from under the boom.
- Make several steering and travel movements using all possible travel speeds to purge the hydraulic circuit.
- Check that the electric controls work properly.
- Check the level of the hydraulic oil tank.

Sheet C100	CORRECTIVE MAINTENANCE SHEET	Folio 2/2
	CHANGING THE SWING JOINT ASSEMBLY	

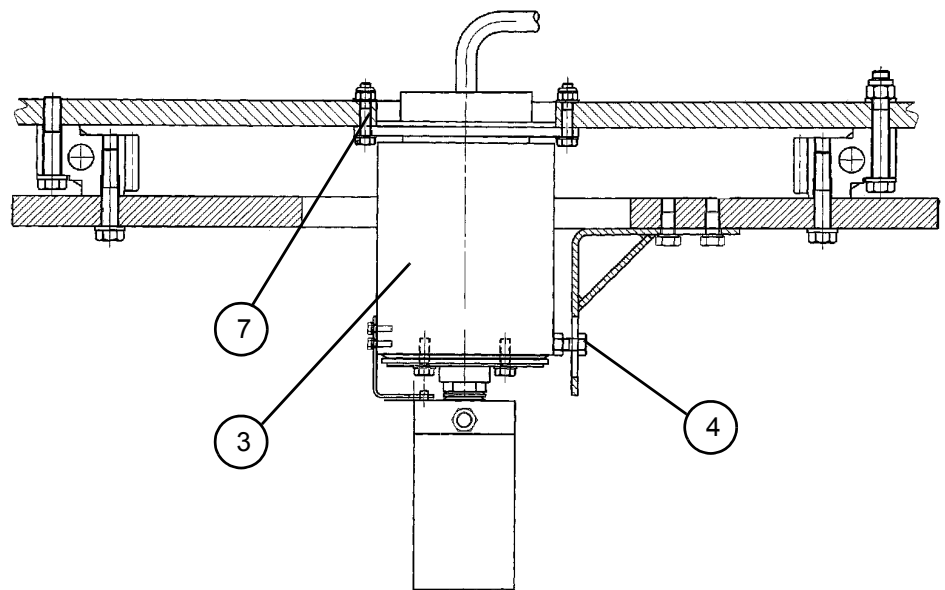
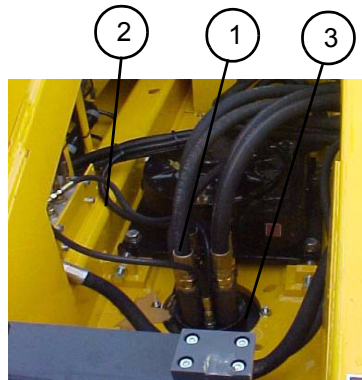

Figure 1

Sheet C104	CORRECTIVE MAINTENANCE SHEET	Folio 1/2
	CHANGING THE BASKET ROTATION GEARING	

1 - Preliminary operations

- Put the machine in the maintenance configuration (see corresponding paragraph).
- Switch off electric power (see corresponding paragraph).
- Remove the basket (see corresponding sheet).
- Remove the basket rotation hydraulic motor (see corresponding sheet).

2 - Removing the gearing

- Remove the motor fixing flange (1).
- Remove the endless screw (2) and the adjusting washers (3), if any.
- Remove the screw (4) and the toothed washer (5).
- Remove the end cap (8), then the platform link part (9) and the Nylatron washer (10).
- Remove the nylostop nut (11), bushing (12), elastic washers (13), plate (14).
- Remove the articulation pin assembly (15) then the disk (16) and pad (17).
- Remove the screws and washers (18) and (19) and remove the pin (15), wormwheel (6), keys (21), hub (20), key (7),

3 - Installing the gearing

- Change the rings, pads and keys if necessary.
- Put into place on the articulation pin (15) the key (7), hub (20) keys (21), wormwheel (6), and put back the screws and washers (18) and (19).
- Put into place the disk (16) and pad (17), then the articulation pin assembly (15).
- Put into place the plate (14), elastic washers (13), bushing (12), then a new nylostop nut (11).
- Put into place the Nylatron washer (10), platform link part (9), end cap (8) and Stauff collar.
- Fix the assembly with the screw (4) equipped with a new toothed washer (5).
- Put back the endless screw (2) and the adjusting washers (3) if necessary.
- Put back the motor fixing flange (1).
- Put back the basket rotation hydraulic motor (see corresponding sheet).
- Put back the basket (see corresponding sheet).
- Lubricate the gearing.

NB: *Only use lubricants recommended by the manufacturer.*

- Put the machine back in the operational configuration.



Caution!

It is essential to put the component in slings before dismantling/re-assembling it.

Sheet C104	CORRECTIVE MAINTENANCE SHEET	Folio 2/2
	CHANGING THE BASKET ROTATION GEARING	

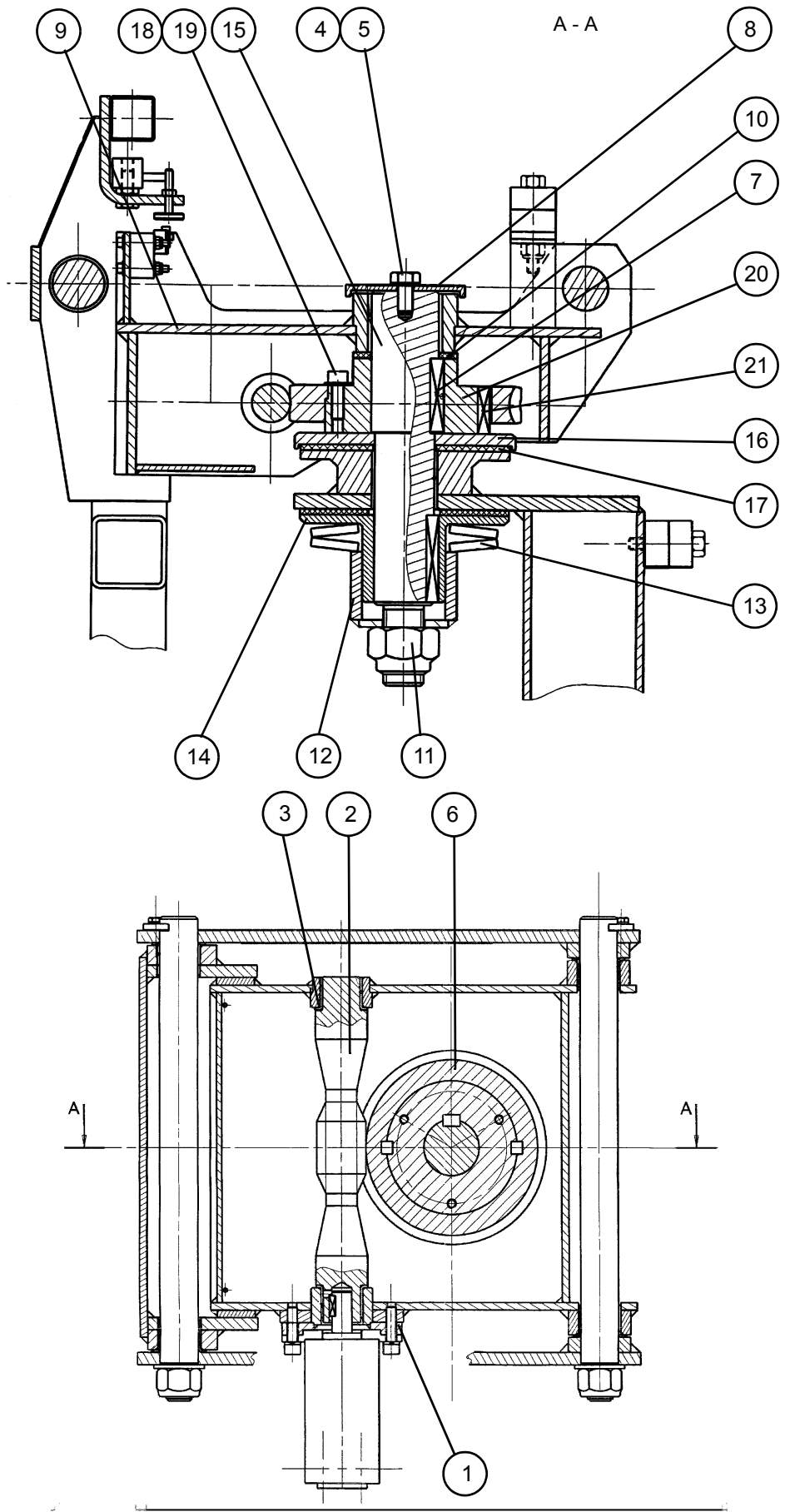

Sheet C106	CORRECTIVE MAINTENANCE SHEET	Folio 1/3
	CHANGING THE SLEW RING	

 **Caution!**
Ensure that the oil is not too hot.

 **Caution!**
Ensure that the lifting equipment is in good condition and of sufficient capacity.

 **Caution!**
Use a container to collect oil to prevent pollution of the environment.

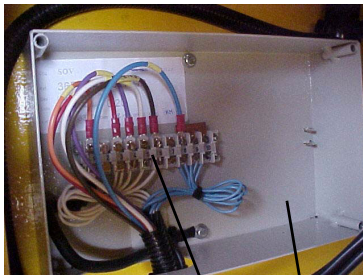

2 1

1 - Preliminary operations

- Move the turntable to the locking position.
- Put the machine in the maintenance configuration (see corresponding paragraph).
- Switch off electric power (see corresponding paragraph).

2 - Removing the slew ring

- Open the chassis box (1), mark and disconnect all electric connectors (2).
- Free the electric wiring harness (3) of the swing joint (4) after marking its path.
- Mark and disconnect the hoses of the swing joint (4) under the chassis (travel motor oil supply and return).

NB: *Unscrew the hoses slowly to release residual hydraulic pressure.*

- Put caps on the hoses.
- Remove the swing joint's rotation stop screw (5).
- Put the turntable in slings and unlock the turntable rotation blocking pin.
- Remove the 24 screws (6) and washers fixing the slew ring to the lower part (7) of the machine.
- Remove the turntable carefully, avoiding damage to the swing joint (4).
- Wedge the ring (8), mark its position in relation to the turntable.
- Remove the 24 screws (9), bolts (10) and washers fixing the slew ring (8) to the turntable.
- Free the turntable.

3 - Installing the slew ring

- Put the slew ring (8) into place on suitable supports in the position marked during dismantling.
- Position the turntable on the ring.
- Fix the ring with the 24 screws (9), bolts (10) and washers without pre-stressing.
- Tighten in a star pattern (see figure 2) to a torque of 27 m.daN (199 lb.ft).
- Place the turntable + ring assembly on the chassis in the locking position.
- Fix the ring (8) to the chassis (7) using the 24 screws (6) and washers without pre-stressing.
- Tighten in a star pattern (see figure 2) to a torque of 27 m.daN (199 lb.ft).
- Remove the slings from the turntable.
- Put back the rotation stop screw (5) of the swing joint (4).
- Reconnect the hoses of the swing joint (4) according to the marks made during dismantling.
- Reconnect the electric connectors (2) of the chassis box (1) according to the marks made during dismantling.
- Adjust the position of the reducing gear (11) using the adjusting screws (12) and (13):
 - Turn the reducing gear to position the ring teeth marked with a colour opposite the reducing gear pinion (this coloured mark corresponds to the most eccentric point of the ring).
 - Adjust the gap between the teeth to 300µm with a set of flakes.
 - When the gap is set, block the counter-nuts of the adjustment screws (12) and (13).

4 - Additional operations

- Put the machine back in the operational configuration.
- Lubricate the ring.

Fiche C106	CORRECTIVE MAINTENANCE SHEET	Folio 2/3
	CHANGING THE SLEW RING	

NB: *Only use lubricants recommended by the manufacturer.*

- Make several turntable rotation, steering and travel movements using all possible travel speeds to purge the hydraulic circuit.
- Check that the electric controls work properly.
- Check the level of the hydraulic oil tank.

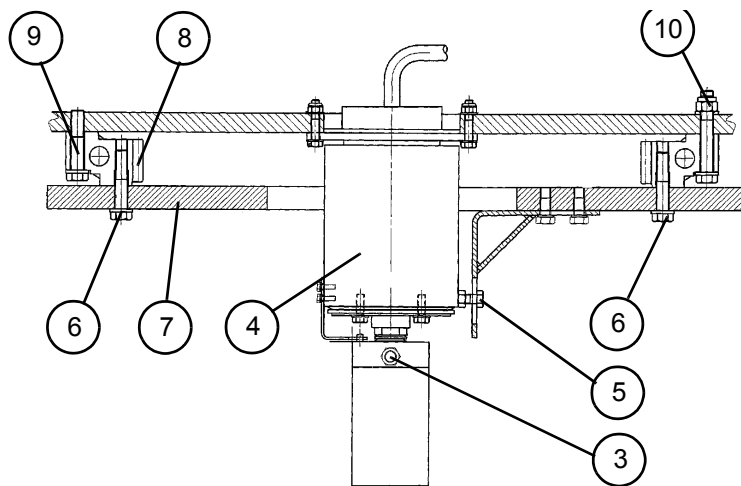

Figure 1

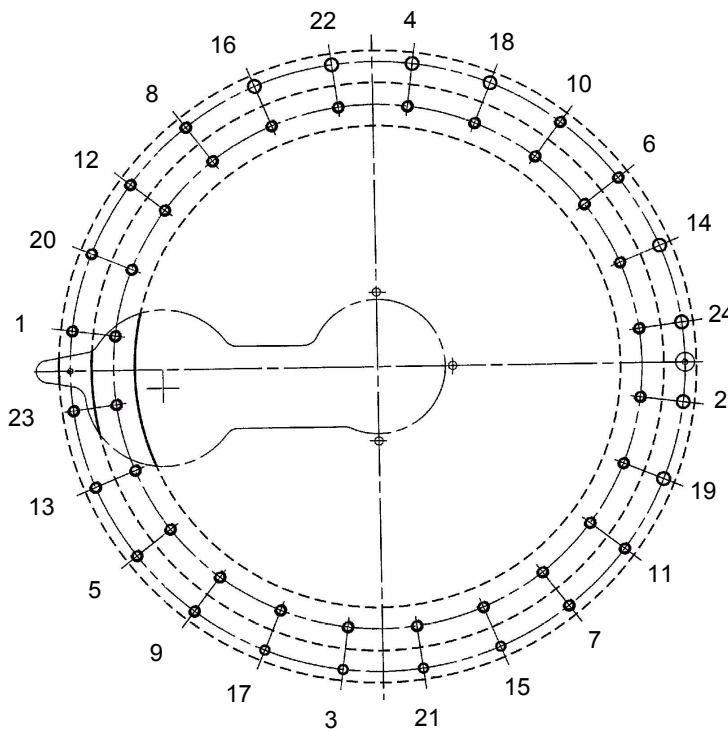
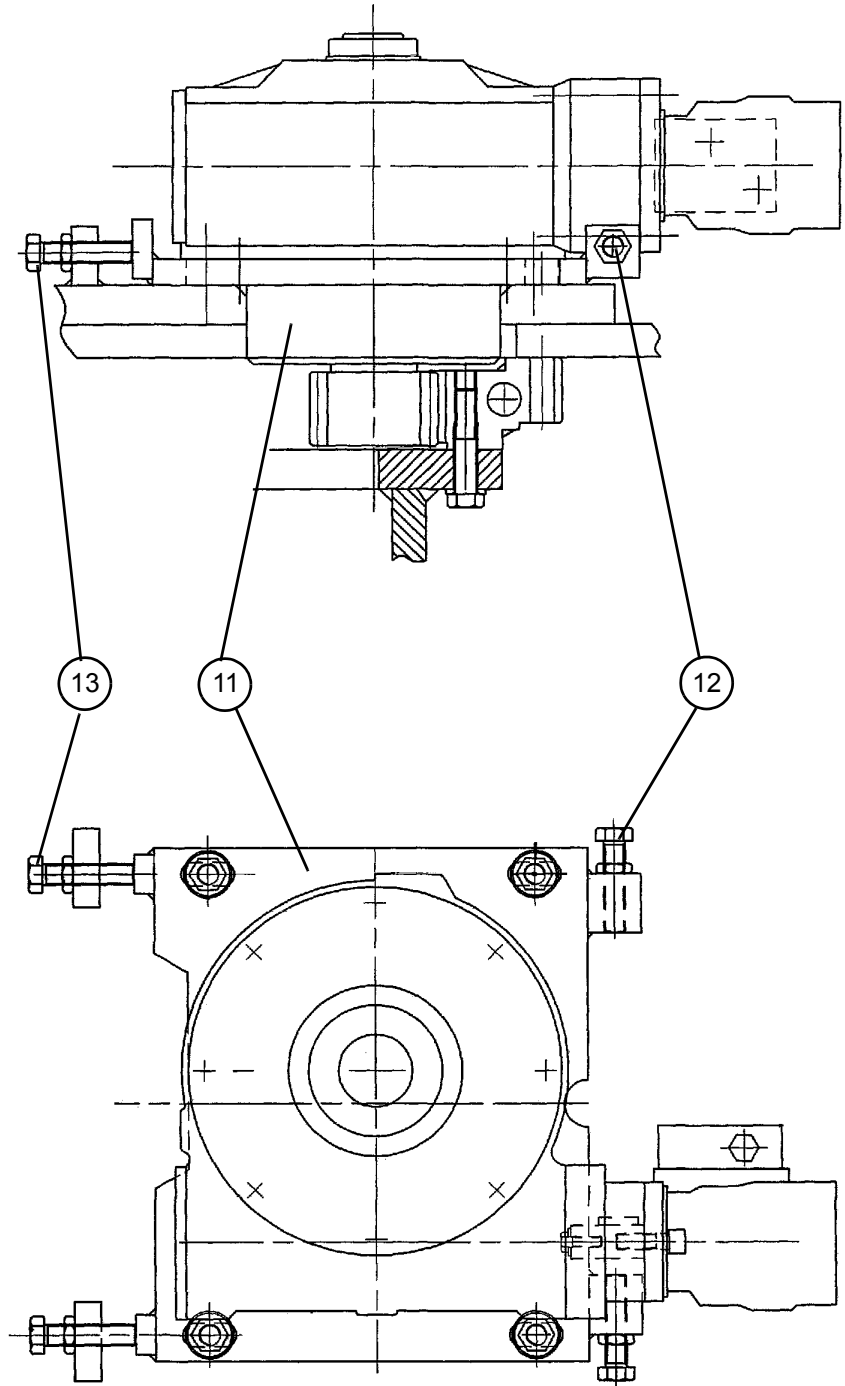

Figure 2

Sheet C106	CORRECTIVE MAINTENANCE SHEET	Folio 3/3
	CHANGING THE SLEW RING	



Sheet C108	CORRECTIVE MAINTENANCE SHEET	Folio 1/1
	CHANGING A CONTROL UNIT OF THE DISTRIBUTION BLOCK	

 **Caution!**
Ensure that the oil is not too hot.

 **Caution!**
Use a container to collect oil to prevent pollution of the environment.

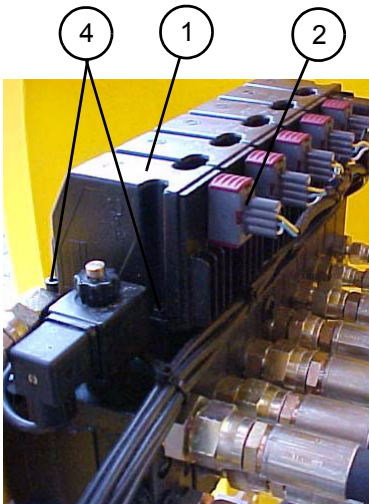

1 - Preliminary operations

- Put the machine in the maintenance configuration (see corresponding paragraph).
- Switch off electric power (see corresponding paragraph).

2 - Removing the coil

- Mark and disconnect the electric connections (2) of the coil (1).
- Remove the coil by removing the fixing screws (4).
- Discard the O-rings (3).

3 - Installing the coil

- Replace the O-rings.
- Put back the coil and fix using fixing screws. Tighten the screws to a torque between 7.5 and 8.5 N.m. (5.53 and 6.26 lb.ft)
- Reconnect the coil's electric connections.
- Check that there is sufficient oil in the hydraulic circuit tank.
- Put the machine back in the operational configuration.
- Test the movement corresponding to the replaced coil. Make several movements to purge the hydraulic circuit.
- Check the level of the hydraulic tank.

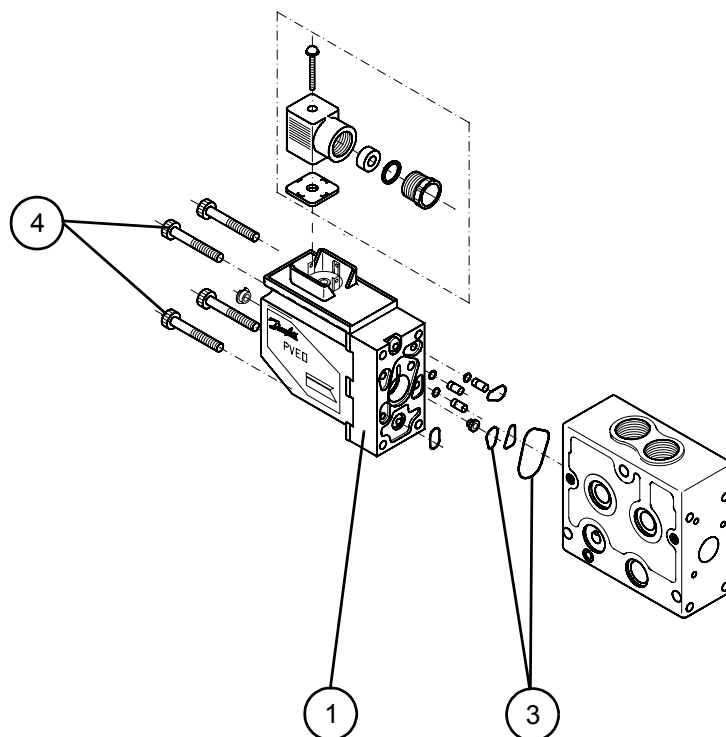

Sheet C109	CORRECTIVE MAINTENANCE SHEET	Folio 1/1
	CHANGING THE EMERGENCY ELECTROPUMP UNIT	

 **Caution!**
Ensure that the oil is not too hot.

 **Caution!**
Use a container to collect oil to prevent pollution of the environment.

1 - Preliminary operations

- Put the machine in the maintenance configuration (see corresponding paragraph).
- Switch off electric power (see corresponding paragraph).
- Disconnect the « - » then « + » terminals of the starter battery.

2 - Removing the emergency electropump unit

- Mark the connections and path of the electric wires (1) of the electropump unit (2).
- Disconnect the electropump unit's electric connections.
- Disconnect the electropump unit's hydraulic hoses (3).

NB: *Unscrew the hoses slowly to release residual hydraulic pressure.*

- Put caps on the hoses.
- Remove the pressure limiter (4) of the emergency hydraulic circuit (see corresponding sheet).
- Unscrew the fixing screws and remove the electropump unit.
- Mark and retain the hydraulic connectors and unions (5) screwed on the electropump unit.

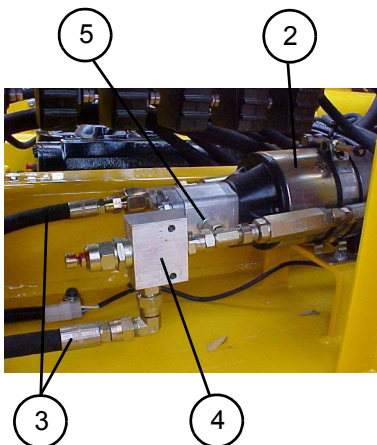

3 - Installing the electropump unit

- Put the hydraulic unions and connectors retained from the removal operation in the same places on a new electropump unit.
- Put back the pressure limiter (see corresponding sheet).
- Put the electropump back into place using the fixing screws.
- Reconnect the hydraulic hoses.
- Reconnect the electric wires according to the marks made during dismantling.
- Reconnect the « + » then « - » terminals of the starter battery.
- Put the machine back in the operational configuration.
- Do not start the thermal motor and trip the emergency electropump unit.
- Make several movements to purge the hydraulic circuit.
- Put the machine back in the operational configuration.
- Check the level of the hydraulic oil tank.

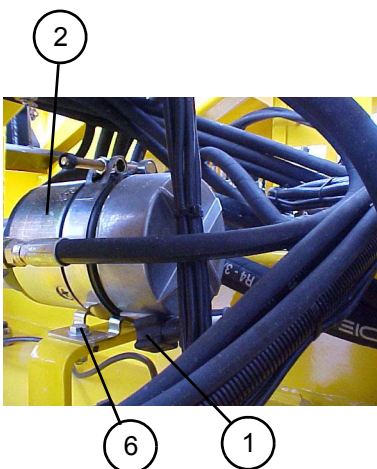

Pinguely-Haulotte

Sheet C114	CORRECTIVE MAINTENANCE SHEET	Folio 1/1
	CHANGING THE EMERGENCY HYDRAULIC CIRCUIT PRESSURE LIMITER	



Attention !

Ensure that the oil is not too hot.



Attention !

Use a container to collect oil to prevent pollution of the environment.

15 - Preliminary operations

- Put the machine in the maintenance configuration (see corresponding paragraph).
- Switch off electric power (see corresponding paragraph).

16 - Removing the emergency circuit pressure limiter

- Disconnect the return hose (1) of the emergency circuit at the pressure limiter (2).

NB: *Unscrew the hoses slowly to release residual hydraulic pressure.*

- Put a cap on the hose.
- Remove the pressure limiter (2) by unscrewing the adapter (3).
- Retain the pressure limiter's union and adapter.

17 - Installing the emergency circuit pressure limiter

- Put the union and adapter on a new pressure limiter.
- Install the pressure limiter by screwing the adapter onto the rigid pipe of the emergency motor.
- Reconnect the hydraulic hose.
- Put the machine back in the operational configuration.
- Do not start the thermal motor and trip the emergency electropump unit.
- Make several movements to purge the hydraulic circuit.
- Adjust the pressure limiter if necessary (see «adjusting a pressure limiter» sheet).
- Put the machine back in the operational configuration.
- Check the level in the hydraulic oil tank.

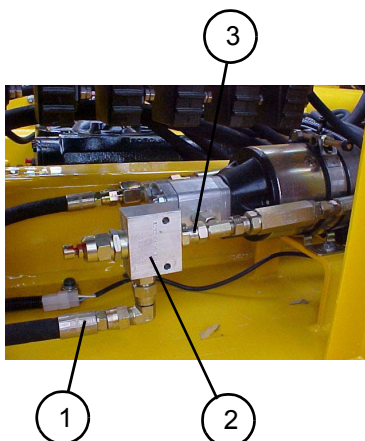

Pinguely-Haulotte

Sheet C115	CORRECTIVE MAINTENANCE SHEET	Folio 1/2
	CHANGING THE JIB CYLINDER	



Caution!
Ensure that the oil is not too hot.



Caution!
Use a container to collect oil to prevent pollution of the environment.



Caution!
It is essential to put the component in slings before dismantling/re-assembling it.

1 - Preliminary operations

- Put the machine in the maintenance configuration (see corresponding paragraph).
- Switch off electric power (see corresponding paragraph).
- Anchor the basket on the ground.

2 - Removing the jib cylinder

- Put the cylinder (1) and jib vertical elements (2) and (3) in slings.
- Mark and disconnect the jib cylinder's two hydraulic hoses.

NB: *Unscrew the hoses slowly to release residual hydraulic pressure.*

- Put caps on the hoses.
- Remove the two bolts and pin stop rings from the cylinder pin (4) on the cylinder body side.
- Remove the pin (4).
- Remove the pin stop clevis from the cylinder pin (5) on the rod side.
- Remove the pin (5).
- Remove the jib cylinder (1).

3 - Installing the jib cylinder

NB: *Before re-installing, check the condition of all articulation pin rings and replace if necessary. Lubricate all bores before re-installing the pins. Only use lubricants recommended by the manufacturer.*

- Put the jib cylinder into place and put back the two articulation pins on the rod and body side of the cylinder.
- Put back the pin stop rings (4) and fix with their bolts.
- Put back the pin stop clevis (5).
- Remove the slings.
- Reconnect the cylinder's hydraulic hoses (1).

4 - Additional operations

- Free the basket.
- Put the machine back in the operational configuration.
- Ensure that there is oil in the hydraulic tank.
- Make several jib movements to test operation and purge the hydraulic circuit.
- Check the level of the hydraulic circuit.

Sheet C115	CORRECTIVE MAINTENANCE SHEET	Folio 2/2
	CHANGING THE JIB CYLINDER	

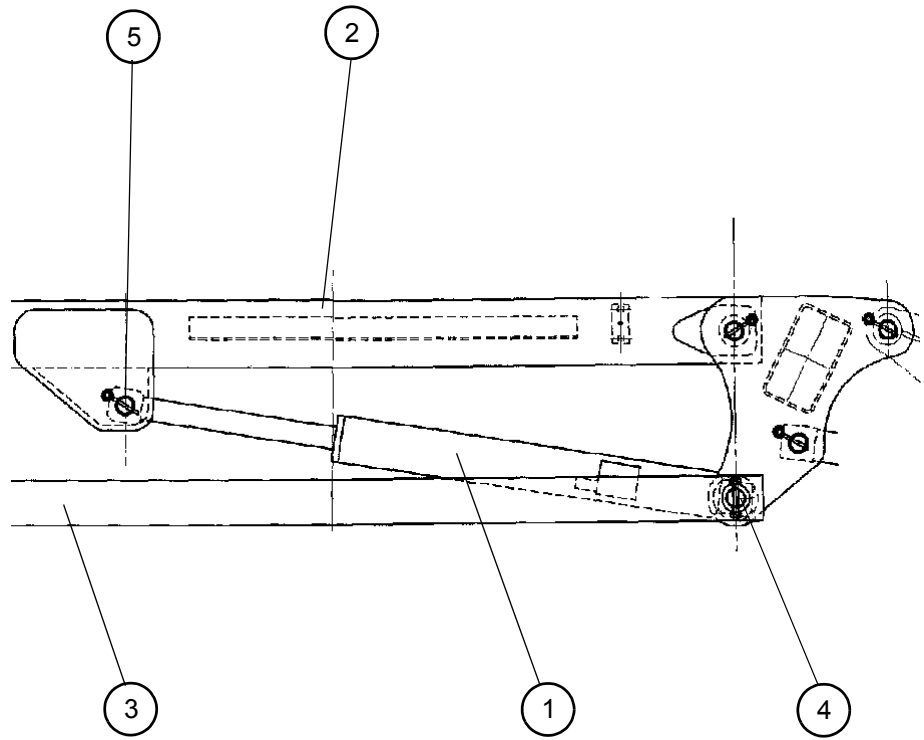

Sheet C117	CORRECTIVE MAINTENANCE SHEET	Folio 1/2
	CHANGING THE TURNTABLE ROTATION REDUCING GEAR	

1 - Preliminary operations

- Lift the boom to enable access to the turntable rotation reducing gear (1).
- Wedge the boom to take its weight (place on firm supports).
- Put the machine in the maintenance configuration (see corresponding paragraph).
- Switch off electric power (see corresponding paragraph).
- Remove the turntable rotation hydraulic motor (5) (see corresponding sheet).



2 - Removing the turntable rotation reducing gear

- Release then unscrew the counter-nuts and screws (2) as far as possible.
- Tighten the screws (2) as far as possible.
- Release the counter-nuts from the two screws (3).
- Unscrew the two screws (3) by a few turns, without removing them.
- Remove the four fixing screws (4) from the turntable rotation reducing gear (1).
- Put in slings then remove the turntable rotation reducing gear (1).
- Remove and retain the adjustment screws (2) with their counter-nuts.

3 - Installing the turntable rotation reducing gear

- Put back the adjustment screws (2) and (3) with their counter-nuts on the new reducing gear (without blocking them) so that the heads are as flush as possible.
- Position the new reducing gear on the turntable.
- Put back the reducing gear's four fixing screws (4) without blocking them.
- Adjust the position of the reducing gear using the adjustment screws (2) and (3):
 - Turn the reducing gear to position the ring teeth marked with a colour opposite the reducing gear pinion (this coloured mark corresponds to the most excentric point of the ring).
 - Adjust the gap between the teeth to 300µm with a set of flakes.
 - When the gap is set, block the counter-nuts of adjustment screws (2) and (3).
- Block the reducing gear's four fixing screws (4) to a torque of 196 N.m (144.56 lb.ft).

4 - Additional operations

- Put back the turntable rotation hydraulic motor (5) (see corresponding sheet).
- Remove the wedges from the boom.
- Put the machine back in the operational configuration.
- Make several turntable rotation movements to purge the hydraulic circuit and check reducing gear operation.
- Check the level of the hydraulic oil tank.

Sheet C117	CORRECTIVE MAINTENANCE SHEET	Folio 2/2
	CHANGING THE TURNTABLE ROTATION REDUCING GEAR	

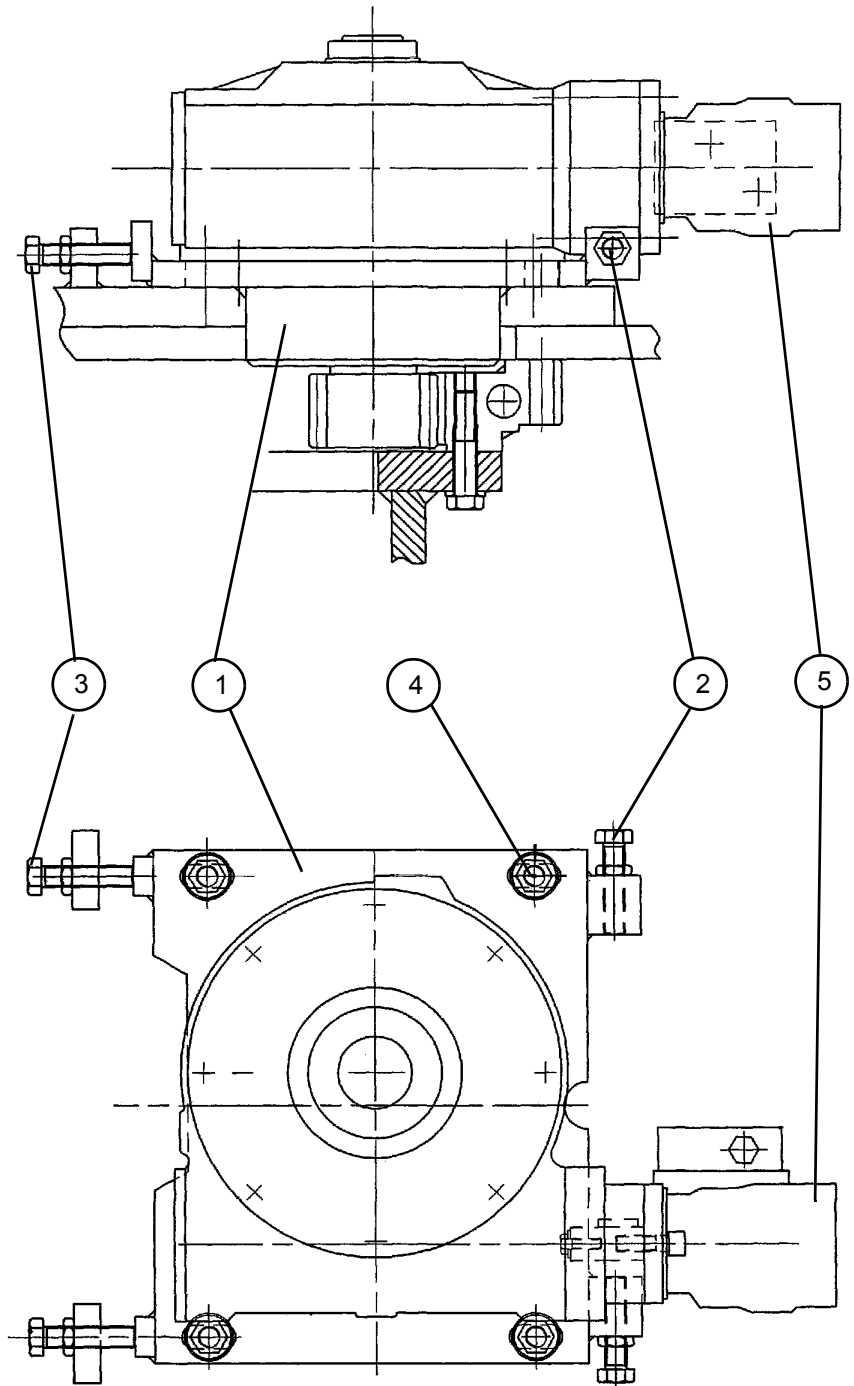

Sheet C132	CORRECTIVE MAINTENANCE SHEET	Folio 1/1
	CHANGING A TURNTABLE COVER	

 **Caution!**
Do not use the machine during maintenance operations.

1 - Preliminary operations

- Put the machine in the maintenance configuration (see corresponding paragraph).
- Switch off electric power (see corresponding paragraph).

2 - Removing a cover

- Open the relevant cover (1).
- Put the cover in slings.
- Remove the gas springs (see corresponding sheet)
- Remove the screws (3) fixing the cover (1) to the two hinges (2).
- Remove the cover.

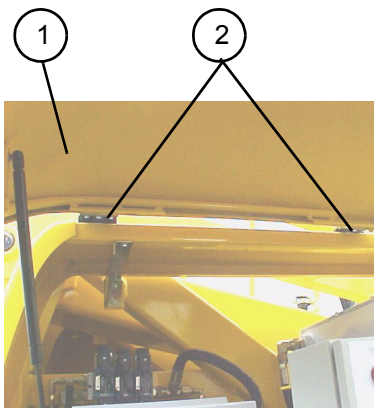

3 - Installing a cover

- Put a new cover into place and fix onto the two hinges (2) using screws (3).
- Install the gas springs (see corresponding sheet).
- Put the machine back in the operational configuration.
- Check that the cover opens and closes properly.
- If necessary, adjust the cover using the screws (3).

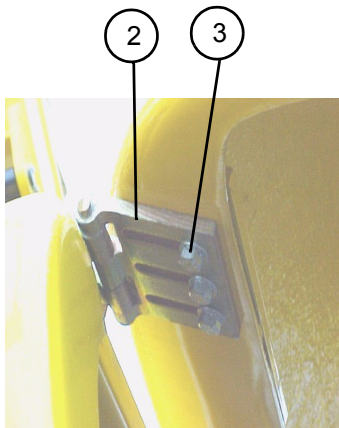

Sheet C133	CORRECTIVE MAINTENANCE SHEET	Folio 1/2
	CHANGING THE THERMAL MOTOR	

⚠ Caution!
Leave the motor and exhaust pipe to cool sufficiently before performing any maintenance operation on these elements.

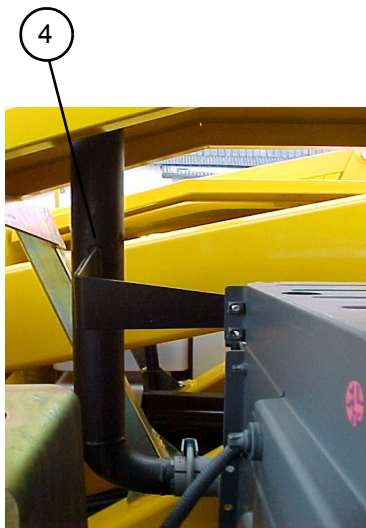
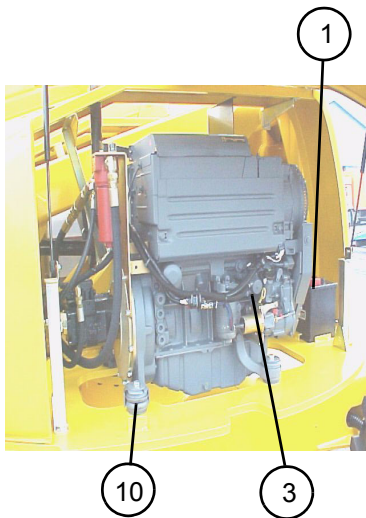

1 - Preliminary operations

- Put the machine in the maintenance configuration (see corresponding paragraph).
- Switch off electric power (see corresponding paragraph).
- Disconnect the «-» then «+» terminals of the starter battery.
- Remove the cover on the motor side (see corresponding sheet).

2 - Removing the connections

- On the motor, disconnect the battery connection cables (1).
- Disconnect the starter connection, the motor's electric connectors (2) and free the duct from the plastic collars.
- Disconnect the fuel incoming (3) and outgoing pipes.
- Remove the hydraulic filter support.

3 - Removing the exhaust

- Remove the exhaust fixing collar.
- Remove the exhaust output pipe (4).

4 - Removing the coupling

- Remove the hydraulic pump (5) (see corresponding sheet).
- Remove the screws (6) fixing the flange (7) of the motor flap, then remove the flange.
- Remove the fixing screws (8) from the coupling plate (9) and remove it.

5 - Removing the thermal motor

- Put the motor in slings according to the instructions in the motor manufacturer's manual.
- Remove the motor's 4 fixing screws (10) and remove the motor.

6 - Installing the thermal motor

- Check the condition of the 4 silent blocks and replace if necessary.
- Put the thermal motor into place and fix using 4 fixing screws, previously coated with normal blue loctite 243, and equipped with new grower washers.

7 - Installing the coupling

- Put the coupling plate into place (9) and fix using fixing screws previously coated with normal blue loctite 243. Tighten to a torque of 25 N.m (18.43 lb.ft)
- Put the motor flap flange into place and fix using screws equipped with new grower washers. Tighten to a torque of 49 N.m (36.14 lb.ft)
- Put back the hydraulic pump (see corresponding sheet).
- Put back the hydraulic filter support assembly.

8 - Connection

- Put into place the exhaust output pipe (4) and fix with the fixing collar.
- Reconnect the fuel incoming and outgoing pipes.
- On the motor, reconnect the electric connectors, the acceleration coil, the starter, motor connections and fix the duct using plastic collars.
- On the motor, reconnect the battery connection cables (1).
- Put back the cover (see corresponding sheet).

Sheet C133	CORRECTIVE MAINTENANCE SHEET	Folio 2/2
	CHANGING THE THERMAL MOTOR	

2

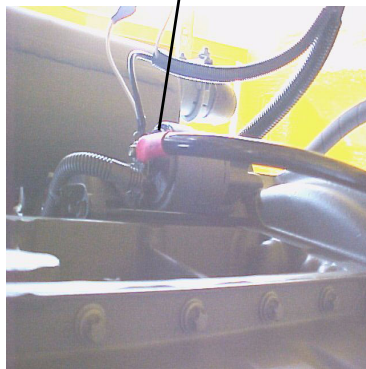

Seen from below towards starter

9 - Additional operations

- Reconnect the «+» then «-» terminals of the starter battery.
- Put the machine back in the operational configuration.
- If the motor installed is new, follow the first commissioning instructions (see motor manufacturer's manual).
- Start the motor and check that it works properly.

11

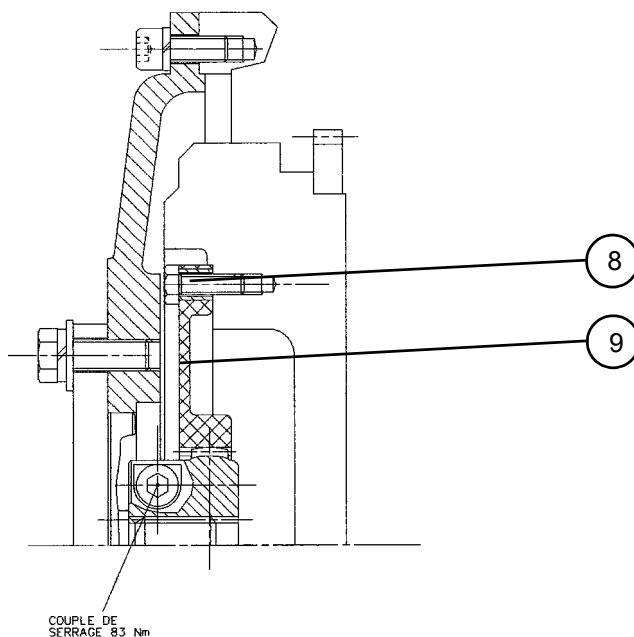
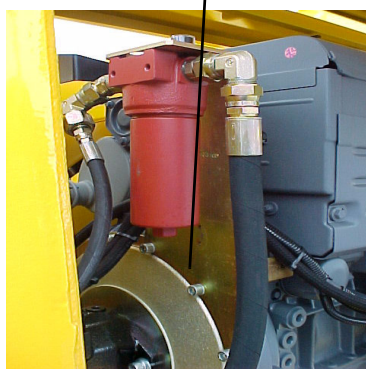

5

7

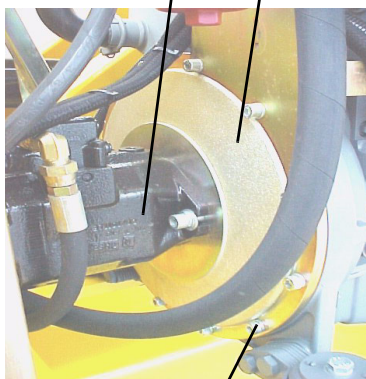

6

Sheet C134	CORRECTIVE MAINTENANCE SHEET	Folio 1/1
	CHANGING THE COUNTERWEIGHTS	

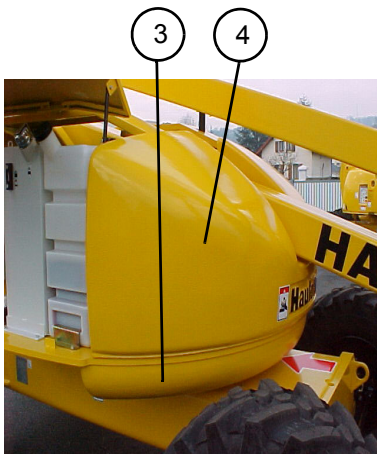

HA26 - HA80

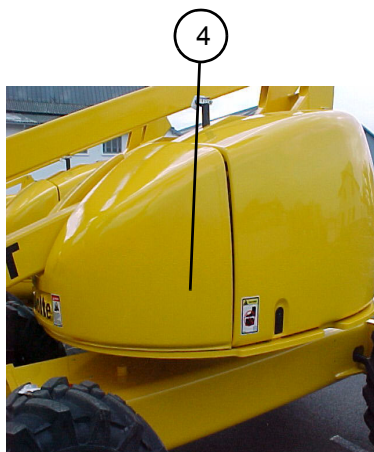

HA20 - HA61

1 - Preliminary operations

- Turn the boom perpendicular to the chassis.
- Raise the arm vertically then turn the wheels as far as possible to change the small counterweight.

PUT THE BOOM IN SLINGS TO WEDGE THE ARM AND PREVENT TIPPING WHEN THE COUNTERWEIGHT(S) IS (ARE) REMOVED.

- Screw the lifting rings onto the counterweight and secure a lifting beam to them.
- Fix a vehicle lift to the lifting beam and apply tension to the vehicle lift.
- Switch off electric power (see corresponding paragraph)

2 - Removing the small counterweight (HA26 - HA80)

- Remove the fixing screws (2) on the small counterweight.
- Remove the small counterweight (3)

3 - Removing the counterweight (HA20/HA26 - HA61/HA80)

- Remove the fixing screws and washers (5).
- Remove the counterweight (4)

4 - Installing the counterweight (HA20/HA26 - HA61/HA80)

- Put the counterweight (4) into place against the stops on the turntable.
- Put back the fixing screws and washers (see table of torque values).

5 - Installing the small counterweight (HA26 - HA80)

- Position the small counterweight (3) using a lifting truck and push up underneath the turntable.
- Fix with the fixing screws (2) and washer (see table of torque values).

6 - Additional operations

- Check that the counterweight is properly secured to the machine.
- Remove the counterweight lifting rings.
- Remove the sling from the boom.
- Put the machine back in the operational configuration.

 **Caution!**
 Ensure that the lifting equipment is in good condition and of sufficient capacity.

 **Caution!**
 It is essential to put the component in slings before dismantling/re-assembling it.

 **Caution!**
 Do not use the machine during maintenance operations.

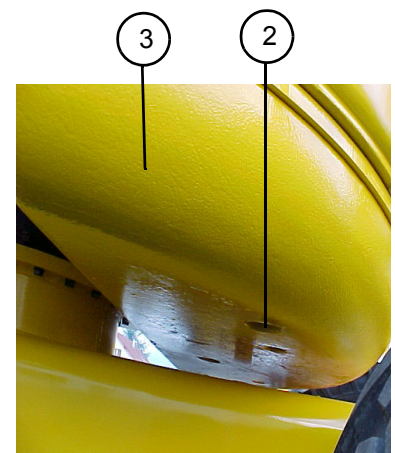
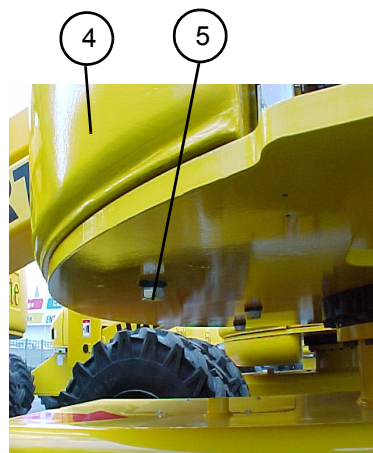

Sheet C134	CORRECTIVE MAINTENANCE SHEET	
	CHANGING THE COUNTERWEIGHTS	